

JPL D-13963, Revision J

Earth Observing System



**Multi-angle
Imaging
Spectro-
Radiometer**

Data Products Specifications

— Incorporating the Science Data Processing Interface Control Document

Scott Lewicki
Catherine Moroney
Kathleen Crean
Scott Gluck
Kyle Miller
Mike Smyth
Susan Paradise

Jet Propulsion Laboratory, California Institute of Technology



Jet Propulsion Laboratory
California Institute of Technology

October 3, 2003



JPL D-13963, Revision J

Multi-angle Imaging SpectroRadiometer (MISR)

Data Products Specifications

— Incorporating the Science Data Processing Interface Control Document

APPROVALS:

David J. Diner

MISR Principal Investigator

Graham Bothwell

MISR Science Data System Manager

Approval signatures are on file with the MISR Project.
To determine the latest released version of this document, consult the MISR web site
(<http://www-misr.jpl.nasa.gov>).

JPL

Jet Propulsion Laboratory
California Institute of Technology





Document Change Log

Revision	Date	Affected Portions and Description
Release A	21 July 1997	All, original release
Release B*	12 March 1998	Section 8: Aerosol/Surface completely redone
Release B	31 September 1998	All, complete update
Release C	14 December 1999	All, complete update for launch
Release D	05 February 2002	All, updates for V2.1.4 Software Delivery. Section 8 change bars are not comprehensive. Geolocation Appendix A. added.
Release E	7 January 2003	All, updates for V2.2 Software Delivery
Release F	14 February 2003	Sections 8, 9: updates for V2.2_i2 Software Delivery
Release G	3 April 2003	Sections 4, 5, 6, 7, 8, 9: updates for V2.2_i5 Software Delivery
Release H	7 April 2003	Sections 8: updates for V2.2_i6 Software Delivery
Release I	10 July 2003	Section 1, 2, 3, and 10: Initial version of Level 3 for V2.2_i10 Software Delivery Section 2: Update applicable product versions
Release J	3 October 2003	Section 6, 7, and 8: updates for V3.0 Software Delivery Section 2: Update applicable product versions

TBD List

Location	Description
Sections 11	Level 3 Joint section is currently empty. It will be completed when L3 data becomes available.



Which Product Versions Does this Document Cover?

Product Filename Prefix	Version Number in Filename	Brief Description	Section
MISR_AM1_CGGRP	F02_0007, F02_0009	L3 Component Global Georectified Product	Sec. [10.0]
MISR_AM1_CGAS	F02_0006, F02_0008	L3 Component Global Aerosol Product	
MISR_AM1_CGLS	F01_0006, F02_0008	L3 Component Global Land/Surface Product	
MISR_AM1_AS_AEROSOL	F06_0013	L2 Aerosol Retrievals	Sec. [8.0]
MISR_AM1_AS_LAND	F04_0013	L2 Land Surface Retrievals	
MISR_AM1_TC_STEREO	F06_0009	L2 Stereo Heights/Winds	Sec. [7.0]
MISR_AM1_TC_CLASSIFIERS	F03_0003	L2 Cloud Classifiers	
MISR_AM1_TC_ALBEDO	F03_0005	L2 Cloud Albedos	
MISR_AM1_GRP_TERRAIN	F02_0016, F02_0017, F02_0018, F02_0019, F02_0020	L1B2 Georectified Radiances	Sec. [6.0]
MISR_AM1_GRP_ELLIPSOID	F02_0016, F02_0017, F02_0018, F02_0019, F02_0020	L1B2 Ellipsoid-Projected Radiances	
MISR_AM1_GRP_TERRAIN_LM	F02_0019 F02_0020	L1B2 Georectified Radiances, Local Mode	
MISR_AM1_GRP_ELLIPSOID_LM	F02_0019 F02_0020	L1B2 Ellipsoid-Projected Radiances, Local Mode	
MISR_AM1_GRP_RCCM		L1 Camera-by-Camera Cloud Mask	
MISR_AM1_GP_GMP	F02_0016, F02_0017, F02_0018, F02_0019, F02_0020	L1 Sun/Camera Angles	
MISR_AM1_ELLIPSOID_GM_BR	F03_0010, F03_0011, F03_0012 F02_0016, F02_0017, F02_0018, F02_0019, F02_0020	L1 JPEG Browse Image	



Product Filename Prefix	Version Number in Filename	Brief Description	Section
MISR_AM1_RP	F02_0016, F02_0017, F02_0018, F02_0019, F02_0020	L1B1 Radiances	Sec. [5.0]
MISR_AM1_FM_SCI	F02_0016, F02_0017, F02_0018, F02_0019, F02_0020	L1A Instrument Data Numbers	Sec. [4.0]
MISR_AM1_FM_MTR	F01_0005 F01_0006	L1A Motor Currents	
MISR_AM1_FM_OBC	F01_0005, F01_0006	L1A On-Board Calibrator Data	
MISR_AM1_FM_ENG	F01_0006, F01_0007	L1A Engineering Data	
MISR_AM1_FM_NAV	0006, 0007	L1A Raw Orbit Navigation Data	
MISR_AM1_FM_CAL	F01_0006, F01_0007	L1A Calibration Experiment Data	
<u>Various</u>		<u>Ancillary Products</u>	Sec. [9.0]
MISR_AM1_ARP_INFLTCAL	F02	Dynamic Rad./Calibration Coefficients	
MISR_AM1_ARP_PRFLTCHAR	F02_0002	Static Preflight Instrument Specs.	
MISR_AM1_ARP_PRFLTCAL	F02_0004, F02_0005	Static Preflight Rad./Calibration Specs.	
MISR_AM1_ARP_CONFIG	F03_0003	Static Calibration Algorithm Data	
MISR_AM1_AGP	F01_24	Geographic Data (DEM)	
MISR_AM1_CGM	F01_0007	Camera Geometric Model	
MISR_AM1_ACP_APOP	F03_0004	Aerosol Climatology (Particle Models)	
MISR_AM1_ACP_MIXTURE	F03_0006	Aerosol Climatology (Particle Mixtures)	





Table of Contents

1.0 MISR DATA PRODUCT SPECIFICATION DOCUMENT.....	19
1.1 OVERVIEW	19
1.2 SCOPE OF MISR DPS DOCUMENT	19
1.3 CONTROLLING DOCUMENTS	21
1.4 APPLICABLE DOCUMENTS.....	22
2.0 MISR SCIENCE DATA PROCESSING	23
2.1 OVERVIEW	23
2.2 MISR SDP: ANCILLARY DATA SET GENERATION	23
2.2.1 MISR SDP Ancillary Data Set Dependencies.....	23
2.2.2 MISR SDP Ancillary Data Sets	24
2.3 MISR SDP: EXTERNAL DATA SET DEPENDENCIES	25
2.4 MISR SDP: STANDARD SCIENCE DATA PRODUCTS	27
3.0 MISR PRODUCTS: FILE FORMAT OVERVIEW	31
3.1 HDF AND HDF-EOS FILE STRUCTURES	31
3.2 MISR PRODUCTS: DATA FORMATS.....	31
3.3 MISR PRODUCTS: METADATA FORMATS.....	34
3.3.1 Structural Metadata	34
3.3.2 Core Metadata	34
3.3.3 Product Metadata.....	34
3.3.4 File Metadata.....	35
3.3.5 Per-grid/Per-swath Metadata.....	35
3.3.6 Per-block Metadata	35
3.4 MISR PRODUCTS: QUALITY ASSURANCE FORMATS	35
3.4.1 QA Fields	36
3.4.2 Standard QA Vdatas and VGroups	37
3.4.3 Special QA Vdatas and VGroups.....	38
4.0 MISR LEVEL 1A REFORMATTED ANNOTATED PRODUCT	41
4.1 MISR LEVEL 1A PRODUCT GRANULE NAMES.....	41
4.2 MISR LEVEL 1A PRODUCT GRANULE BRIEF DESCRIPTIONS	41
4.2.1 MISR LEVEL 1A MI1A CCD Science Instrument Data.....	41
4.2.2 MISR LEVEL 1A MI1AC CCD Calibration Data	42
4.2.3 MISR LEVEL 1A MI1AMOT Motor Data	42
4.2.4 MISR LEVEL 1A MI1ANAV Navigation Data.....	42
4.2.5 MISR LEVEL 1A MI1AENG Engineering Data	42

4.2.6 MISR LEVEL 1A MI1AOBC On-Board Calibration Data	42
4.3 MISR LEVEL 1A PRODUCT GRANULE DATA SETS	43
4.4 MISR LEVEL 1A PRODUCT SHARED SWATH DESCRIPTORS	45
4.5 MISR LEVEL 1A MI1A CCD SCIENCE INSTRUMENT DATA	46
4.5.1 File Metadata Description	46
4.5.2 Per-swath Metadata Description	46
4.5.3 Per-block Metadata Description	46
4.5.4 Per-line Metadata Description	46
4.5.5 Per-pixel Metadata Description	47
4.5.6 Swath Data Set Descriptions	47
4.5.7 CCD Science Product QA	51
4.6 MISR LEVEL 1A MI1AC CCD CALIBRATION DATA	52
4.6.1 File Metadata Description	52
4.6.2 Per-swath Metadata Description	52
4.6.3 Per-block Metadata Description	52
4.6.4 Per-line Metadata Description	52
4.6.5 Per-pixel Metadata Description	53
4.6.6 Swath Data Set Descriptions	53
4.6.7 Per-swath QA Metadata	57
4.7 MISR LEVEL 1A MI1AMOT MOTOR DATA	58
4.7.1 File Metadata Description	58
4.7.2 Per-swath Metadata Description	58
4.7.3 Per-block Metadata Description	58
4.7.4 Per-line Metadata Description	58
4.7.5 Per-pixel (or -sample) Metadata Description	58
4.7.6 Swath Data Set Descriptions	59
4.7.7 Per-swath QA Metadata	61
4.8 MISR LEVEL 1A MI1ANAV NAVIGATION DATA	62
4.8.1 File Metadata Description	62
4.8.2 Per-swath Metadata Description	62
4.8.3 Per-block Metadata Description	62
4.8.4 Per-line Metadata Description	62
4.8.5 Per-pixel (or -sample) Metadata Description	62
4.8.6 Swath Data Set Descriptions	63
4.8.7 Per-swath QA Metadata	65
4.9 MISR LEVEL 1A MI1AENG1 ENGINEERING DATA	66
4.9.1 File Metadata Description	66
4.9.2 Per-swath Metadata Description	66
4.9.3 Per-block Metadata Description	66
4.9.4 Per-line Metadata Description	66
4.9.5 Per-pixel (or -sample) Metadata Description	66
4.9.6 Swath Data Set Descriptions	69
4.9.7 Per-swath QA Metadata	76

4.10 MISR LEVEL 1A MI1AOBC ON-BOARD CALIBRATION DATA	77
4.10.1 File Metadata Description	77
4.10.2 Per-swath Metadata Description	77
4.10.3 Per-block Metadata Description.....	77
4.10.4 Per-line Metadata Description.....	77
4.10.5 Per-pixel (or -sample) Metadata Description	77
4.10.6 Swath Data Set Descriptions	78
4.10.7 Per-swath QA Metadata	82
5.0 MISR LEVEL 1B1 RADIOMETRIC PRODUCT.....	83
5.1 MISR LEVEL 1B1 PRODUCT GRANULE NAMES.....	83
5.2 MISR LEVEL 1B1 PRODUCT GRANULE BRIEF DESCRIPTIONS	83
5.3 MISR LEVEL 1B1 PRODUCT GRANULE DATA SETS	83
5.4 MISR LEVEL 1B1 MI1B1 RADIOMETRIC PRODUCT.....	85
5.4.1 File Metadata Description.	85
5.4.2 Per-swath Metadata Description	85
5.4.3 Per-line Metadata Description.....	86
5.4.4 Per-pixel Metadata Description.....	87
5.4.5 Swath Data Set Descriptions	87
5.4.6 Radiometric Product QA Metadata	89
6.0 MISR LEVEL 1B2 GEORECTIFIED RADIANCE PRODUCT.....	91
6.1 MISR LEVEL 1B2 PRODUCT GRANULE NAMES.....	91
6.2 MISR LEVEL 1B2 GEORECTIFIED RADIANCE PRODUCT GRANULE BRIEF DESCRIPTIONS	91
6.3 MISR LEVEL 1B2 GEORECTIFIED RADIANCE PRODUCT GRANULE DATA SETS	92
6.4 MISR LEVEL 1B2 MI1B2E AND MB2LME ELLIPSOID-PROJECTED PRODUCTS.....	93
6.4.1 File Metadata Description	93
6.4.2 Per-grid Metadata Description	96
6.4.3 Per-block Metadata Description.....	97
6.4.4 Per-line Metadata Description.....	98
6.4.5 Per-pixel Metadata Description.....	98
6.4.6 Grid Data Set Descriptions.....	99
6.4.7 Per-grid QA Metadata	102
6.5 MISR LEVEL 1B2 MI1B2T AND MB2LMT TERRAIN-PROJECTED PRODUCTS.....	103
6.5.1 File Metadata Description	103
6.5.2 Per-grid Metadata Description	105
6.5.3 Per-block Metadata Description.....	106
6.5.4 Per-line Metadata Description.....	107
6.5.5 Per-pixel Metadata Description.....	107
6.5.6 Grid Data Set Descriptions.....	108
6.5.7 Per-grid QA Metadata	111

6.6 MISR LEVEL 1B2 MI1B2GEOP GEOMETRIC PARAMETERS PRODUCT	114
6.6.1 File Metadata Description	114
6.6.2 Per-grid Metadata Description	115
6.6.3 Per-block Metadata Description.....	116
6.6.4 Per-line Metadata Description.....	117
6.6.5 Per-pixel Metadata Description.....	117
6.6.6 Grid Data Set Descriptions.....	117
6.6.7 Per-grid QA Metadata	119
6.7 MISR LEVEL 1B2 MI1B2RCCM RCCM PRODUCT	121
6.7.1 File Metadata Description	121
6.7.2 Per-grid Metadata Description	123
6.7.3 Per-block Metadata Description.....	123
6.7.4 Per-line Metadata Description.....	124
6.7.5 Per-pixel Metadata Description.....	124
6.7.6 Grid Data Set Descriptions.....	124
6.7.7 Per-grid QA Metadata	125
6.8 MISR LEVEL 1B2 MISRBR ELLIPSOID PROJECTED BROWSE PRODUCT.....	127
6.9 MISR LEVEL 1B2 MIB2TRPE ELLIPSOID-PROJECTED TRANSFORM PARAME- TERS PRODUCT	128
6.9.1 File Metadata Description	128
6.9.2 Per-block Metadata Description.....	128
6.9.3 ICC Per-gridcell Metadata Description.....	129
6.9.4 SOM-to-New Per-gridcell and Per-band Metadata Description	130
6.10 MISR LEVEL 1B2 MIB2TRPT TERRAIN-PROJECTED TRANSFORM PARAME- TERS PRODUCT	132
6.10.1 File Metadata Description	132
6.10.2 Per-block Metadata Description.....	132
6.10.3 ICC Per-gridcell Metadata Description.....	133
6.10.4 Ref-to-New Per-subgridcell Metadata Description.....	134
6.10.5 Band-to-Band Per-gridcell and Per-band Metadata Description.....	135
7.0 MISR LEVEL 2 TOA/CLOUD PRODUCT	137
7.1 MISR LEVEL 2 TOA/CLOUD PRODUCT GRANULE NAMES	137
7.2 MISR LEVEL 2 TOA/CLOUD PRODUCT GRANULE BRIEF DESCRIPTIONS ...	137
7.3 MISR LEVEL 2 TOA/CLOUD PRODUCT GRANULE DATA SETS	137
7.4 MISR LEVEL 2 MIL2TCST CLOUD STEREO PRODUCT.....	139
7.4.1 File Metadata Description	139
7.4.2 Per-grid Metadata Description	140
7.4.3 Per-block Metadata Description.....	141
7.4.4 Per-line Metadata Description.....	142
7.4.5 Per-pixel Metadata Description.....	142
7.4.6 Grid Data Set Descriptions.....	142
7.4.7 Per-grid QA Metadata	164



7.5 MISR LEVEL 2 MIL2TCCL CLOUD CLASSIFIER PRODUCT	166
7.5.1 File Metadata Description	166
7.5.2 Per-grid Metadata Description	167
7.5.3 Per-block Metadata Description.....	168
7.5.4 Per-line Metadata Description.....	169
7.5.5 Per-pixel Metadata Description.....	169
7.5.6 Grid Data Set Descriptions.....	169
7.5.7 Per-grid QA Metadata	175
7.6 MISR LEVEL 2 MIL2TCAL CLOUD ALBEDO PRODUCT.....	176
7.6.1 File Metadata Description	176
7.6.2 Per-grid Metadata Description	177
7.6.3 Per-block Metadata Description.....	178
7.6.4 Per-line Metadata Description.....	179
7.6.5 Per-pixel Metadata Description.....	179
7.6.6 Grid Data Set Descriptions.....	179
7.6.7 Per-grid QA Metadata	186
8.0 MISR LEVEL 2 AEROSOL/SURFACE PRODUCT.....	205
8.1 MISR LEVEL 2 A/S PRODUCT GRANULE NAMES	205
8.2 MISR LEVEL 2 A/S PRODUCT GRANULE BRIEF DESCRIPTIONS.....	205
8.3 MISR LEVEL 2 A/S PRODUCT GRANULE DATA SETS.....	207
8.4 MISR LEVEL 2 MIL2ASAE AEROSOL PRODUCT	208
8.4.1 File Metadata Description	208
8.4.2 Vdata Description.....	209
8.4.3 Per-grid Metadata Description	211
8.4.4 Per-block Metadata Description.....	211
8.4.5 Per-line Metadata Description.....	212
8.4.6 Per-pixel Metadata Description.....	212
8.4.7 Grid Data Set Descriptions.....	212
8.4.8 Per-grid QA Metadata	226
8.5 MISR LEVEL 2 MIL2ASLS LAND SURFACE PRODUCT	231
8.5.1 File Metadata Description	231
8.5.2 Vdata Description.....	233
8.5.3 Per-grid Metadata Description	234
8.5.4 Per-block Metadata Description.....	238
8.5.5 Per-line Metadata Description.....	238
8.5.6 Per-pixel Metadata Description.....	239
8.5.7 Grid Data Set Descriptions.....	239
8.5.8 Per-grid QA Metadata	245
8.6 MISR LEVEL 2 MIL2ASOS OCEAN SURFACE PRODUCT	247
8.6.1 File Metadata Description	247
8.6.2 Per-grid Metadata Description	249
8.6.3 Per-block Metadata Description.....	249

8.6.4	Per-line Metadata Description.....	250
8.6.5	Per-pixel Metadata Description.....	250
8.6.6	Grid Data Set Descriptions.....	250
8.6.7	Per-grid QA Metadata	252
9.0	MISR ANCILLARY PRODUCTS	255
9.1	MISR ANCILLARY PRODUCT GRANULE NAMES	255
9.2	MISR ANCILLARY PRODUCT GRANULE BRIEF DESCRIPTIONS	255
9.2.1	MISR Ancillary MIANCAGP Geographic Product.....	255
9.2.2	MISR Ancillary MIANCARP Pre-Flight Characterization Product.....	256
9.2.3	MISR Ancillary MIANCARP Pre-Flight Calibration Product	256
9.2.4	MISR Ancillary MIANCARP In-Flight Calibration Product	256
9.2.5	MISR Ancillary MIANCARP Configuration Product	256
9.2.6	MISR Ancillary MIANCACP APOP Product	257
9.2.7	MISR Ancillary MIANCACP Aerosol Mixture Product.....	257
9.2.8	MISR Ancillary MIANCACP Climatological Likelihood Product	257
9.3	MISR ANCILLARY PRODUCT GRANULE DATA SETS.....	257
9.3.1	MISR Ancillary MIANCAGP Geographic Product.....	257
9.3.2	MISR Ancillary MIANCARP Pre-Flight Characterization Product.....	257
9.3.3	MISR Ancillary MIANCARP Pre-Flight Calibration Product	257
9.3.4	MISR Ancillary MIANCARP In-Flight Calibration Product	258
9.3.5	MISR Ancillary MIANCARP Configuration Product	258
9.3.6	MISR Ancillary MIANCACP APOP Product	258
9.3.7	MISR Ancillary MIANCACP MIXTURE Product	258
9.3.8	MISR Ancillary MIANCACP CLIMLIKE Product	258
9.4	MISR ANCILLARY MIANCAGP GEOGRAPHIC PRODUCT	259
9.4.1	File Metadata Description	259
9.4.2	Per-grid Metadata Description	260
9.4.3	Per-block Metadata Description.....	260
9.4.4	Grid Data Set Descriptions.....	262
9.5	MISR ANCILLARY MIANCARP PRFLTCHAR PRODUCT	264
9.5.1	File Metadata Description	264
9.5.2	Per-SDS Metadata Description	264
9.5.3	Per-block Metadata Description.....	264
9.5.4	Scientific Data Set Descriptions.....	264
9.6	MISR ANCILLARY MIANCARP PRFLTCAL PRODUCT	268
9.6.1	File Metadata Description	268
9.6.2	Per-SDS Metadata Description	268
9.6.3	Per-block Metadata Description.....	268
9.6.4	Scientific Data Set Descriptions.....	268
9.7	MISR ANCILLARY MIANCARP INFLTCAL PRODUCT	271
9.7.1	File Metadata Description	271
9.7.2	Per-SDS Metadata Description	271

9.7.3	Per-block Metadata Description	271
9.7.4	Scientific Data Set Descriptions	271
9.8	MISR ANCILLARY MIANCARP CONFIG PRODUCT	274
9.8.1	File Metadata Description	274
9.8.2	Per-grid Metadata Description	274
9.8.3	Per-block Metadata Description	274
9.8.4	Scientific Data Set Descriptions	274
9.9	MISR ANCILLARY MIANCACP APOP PRODUCT	276
9.9.1	File Metadata Description	276
9.9.2	Per-grid Metadata Description	277
9.9.3	Per-block Metadata Description	277
9.9.4	Vdata Set Descriptions	277
9.9.5	Scientific Data Set Descriptions	281
9.10	MISR ANCILLARY MIANCACP MIXTURE PRODUCT	282
9.10.1	File Metadata Description	282
9.10.2	Per-grid Metadata Description	283
9.10.3	Per-block Metadata Description	283
9.10.4	Vdata Set Descriptions	283
9.10.5	Scientific Data Set Descriptions	285
9.11	MISR ANCILLARY MIANCACP CLIM-LIKELY PRODUCT	285
9.11.1	File Metadata Description	285
9.11.2	Per-grid Metadata Description	285
9.11.3	Per-block Metadata Description	286
9.11.4	Vdata Set Descriptions	286
9.11.5	Scientific Data Set Descriptions	286
10.0	MISR LEVEL 3 COMPONENT PRODUCTS	287
10.1	MISR LEVEL 3 PRODUCT GRANULE NAMES	287
10.2	MISR LEVEL 3 PRODUCT GRANULE BRIEF DESCRIPTIONS	287
10.3	MISR LEVEL 3 PRODUCT GRANULE DATA SETS	287
10.4	MISR LEVEL 3 MIL3MRD, MIL3QRD, MIL3YRD COMPONENT GLOBAL GEO- RECTIFIED PRODUCT	288
10.4.1	File Metadata Description	289
10.4.2	File Dimensions	290
10.4.3	Grid Dataset Description	290
10.5	MISR LEVEL 3 MIL3MAE, MIL3QAE, MIL3YAE COMPONENT GLOBAL AERO- SOL PRODUCT	291
10.5.1	File Metadata Description	292
10.5.2	File Dimensions	293
10.5.3	Grid Dataset Description	293
10.6	MISR LEVEL 3 MIL3MLS, MIL3QLS, MIL3YLS COMPONENT GLOBAL LAND/ SURFACE PRODUCT	294
10.6.1	File Metadata Description	295

10.6.2 File Dimensions.....	296
10.6.3 Grid Dataset Description.....	296
11.0 MISR LEVEL 3 JOINT PRODUCTS.....	299
APPENDIX A: MISR GEOREGISTRATION INFO	301
A.1 Introduction	301
A.2 Background: The Instrument.....	301
A.3 Background: The SOM Projection.....	303
A.4 Background: HDF-EOS	307
A.5 Coordinate Conversions	310
A.5.1 SOM <-> Lat/Lon	310
A.5.2 Inverse: MISR(block, line, sample) -> SOM(X,Y)	311
A.5.3 Forward: SOM(X,Y) -> MISR (block, line, sample)	312
A.6 Metadata Details.....	313
A.7 Example Function Calls	314
A.7.1 misrcoordex.c	316
A.7.2 misr_init.c	321
A.7.3 misrfor.c	322
A.7.4 misrinv.c	323
A.7.5 misrproj.h	324
A.7.6 errormacros.h	324
A.7.7 Makefile	325
A.8 Appendix A Bibliography	325

List of Tables

Table 2-1	MISR SDP Ancillary Data Set Dependencies.....	23
Table 2-2	MISR SDP Ancillary Data Sets.....	24
Table 2-3	MISR SDP External Data Set Dependencies	25
Table 2-4	MISR SDP External Geophysical Parameter Dependencies	26
Table 2-5	MISR Project Standard Science Data Products.....	27
Table 4-1	MISR Level 1A File Granule Names.....	41
Table 4-2	MISR Level 1A Reformatted Annotated Product Files and Swath Datasets	43
Table 4-3	Spatial Resolution Distribution for Global mode	45
Table 4-4	Spatial Resolution Distribution for Local mode	45
Table 4-5	CCD Science Per-Swath Metadata.....	46
Table 4-6	CCD Science Per-Line Metadata.....	46
Table 4-7	CCD Science Swath Field Definitions	47
Table 4-8	CCD Calibration Per-swath Metadata.....	52
Table 4-9	CCD Calibration Per-Line Metadata	52
Table 4-10	CCD Calibration Swath Field Definitions	53
Table 4-11	Motor Per-swath Metadata.....	58
Table 4-12	Motor Data Per-Sample Metadata.....	59
Table 4-13	Motor Data Dimension Descriptions	59
Table 4-14	Motor Data Swath Field Definitions	59
Table 4-15	Swath Data fields for Motor Data	60
Table 4-16	NAVIGATION Per-swath Metadata.....	62
Table 4-17	Navigation Per-Sample Metadata.....	63
Table 4-18	Navigation Data Dimension Descriptions	63
Table 4-19	Navigation Data Swath Field Definitions.....	63
Table 4-20	Swath Data Fields for Navigation Data	64
Table 4-21	Swath Metadata for Engineering Data File	66
Table 4-22	Engineering Data Per-Sample Metadata	67



Table 4-23	Engineering Data Dimension Descriptions	69
Table 4-24	Engineering Data Swath Field Definitions	70
Table 4-25	Swath Data Fields for Engineering Data	72
Table 4-26	Swath Metadata for OBC Data File	77
Table 4-27	OBC Data Per-Sample Metadata.....	78
Table 4-28	OBC Data Dimension Descriptions	78
Table 4-29	OBC Data Swath Field Definitions	79
Table 4-30	Swath Data Fields for Level 1A OBC Data	79
Table 5-1	MISR Level 1B1 File Granule Names	83
Table 5-2	Level 1B1 Radiometric Product File and Swath Datasets.....	84
Table 5-3	Metadata for Radiometric Product Files	85
Table 5-4	Swath Metadata for Radiometric Product Files	86
Table 5-5	Per-line Scene Average for Background Correction	87
Table 5-6	Radiometric Product Field Dimension Descriptions	87
Table 5-7	Spatial Resolution Distribution for Global mode	87
Table 5-8	Spatial Resolution Distribution for Local mode	88
Table 5-9	Radiometric Product Parameter Fill Values.....	88
Table 5-10	Radiometric Product Parameters Swath Field Definitions	89
Table 6-1	MISR Level 1B2 File Granule Names	91
Table 6-2	Level 1B2 Georectified Radiance Product Files and Grid Datasets.....	92
Table 6-3	File Metadata for Ellipsoid-projected TOA Radiance Files.....	93
Table 6-6	Per-grid Metadata for Geometric Parameters and BRF Conversion Factors Grids.	96
Table 6-4	Per-grid Metadata for Ellipsoid-projected TOA Radiance Grids.....	96
Table 6-5	Per-grid Metadata for Ellipsoid-projected TOA Radiance Grids.	96
Table 6-7	PerBlock Metadata for Ellipsoid-projected TOA Radiance File.....	97
Table 6-8	Ellipsoid-projected Grid Data Set Descriptions.....	99
Table 6-9	Spatial Resolution Distribution for Global mode	99
Table 6-10	Ellipsoid-projected TOA Radiance Parameter Fill Values	100
Table 6-11	Ellipsoid-projected Parameters Grid Field Definitions	100

Table 6-12	Geometric Parameter Fill Values.	101
Table 6-13	Geometric Parameters Grid Field Defintions.	101
Table 6-14	BRF Conversion Factors Grid Field Defintions.	102
Table 6-15	Ellipsoid-projected Per-grid QA Metadata.	102
Table 6-16	File Metadata for Terrain-projected TOA Radiance Files.	103
Table 6-17	Per-grid Metadata for Terrain-projected TOA Radiance Grids.	105
Table 6-18	Per-grid Metadata for Terrain-projected TOA Radiance Grids.	105
Table 6-19	Per-grid Metadata for Geometric Parameters and BRF Conversion Factors Grids. ..	105
Table 6-20	Per-block Metadata for Terrain-projected TOA Radiance File.	106
Table 6-21	Terrain-projected Grid Data Set Descriptions.	108
Table 6-22	Spatial Resolution Distribution for Global mode	108
Table 6-24	Terrain-projected Parameters Grid Field Definitions.	109
Table 6-23	Terrain-projected TOA Radiance Parameter Fill Values.	109
Table 6-25	Geometric Parameter Fill Values.	110
Table 6-26	Geometric Parameters Grid Field Defintions.	110
Table 6-27	BRF Conversion Factors Grid Field Defintions.	111
Table 6-28	Terrain-projected Per-grid QA Metadata.	111
Table 6-29	File Metadata for Geometric Parameters Product Files.	114
Table 6-30	Per-grid Metadata for Geometric Parameters Product Files.	115
Table 6-31	Per-block Metadata for Geometric Parameters Product Files.	116
Table 6-33	Geometric Parameter Fill Values.	117
Table 6-32	Geometric Parameters Product Field Dimension Descriptions	117
Table 6-34	Geometric Parameters Grid Field Definitions.	118
Table 6-35	File Metadata for RCCM Product Files.	121
Table 6-36	Per-grid Metadata for RCCM Product Files.	123
Table 6-37	Per-block Metadata for RCCM Product Files.	123
Table 6-38	Georectified Radiance Product Field Dimension Descriptions.	124
Table 6-39	Spatial Resolution Distribution for Global mode	124
Table 6-40	RCCM Parameters Grid Field Definitions.	125



Table 6-41	RCCM Per-grid QA Metadata.....	125
Table 6-42	Additional File Metadata for Ellipsoid-Projected Transform Parameter Files.	128
Table 6-43	L1B1 Extent Per-block Metadata for Ellipsoid-Projected Transform Parameter Files....	128
Table 6-44	ICC Per-gridcell Metadata for Ellipsoid-Projected Transform Parameter Files.	129
Table 6-45	SOM-to-New Per-gridcell and Per-band Metadata for Ellipsoid-Projected Transform Parameter Files.....	130
Table 6-46	Additional File Metadata for Terrain-Projected Transform Parameter Files.	132
Table 6-47	L1B1 Extent Per-block Metadata for Terrain-Projected Transform Parameter Files.	132
Table 6-48	ICC Per-gridcell Metadata for Terrain-Projected Transform Parameter Files.....	133
Table 6-49	Ref-to-New Per-subgridcell Metadata for Terrain-Projected Transform Parameter Files.	134
Table 6-50	Band-to-Band Per-gridcell and Per-band Metadata for Terrain-Projected Transform Parameter Files.....	135
Table 7-1	MISR Level 2 TOA/CLOUD File Granule Names.	137
Table 7-2	Level 2 TOA/CLOUD Product Files and Grid Datasets.....	138
Table 7-3	File Metadata for Cloud Stereo Product Files.	139
Table 7-4	Per-grid Metadata for Cloud Stereo Product Files.	140
Table 7-5	Per-block Metadata for Cloud Stereo Product Files.....	141
Table 7-6	Cloud Stereo Product Field Dimension Descriptions.....	142
Table 7-7	Cloud Stereo Product Grid Dataset Descriptions.	143
Table 7-8	Per-grid QA Metadata for Cloud Stereo Products.	164
Table 7-9	File Metadata for Cloud Classifier Product Files.....	166
Table 7-10	Per-grid Metadata for Cloud Classifier Product Files.	167
Table 7-11	Per-block Metadata for Cloud Classifier Product Files.....	168
Table 7-12	Cloud Classifier Product Field Dimension Descriptions.....	169
Table 7-13	Cloud Classifier Product Grid Dataset Descriptions.....	170
Table 7-14	Per-grid QA Metadata for Cloud Classifier Products.....	175
Table 7-15	File Metadata for Cloud Albedo Product Files.....	176
Table 7-16	Per-grid Metadata for Cloud Albedo Product Files.....	177

Table 7-17	Per-block Metadata for Cloud Albedo Product Files.	178
Table 7-18	Cloud Albedo Product Field Dimension Descriptions	179
Table 7-19	Cloud Albedo Product Grid Dataset Descriptions.....	180
Table 7-20	Per-grid QA Metadata for Cloud Albedo Products.	186
Table 8-1	MISR Level 2 Aerosol/Surface File Granule Names.	205
Table 8-2	Surface-Atmosphere Radiation Interaction Terms	206
Table 8-3	Level 2 Aerosol/Surface Product Files and Grid Datasets.	207
Table 8-4	File Metadata for Aerosol Product Files.	208
Table 8-5	Aerosol Product File Vdata Summary.....	210
Table 8-6	Per-grid Metadata for Aerosol Product Files.....	211
Table 8-7	Per-block Metadata for Aerosol Product Files.	211
Table 8-8	Aerosol Product Field Dimension Descriptions.	213
Table 8-9	Aerosol Product Grid Dataset Descriptions, part I.....	214
Table 8-9	Aerosol Product Grid Dataset Descriptions, part II.....	220
Table 8-10	Per-grid QA Metadata for Aerosol Products.	226
Table 8-11	File Metadata for Land Surface Product Files.....	231
Table 8-12	Land Surface Product File Vdata Summary	233
Table 8-13	Per-grid Metadata for Land Surface Product Files.....	234
Table 8-14	Per-block Metadata for Land Surface Product Files.	238
Table 8-15	Land Surface Product Field Dimension Descriptions	239
Table 8-16	Land Surface Product Grid Dataset Descriptions.....	240
Table 8-17	Per-grid QA Metadata for Land Surface Products.	245
Table 8-18	File Metadata for Ocean Surface Product Files.....	247
Table 8-19	Per-grid Metadata for Ocean Surface Product Files.....	249
Table 8-20	Per-block Metadata for Ocean Surface Product Files.	249
Table 8-22	Ocean Surface Product Grid Dataset Descriptions.....	251
Table 8-21	Ocean Surface Product Field Dimension Descriptions.	251
Table 8-23	Per-grid QA Metadata for Ocean Surface Products.	252
Table 9-1	MISR Ancillary File Granule Names.	255

Table 9-2	Ancillary Product Files and Grid Datasets.	258
Table 9-3	File Metadata for Ancillary Geographic Product Files.	259
Table 9-4	Per-grid Metadata for Ancillary Geographic Product Files.	260
Table 9-5	Per-block Metadata for Ancillary Geographic Product Files.	260
Table 9-6	Ancillary Geographic Product Field Dimension Descriptions.	262
Table 9-7	Ancillary Geographic Product Grid Dataset Descriptions.	262
Table 9-8	File Metadata for Ancillary Radiometric Pre-Flight Char Product Files.	264
Table 9-9	ARP: Preflight characterization data.	265
Table 9-10	File Metadata for Ancillary Radiometric PRFLTCAL Product Files.	268
Table 9-11	File Metadata for Ancillary Radiometric INFLTCAL Product Files.	271
Table 9-12	ARP: In-flight calibration data.	272
Table 9-13	File Metadata for Ancillary Radiometric CONFIG Product Files.	274
Table 9-14	Global Attributes	276
Table 9-15	APOP Vdata Summary	277
Table 9-16	Summary Table Fields	279
Table 9-17	Input Component Particle Types Fields	279
Table 9-18	Data Table Fields	280
Table 9-19	Bands Fields	281
Table 9-20	Hydrated Relative Humidities Fields	281
Table 9-21	Scattering Angles Fields	281
Table 9-22	APOP SDS Summary	282
Table 9-23	Global Attributes	282
Table 9-24	APOP Vdata Summary	283
Table 9-25	Mixture Data Fields	284
Table 9-26	Component Model Legends Fields	284
Table 9-27	Bands Fields	284
Table 9-28	Retrieval Path Indices Fields	284
Table 9-29	Retrieval Path Applicability Flag Legend Fields	285
Table 9-30	Mixture SDS Summary	285

Table 10-1	MISR Level 3 File Granule Names	287
Table 10-2	Level 3 Component Global Product Files and Grid Datasets.....	288
Table 10-3	CGGRP File metadata	289
Table 10-4	CGGRP File Dimensions	290
Table 10-5	CGGRP Grid Dataset Description.....	290
Table 10-6	CGAS File metadata.....	292
Table 10-7	CGAS File Dimensions	293
Table 10-8	CGAS Grid Dataset Description	293
Table 10-9	CGLS File metadata	295
Table 10-10	CGLS File Dimensions.....	296
Table 10-11	CGLS Grid Dataset Description.....	296
Table A-1	MISR Metadata Sources	314





Acronym List

AU.....	Astronomical Unit
BHR	Bihemispherical Reflectance
BRF.....	Bidirectional Reflectances
DHR	Directional Hemispherical Reflectance
DHRPAR	DHR integrated over Photosynthetically Active Radiation band.
EOS.....	Earth Observing System
EOSDIS.....	Earth Observing System Data and Information System
ESDT.....	Earth Science Datatype
FPAR	Fraction of Photosynthetically-Active Radiation
GDQI.....	Geometric Data Quality Indicator
HDRF.....	Hemispherical-Directional Reflectance Factor
JPL	Jet Propulsion Laboratory
LAI.....	Leaf Area Index
NASA.....	National Aeronautics and Space Administration
NDVI.....	Normalized Difference Vegetation Index
SCF	Science Computing Facility
SDP	Science Data Processing
SMART.....	Simulated MISR Ancillary Radiative Transfer
SOM.....	Space-Oblique Mercator
TOA	Top-Of-Atmosphere
TOAC.....	Tropical Ocean Atmospheric Correction
WGS84.....	World Geodetic System 1984





1.0 MISR DATA PRODUCT SPECIFICATION DOCUMENT

1.1 OVERVIEW

The Multi-angle Imaging SpectroRadiometer (MISR) project is a component of the Earth Observing System (EOS) Terra Mission and the EOS Data Information System (EOSDIS), which in themselves are components of the National Aeronautics and Space Administration's (NASA) Earth Science Enterprise. An integral part of the MISR project is Scientific Data Processing (SDP) of the observations coming from the MISR instrument on-board the EOS-TERRA satellite.

MISR SDP exists to produce science and supporting data products from MISR instrument data. All functions of the MISR SDP system are directed toward this goal. MISR SDP does not operate as an independent entity, but rather is linked to the functionality of the EOSDIS at the Langley Research Center (LaRC) Distributed Active Archive Center (DAAC). The ECS ingest subsystem at the LaRC DAAC is the agent for receiving and organizing all of the input data needed by MISR SDP. These data are then made available to MISR SDP through the data server and staging facilities provided by ECS at the LaRC DAAC. After MISR standard data processing is complete, the standard output products are archived through the EOSDIS data server and made available to users through ECS client services.

The MISR Science Computing Facility (SCF) at the Jet Propulsion Laboratory (JPL) supports the development of MISR science algorithms and software, instrument calibration and performance assessment, as well as providing quality assessment and data validation services with respect to MISR SDP. The MISR SCF produces software, supporting data, and coefficients that are required to operate MISR SDP software at the LaRC DAAC.

MISR SDP processing depends upon the availability of MISR instrument data, internal data sets produced by the MISR SCF, and external data sets that are products of other EOS data processing systems. The main purpose of this document is to describe MISR standard output products of the EOSDIS, as well as required internal and external data sets that are critical to MISR SDP. This document is not meant to be the definitive description of the external data sets that are products of other EOS data processing systems and utilized by MISR SDP. Rather, it only describes the external data sets that MISR requires for its processing. The full range of internal data sets produced at the MISR Science Computing Facility (SCF) are not described in this document either, except for the three internal data sets that are produced as ancillary products and included in the MISR standard output products. For details of the other internal data sets, see the MISR Software Interface Specification (SIS) document for internal interfaces and the Data Management Plan (DMP), which describes MISR SCF activities in regard to archiving data at the MISR SCF.

1.2 SCOPE OF MISR DPS DOCUMENT

The input data sets that are generated internally within the MISR project and the external data sets from outside the MISR project that are critical to MISR SDP are first described in section 2. This section clearly highlights MISR SDP dependencies on data sets generated externally to the MISR

project. The final outputs of MISR SDP are surface, aerosol, and cloud data products based on the MISR EOS-TERRA observations, together with three supporting ancillary data products that aid in the interpretation of the geophysical data sets.

In section 3 of the DPS document the general file structure of all MISR SDP geophysical and ancillary data products is described. In particular, MISR SDP dependence on both HDF-EOS swath and grid formats is discussed, together with the HDF and HDF-EOS structures that MISR SDP uses to store metadata. The file formats of each MISR geophysical and ancillary data product are then explained in detail, including the

- MISR LEVEL 1A REFORMATTED ANNOTATED PRODUCT (section 4),
- MISR LEVEL 1B1 RADIOMETRIC PRODUCT (section 5),
- MISR LEVEL 1B2 GEORECTIFIED RADIANCE PRODUCT (section 6) ,
- MISR LEVEL 2 TOA/CLOUD PRODUCT (section 7),
- MISR LEVEL 2 AEROSOL/SURFACE PRODUCT (section 8),
- MISR ANCILLARY GEOGRAPHIC PRODUCT (section 9),
- MISR ANCILLARY RADIOMETRIC PRODUCT (section 9),
- MISR ANCILLARY AEROSOL CLIMATOLOGY PRODUCT (section 9).
- MISR COMPONENT GLOBAL GEORECTIFIED PRODUCT (section 10).
- MISR COMPONENT GLOBAL AEROSOL PRODUCT (section 10).
- MISR COMPONENT GLOBAL LAND/SURFACE PRODUCT (section 10).

The three ancillary products described in section 9 are actually produced at the MISR SCF, but they are archived at the LaRC DAAC because these products are needed to fully understand and interpret the MISR SDP standard output products.

Appendix [A] contains a description of a method for obtaining the latitude and longitude of a MISR pixel. Since most MISR data products are registered to the SOM map projection, it is important to understand the conversions in the Appendix in order to compare MISR products to data from other sources.



1.3 CONTROLLING DOCUMENTS

- 1) MISR Science Data Processing Functional Requirements Document, (FRD) JPL D-12417, September 1996 (or latest version).
- 2) MISR Experiment Implementation Plan, Volume III, Science, Data Processing, and Instrument Operations, Technical and Management Plan (EIP), JPL D-11520, 24 January 1996 (or latest version).
- 3) MISR Science Data System Software Management Plan (SMP), JPL D-11641, February 1996 (or latest version).
- 4) SDPIO Implementation Handbook, JPL D-16392, January 1999 (or latest version).
- 5) MISR Data System Science Requirements, JPL D-11398, September 1996 (or latest version).
- 6) MISR Level 1 Radiance Scaling and Conditioning Algorithm Theoretical Basis, JPL D-11507, Revision D, January 1999 (or latest version).
- 7) MISR Level 1 Georectification and Registration Algorithm Theoretical Basis, JPL D-11532, Revision B, August 1996 (or latest version).
- 8) MISR Level 1 Cloud Detection Algorithm Theoretical Basis, JPL D-13397, Revision A, November 1997 (or latest version).
- 9) MISR Level 1 In-flight Radiometric Calibration and Characterization Algorithm Theoretical Basis, JPL D-13398, June 1996 (or latest version).
- 10) MISR Level 1 Ancillary Geographic Product Algorithm Theoretical Basis, JPL D-13400, Revision B, March 1999 (or latest version).
- 11) MISR Level 2 Top-of-Atmosphere Albedo Algorithm Theoretical Basis, JPL D-13401, Revision C, December 1997 (or latest version).
- 12) MISR Level 2 Aerosol Retrieval Algorithm Theoretical Basis, JPL D-11400, Revision C, December 1997 (or latest version).
- 13) MISR Level 2 Surface Retrieval Algorithm Theoretical Basis, JPL D-11401, Revision C, December 1997 (or latest version).
- 14) MISR Level 2 Ancillary Products and Datasets Algorithm Theoretical Basis, JPL D-13402., Revision A, December 1998 (or latest version).
- 15) MISR Level 3 Global Products Algorithm Theoretical Basis, JPL D-14190, June 2000 (or latest version).
- 16) MISR Science Data Quality Indicators, JPL D-13496, January 1997 (or latest version).
- 17) Data Production Software and Science Computing Facility (SCF) Standards and Guidelines, GSFC EOSDIS document 423-16-01

- 18) MISR Science Data Processing Quality Assessment Plan, JPL D-13965, 17 January 1997 (or latest version).

1.4 APPLICABLE DOCUMENTS

- 19) Science User's Guide and Operations Procedure Handbook for the ECS Project, HAIS 193-205-SE1-001 (or latest version).
- 20) Interface Requirements Document Between EOSDIS Core System (ECS) and Science Computing Facilities, HAIS 209-CD-005-005, March 1996 (or latest version).
- 21) EOSDIS Core System Science Information Architecture, HAIS working paper FB9401V2 (or latest version).
- 22) Software Implementation Guidelines, JPL D-10622 (or latest version).
- 23) MISR Science Data System Error Policy, JPL D-13137 (or latest version).
- 24) Statement of Work for the Multi-Angle Imaging SpectroRadiometer (MISR), GSFC 421-12-13-03 (or latest version).
- 25) MISR Mission Operations Concepts and Requirements, JPL D-11594 (or latest version).
- 26) SDP Toolkit Users Guide for the ECS Project, HAIS 194-809-SD4-001 (or latest version).

2.0 MISR SCIENCE DATA PROCESSING

2.1 OVERVIEW

Multi-angle Imaging SpectroRadiometer (MISR) science data processing (SDP) at the Langley Research Center (LaRC) Distributed Active Archive Center (DAAC) requires data sets generated internally by the MISR Science Computing Facility (SCF), as well as external data sets generated outside of the MISR project. The internal data sets generated by the MISR SCF are called ancillary data sets.

The data sets that are required by the MISR SCF in order to produce the internal data sets required by MISR SDP at the LaRC DAAC are discussed in section 2.2.1, while the internal data sets actually generated at the MISR SCF are listed in section 2.2.2. Both MISR SCF generated internal data sets and external data sets (section 2.3) are required in MISR SDP at the LaRC DAAC. MISR SDP at the LaRC DAAC operates on the internal and external data sets to produce the MISR project standard science data products (section 2.4).

2.2 MISR SDP: ANCILLARY DATA SET GENERATION

The required data sets to MISR SCF generation of the internal data sets are illustrated in Table 2-1. The internal data sets generated by MISR SCF processing (Table 2-2) are archived at the MISR SCF, sent to the LaRC DAAC to be archived, and then used as inputs to MISR SDP at the LaRC DAAC. Henceforth, we call these internal data sets generated by the MISR SCF Ancillary Data Sets and Products.

NOTE: At launch time MISR SDP at the LaRC DAAC will use only the MISR SCF generated Ancillary Data Sets and Products as inputs for the processing. Usage of the external data sets will come later.

2.2.1 MISR SDP Ancillary Data Set Dependencies

Table 2-1: MISR SDP Ancillary Data Set Dependencies

Input Data Sets Required for MISR SDP
Spacecraft Ancillary Data
Predicted Spacecraft Orbit
Preflight DataBRDF Cloud Threshold Models
ISCCP Climatologies
Radiometric Calibration Reference Imagery

Geometric Calibration Reference Imagery
Coastline Reference Maps
Global Digital Elevation Model
SAGE Climatology Record
TOMS Climatology Record
Flight and Ground Cross Comparisons
Solar Irradiance Model
Earth-Sun Ephemeris
Aerosol Models
NSIDC Snow-Ice cover
DAO Atmospheric Data
DAO Atmospheric Data
DAO Atmospheric Data
AVIRIS Reference Imagery
Global Aerosol Climatologies

2.2.2 MISR SDP Ancillary Data Sets

 = Not yet implemented

Table 2-2: MISR SDP Ancillary Data Sets

Product	ESDTs	File Description
Ancillary Radiometric Product	MIANCARP	ARP
Radiometric Camera-by-camera Cloud Thresholds	MIANRCCT	RC Thres.
Cloud Screening Surface Classification Dataset	MIANCSSC	CSSC
Ancillary Geographic Product	MIANCAGP	AGP
Camera Geometric Model	MISANCGM	CGM
Projection Parameters	MIANPP	PP

Table 2-2: MISR SDP Ancillary Data Sets

Product	ESDTs	File Description
Reference Orbit Imagery	MIRFOI	ROI
Angular Signature Thresholds Dataset	MIAST	Ang. Sig. Thresholds
Terrestrial Atmosphere and Surface Climatology Dataset	MIANTASC	TASC
Albedo Azimuth Modelling Dataset	MIANAZM	AZM
Ancillary Land Biome Dataset	MIANLDBM	Land Biome Dataset
SMART Dataset	MIANSMT	SMART
Aerosol Climatology Product	MIANACP	ACP
Tropical Ocean Atmosphere Correction Dataset	MIANTOAC	TOAC

2.3 MISR SDP: EXTERNAL DATA SET DEPENDENCIES

MISR SDP at the LaRC DAAC requires the ancillary data sets described in section 2.2.2 together with the external data sets listed in Table 2-3 below.

Table 2-3: MISR SDP External Data Set Dependencies

External Data Sets Required for MISR SDP
DAO Atmospheric Data
MODIS Column Water Vapor Amount
MODIS Snow and Ice Cover
NSIDC Near real-time Ice and Snow Extent
NSCAT Surface Wind Speed
MODIS Cloud Top Height
MODIS Cloud Phase
MODIS Cloud Mask
SAGE Stratosphere Aerosol Optical Depth
Earth-Sun Ephemeris
Spacecraft Ancillary Data

If for some reason one of the external data sets above is unavailable to MISR SDP at the LaRC DAAC, then the ancillary data from the MISR TASC file will be used. The important geophysical parameters extracted from the data sets above are listed in Table 2-4 below.

Table 2-4: MISR SDP External Geophysical Parameter Dependencies

Geophysical Parameter	Data Source
Cloud Phase (Liquid/Ice)	MODIS Cloud Phase Properties
	DAO cloud phase or temperature profile or geopotential height
	MISR SCF TASC dataset
Cloud Top Height	MODIS Cloud Mask
High Cloud Top Altitude	MISR SCF TASC dataset
Stratosphere Aerosol Optical Depth	SAGE III
Surface Wind Speed	DAO surface wind speed
	MISR SCF TASC dataset
Surface Pressure	DAO surface pressure
	MISR SCF TASC dataset
Relative Humidity	MODIS temperature/moisture profiles or precipitable water
	DAO relative humidity vs. pressure or geopotential height
	MISR SCF TASC dataset (relative humidity in boundary layer)
Snow/Ice Cover	MODIS L2 daily snow/ice
	NSIDC weekly snow/ice
	MISR SCF TASC dataset
Ozone Optical Depth	MODIS total column ozone
	DAO ozone profile vs. pressure
	MISR SCF TASC dataset (ozone column abundance)
Tropopause Height	DAO tropopause pressure or geopotential height array
	MISR SCF TASC dataset

2.4 MISR SDP: STANDARD SCIENCE DATA PRODUCTS

The end result of MISR SDP at the LaRC DAAC are the MISR project standard science data products listed in Table [2-5] below. This document describes the product versions indicated in the final column.

 = Not yet implemented

Table 2-5: MISR Project Standard Science Data Products

Product	ESDTs	File Description	File Type	Applicable Product Version
Level 1A Reformatted Annotated Product	MIL1A	L1A CCD Science	HDF-EOS Swath	F02_0016, F02_0017, F02_0018, F02_0019, F02_0020
		L1A Browse Removed Sep, 2001		
	MI1AENG1	L1A Engineering	HDF-EOS Swath	F01_0006, F01_0007
	MI1ANAV	L1A Navigation	HDF-EOS Swath	0006, 0007
	MI1AMOT	L1A Motor	HDF-EOS Swath	F01_0005, F01_0006
	MI1AC	L1A CCD Calibration	HDF-EOS Swath	F01_0006, F01_0007
	MI1AOBC	L1A OBC data	HDF-EOS Swath	F01_0005, F01_0006
Level 1B1 Radiometric Product	MI1B1	L1B1 Global Mode	HDF-EOS Swath	F02_0016, F02_0017, F02_0018 F02_0019, F02_0020
	MI1B1LM	L1B1 Local Mode	HDF-EOS Swath	F02_0016, F02_0017, F02_0018 F02_0019, F02_0020

Table 2-5: MISR Project Standard Science Data Products

Product	ESDTs	File Description	File Type	Applicable Product Version
Level 1B2 Georectified Radiance Product	MI1B2T	L1B2 Terrain	HDF-EOS Stacked-Block Grid	F02_0016, F02_0017, F02_0018 F02_0019, F02_0020
	MI1B2E	L1B2 Ellipsoid	HDF-EOS Stacked-Block Grid	F02_0016, F02_0017, F02_0018 F02_0019, F02_0020
	MISBR	PGE 1 Ellipsoid Browse	JPEG	F02_0016, F02_0017, F02_0018 F02_0019, F02_0020
	MIRCCM	RCCM	HDF-EOS Stacked-Block Grid	F02_0016, F02_0017, F02_0018 F02_0019, F02_0020
	MIB2LMT	L1B2 Terr. Local Mode	HDF-EOS Stacked-Block Grid	F02_0019 F02_0020
	MIB2LME	L1B2 Ellip. Local Mode	HDF-EOS Stacked-Block Grid	F02_0019 F02_0020
	MIB2GEOP	Geometric Parameters	HDF-EOS Stacked-Block Grid	F03_0010, F03_0011 F03_0012
	MIANRCCH	RCCM histogram updates	HDF-EOS Stacked-Block Grid	F02_0016, F02_0017, F02_0018 F02_0019, F02_0020



Table 2-5: MISR Project Standard Science Data Products

Product	ESDTs	File Description	File Type	Applicable Product Version
Level 2 TOA/Cloud Product	MIL2TCST	L2TC Stereo	HDF-EOS Stacked-Block Grid	F06_0009
	MIL2TCAL	L2TC Albedo	HDF-EOS Stacked-Block Grid	F03_0005
	MIL2TCCL	L2TC Classifiers	HDF-EOS Stacked-Block Grid	F03_0003
	MIASH	Ang. Sig. Histogram	HDF-EOS Stacked-Block Grid	
	MISBR	L2TC Browse	HDF-EOS Stacked-Block Grid	
Level 2 Aerosol/Surface Product	MIL2ASOS	L2AS Ocean Surface	HDF-EOS Stacked-Block Grid	
	MIL2ASLS	L2AS Land Surface	HDF-EOS Stacked-Block Grid	F04_0013
	MIL2ASAE	L2AS Aerosol	HDF-EOS Stacked-Block Grid	F06_0013
	MISBR	L2AS Browse	HDF-EOS Stacked-Block Grid	
Level 3 Component Global Georectified Product	MIL3MRD MIL3QRD MIL3YRD	L3 Radiance	HDF-EOS Geographic Grid	F02_0007, F02_0009
Level 3 Component Global Aerosol Product	MIL3MAE MIL3QAE MIL3YAE	L3 Aerosol	HDF-EOS Geographic Grid	F02_0006, F02_0008
Level 3 Component Global Land/Surface Product	MIL3MLS MIL3QLS MIL3YLS	L3 Land/Surface	HDF-EOS Geographic Grid	F01_0006, F02_0008

Table 2-5: MISR Project Standard Science Data Products

Product	ESDTs	File Description	File Type	Applicable Product Version
Ancillary Products		Radiometric Product	NCSA-Supplied HDF Objects	N/A
		Climatology Product	NCSA-Supplied HDF Objects	N/A

3.0 MISR PRODUCTS: FILE FORMAT OVERVIEW

3.1 HDF AND HDF-EOS FILE STRUCTURES

This section describes the specifications for the MISR products that will be archived at the NASA LaRC DAAC. The MISR files (with one exception as noted below) are implemented in the Hierarchical Data Format (HDF). Most, but not all, of the MISR standard data products are in one of two file formats: HDF-EOS Swath or HDF-EOS Grid, which are extensions of the original HDF as developed by the National Center for Supercomputing Applications (NCSA). The HDF-EOS file interfaces were developed by the EOS Core System (ECS) developers. Standard NCSA HDF terminology, as well as the EOS developed interface terminology, are used in this document when describing these files.

The HDF-EOS data products used by MISR (Swath and Grid) have been defined within the HDF framework and are supported by special application programming interfaces (API) which aid the data producer and user in writing to and reading from these files. These APIs allow data products to be created and manipulated in ways appropriate to each datatype, without regard to the actual HDF objects and conventions underlying them.

The file specifications given here are in terms of the logical implementation of MISR standard data products in HDF and do not describe the actual physical layout of the files, although there is an attempt to show what the physical layout of a file looks like. The same data object may exist in different relative locations for two iterations of a product file. The locations are determined by HDF on a file-by-file basis and are not important to actually accessing the data using API calls.

3.2 MISR PRODUCTS: DATA FORMATS

Of all of the MISR standard science data products, only the MISR Ancillary Radiometric Product and Aerosol Climatology Product files use standard NCSA-supplied HDF file structures. The MISR Level 1A Reformatted Annotated Product and Level 1B1 Radiometric Product data use the HDF-EOS Swath file type. The HDF-EOS Swath interface is designed to support time-ordered data, such as satellite swaths with time-ordered series of scanlines or time-ordered series of profiles.

The MISR Level 3 products are HDF-EOS Grid files, using a geographic projection.

The remaining MISR products are HDF-EOS Grid files. The HDF-EOS Grid interface was originally intended for storing Level 3 and above products, that is, products which have been “gridded” to a single Earth-based map projection. The storage of map projection parameters are part of the format, and routines to access the data in Grid format by geolocation are supplied in the Grid API. MISR stores “swath-like” products at Level 1B2 and Level 2 in a space-based map projection. In particular, MISR SDP breaks up L1B2 and L2 swaths into equal-sized blocks. The term “block” refers to a pre-defined, static, fixed-size, rectangular SOM region on the Earth which a) is wide enough to contain the horizontal overlap of all 9 MISR camera views at low latitudes, b) is the

geographic unit over which MISR SDP is attempted and c) is the standard unit of MISR data access. The block construct enables the co-registration of 9 different images with a minimal waste of space and processing effort. Changes were made to the HDF-EOS Grid implementation, specific to MISR SDP needs, to handle these blocks as an additional dimension to a Grid dataset. This implementation is referred to as the “Stacked-block” Grid implementation. The user is referred to Appendix [A] where complete details surrounding Stacked-block grid data access may be found.

In brief, the solution to meet MISR’s needs for its Level 1B2 and Level 2 data products is to “stack” all of the blocks of an orbit into a single dataset, where the “third” dimension for the dataset becomes the block number (Figure 3-1). Groups of parameters of a product can be stored in these “stacked-block” Grid data structures, but each parameter in the dataset must have the same x and y dimensions (i.e., same resolution). Within a Grid dataset, parameters can also be grouped into what HDF-EOS calls a “field”, but each parameter in the field must be of the same data type (e.g., 2-byte integer).

Figure 3-1 MISR SOM Representation in HDF-EOS.

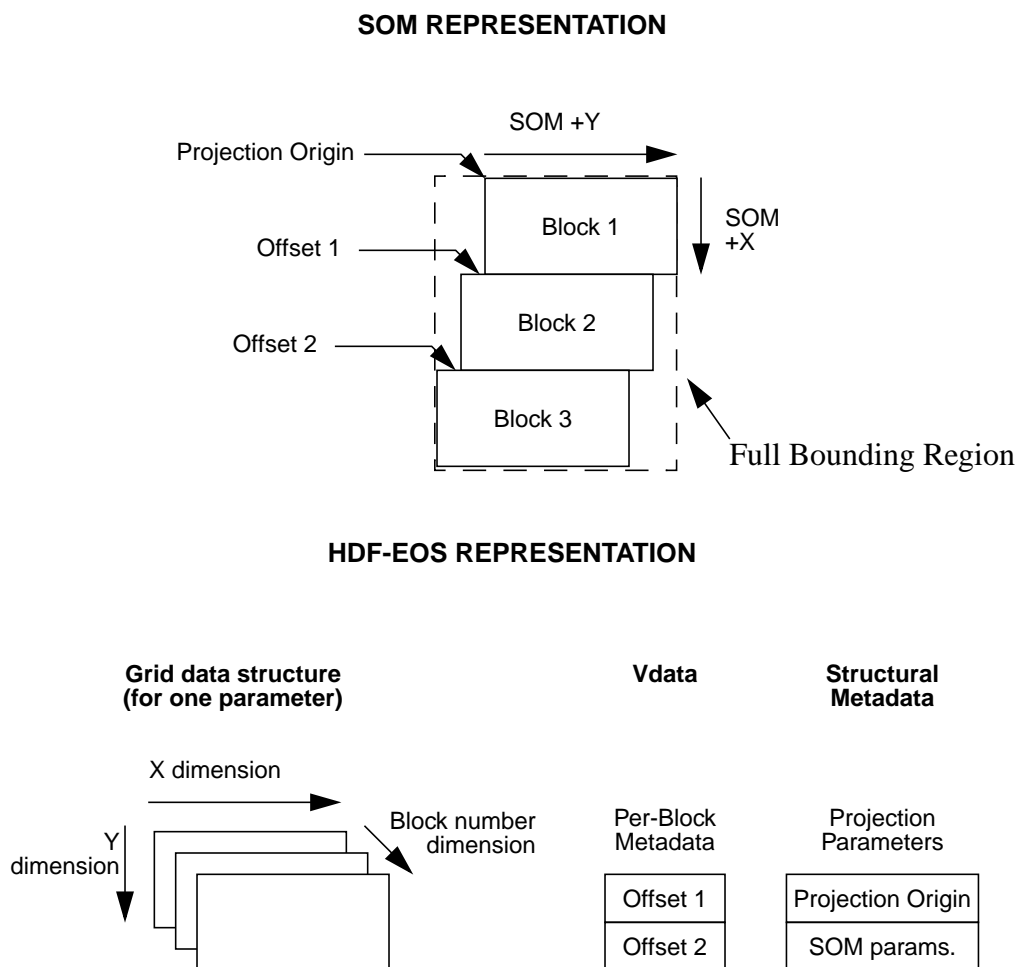

180 blocks are required to cover the seasonal sun-lit ground under a single path. Each of the 233 WRS Terra orbit paths has a separate set of 180 MISR blocks defined to span it. The MISR Ancillary Geographic Products is the reference dataset containing full lat/lon information about block locations. Refer to section [9.4] for further AGP information. Each block could have been its own grid in a separate file, but that model did not meet MISR SDP IO constraints. Attempting to make one rectangular grid spanning the entire swath range was size-prohibitive. At product design time, HDF tiling and compression wouldn't support that large of a region. The compromise solution was to store only the projection origin for Block 1 and save in a separate dataset the horizontal offset of each block beneath Block 1. This offset is specified in integer pixels from the upper left hand corner of Block 1. The storing of these offsets is taken care of by a Grid library routine (GDbkSOMoffset). Offsets may be retrieved with the same routine. With the projection origin information, the projection information and the block offset information, transformations between (block/line/sample \leftrightarrow SOM X/Y \leftrightarrow lat/lon) are possible. HDF-EOS and the accompanying

GCTP map projection library do most of the work automatically. The user is again referred to Appendix [A].

3.3 MISR PRODUCTS: METADATA FORMATS

No matter what kind of product file is created, metadata must be attached to it for descriptive purposes within the ECS environment. All of the files have an accompanying simple ASCII file containing metadata which is produced at the same time that the file is produced. These attached ASCII files contain what is called the Core, or Inventory, Metadata, which is the second type of metadata described below. For MISR standard data product files that use only native HDF objects, Inventory Metadata is the only type of metadata that is produced for the product.

For MISR HDF-EOS Swath and Grid file types six classes of metadata may be used: 1) Structural Metadata, 2) Core Metadata, 3) Product Metadata, 4) File Metadata, 5) Grid/Swath Metadata and 6) Per-block Metadata (for Grid files only). The first three classes of metadata are recognized by ECS and can be searched in the ECS Data Server database. The last three classes were invented by MISR and contain values required by MISR processing. Attempts to provide convenient data access often clash with requirements to meet programmatic standards. Since metadata is usually small in size, the MISR team handled such clashes by including redundant information in places where it was warranted.

3.3.1 Structural Metadata

Structural Metadata are attached to files automatically by HDF-EOS software when writing out HDF-EOS files. These metadata describe the structure of the file in terms of its dimensions, Swath or Grid characteristics, projection (for Grid only), and data fields. These metadata are used by HDF-EOS software to recognize file structures when reading back the data.

3.3.2 Core Metadata

Core, or Inventory, Metadata provide granule level information used for ingesting, cataloging, and searching the data product. These metadata are attached to HDF-EOS files by Toolkit metadata calls. A Metadata Configuration File (MCF), which describes Inventory Metadata attributes, is used when creating an HDF file using the Toolkit. An additional ASCII Inventory Metadata file is produced at file-time creation which provides granule level information. This ASCII file has the same name as the HDF or HDF-EOS output file with the extension of .met. These files are not described in this document.

3.3.3 Product Metadata

Product, or Archive, Metadata provide granule level information that is not used for search purposes, but which are important to be kept with the HDF-EOS file. These metadata are also attached by Toolkit metadata calls during product generation and their attributes are also contained in the MCF file. MISR processing does not currently use Archive Metadata, preferring to

create and use the next three types of metadata described below.

3.3.4 File Metadata

File Metadata, when used by MISR processing, contain MISR-specific information that is common to a whole file. These metadata are stored as global attributes that are attached to the standard NCSA-supplied HDF Scientific Dataset (SD) object. (We found it necessary to use SD object global attributes since the HDF-EOS Grid and Swath APIs do not provide a means of storing global data relevant to an entire file as opposed to a single Swath or Grid data set.) These metadata are used to process a file, but they are not intended to be used for search purposes. MISR is currently using this class of metadata to store such things as additional projection information and product statistics. If a file contains only one Grid or Swath dataset, and Grid/Swath-Metadata (section 3.3.5 below) are attached at that level, File Metadata may not be included in the file. The values for a particular attribute must all be of the same type.

3.3.5 Per-grid/Per-swath Metadata

Grid and Swath Metadata are internal to HDF-EOS files and are used to provide MISR-specific information unique to an individual Grid or Swath dataset in the file. An example of such metadata is the resolution of the data in a Grid or Swath dataset. In the case of Swath files, these metadata are the global attributes of a Swath dataset, while in the case of Grid files these are Grid attributes attached using HDF-EOS Grid application calls. The values for a particular attribute must all be the same type.

3.3.6 Per-block Metadata

The Per-block Metadata are internal to the file and are used to provide MISR-specific information unique to an individual block of a Grid dataset. This class of metadata is used only in Grid files. Since the HDF-EOS Grid API does not contain structures for dealing with MISR blocks, these metadata are stored using standard NCSA-supplied HDF Vdata tables within the file. A wrapper was written around the native HDF Vdata interface for reading and writing Per-block Metadata. Because native HDF expects a file id returned from Hopen, the file id returned from GDopen cannot be used when calling native HDF routines. Consequently, an HDF-EOS function, called EHidinfo, has been provided for translating grid file ids to native file ids. The native file id is then used in the Vdata calls. The attributes stored in Per-block Metadata include per-block coordinates, such as L1B2 transform information, and statistics.

3.4 MISR PRODUCTS: QUALITY ASSURANCE FORMATS

To characterize the quality of MISR standard science data products four types of Quality Assurance (QA) structures have been developed by MISR project scientists and they are related naturally to MISR instrument swaths, blocks, lines and pixels. Typical QA content consists of a collection of statistics that may be indexed over some dimension (e.g., block within a swath). The most suitable HDF type for this purpose is a standard NCSA-supplied HDF Vdata. Vdata's are

collections of one-dimensional fixed-length records, where each record is composed of one or more fixed-length array fields. Vdata records are identical in structure; however, the content, or data, may vary from one record to the next. The number of records in a Vdata is not fixed, as records can be appended to a Vdata. The limitation of the Vdata structure is its restriction to a single dimension, i.e., records cannot be indexed by two or more dimensions. MISR QA Vdatas are organized within standard NCSA-supplied HDF Vgroups, container classes that collect related objects together. Using VGroups to organize the Vdatas helps define a file logically and also makes viewing MISR QA easier.

3.4.1 QA Fields

As alluded to in the above paragraph, MISR QA is organized around MISR instrument swaths, blocks, lines, and pixels. The QA statistics are generally organized within the following four fields of a Vdata.

Per-swath Field - Single value statistic (integer or floating point) relevant to an entire MISR swath of a data product. There might be on the order of 100 Per-swath QA Fields defined in a given QA file.

Per-block Field - Single value statistic (integer or floating point) relevant to a particular MISR block. There might be on the order of 100 Per-block QA Fields defined in a given QA file. There are 180 blocks in a MISR swath for each of the 4 bands of each of the nine MISR cameras. All Per-block QA Fields relating to a particular block should be indexed by that block number, but should also be easily displayed as a single statistic down the length of the swath. The Per-block QA Field is primarily used with HDF-EOS Grid products.

Per-line Field - Single value statistic (integer or floating point) relevant to a particular line in a swath. There might be on the order of 100 per-line fields defined in a given QA file. There are up to 72,000 in a MISR swath for each band of each camera. All Per-line QA Fields relating to a particular line should be indexed by that line number, but should also be easily displayed as a single statistic down the length of the swath. The Per-line QA Field is primarily used with HDF-EOS Swath products.

Per-pixel Field - Single value statistic (integer or floating point) relevant to a particular pixel in a swath. There are 1520 pixels in a line. All Per-pixel QA Fields relating to a particular pixel should be indexed by that pixel number. The Per-pixel QA Field is primarily used with HDF-EOS Swath products.

MISR standard data products also incorporate a few unique QA structures in addition to the above four. These additional QA structures are special in that they have more than one dimension which are not predefined in size. An example is the Grid Cell structure needed by L1B2:

Per-grid Cell Field - Single value statistic (integer or floating point) relevant to a particular



L1B2 grid cell in a particular block, where the number of grid cells per block ranges from 2 to 6. All Per-grid Cell Fields are indexed by block and then by grid cell.

3.4.2 Standard QA Vdatas and VGroups

All Vgroups and Vdatas are identified by a name and class. Since HDF identifies objects by unique reference and tag numbers, the class and name do not have to be unique. However, HDF functions that search for names/classes, as opposed to reference numbers and tags, return the first occurrence found. A typical convention, which MISR QA adheres to, is to have unique names and classes specific to a type of Vdata. All Vdatas that share a class name have identical record structures.

A black box set of routines for performing all MISR QA operations would be useful. However, this is not possible because every MISR data product has its own unique set of QA statistics. The best that we can achieve is to enforce a set of rules for QA file formats and provide a library of code that wraps low level HDF calls for accessing the QA Vdatas. The rules of QA file format are as follows:

- All QA types will have a Vgroup to which all related Vdatas and Vgroups will be attached.
- All QA data are stored in Vdatas, where Vdata attributes may be used where appropriate.
- All Vdatas will belong to a single Vgroup; lone Vdatas and membership to multiple Vgroups are not allowed.
- A naming convention will be established for Vdata/Vgroup names and classes.
- The Per-swath, Per-block, Per-line, and Per-pixel QA types will have predefined names located in a .h file.
- One exception to the rule: QA metadata for describing the origin of the data (time of collection, orbit number, etc.) don't really belong in any particular Vgroup or Vdata; therefore, they will be implemented as global SD attributes.

The basic organization of the four standard QA types is illustrated in Figure 3-2 below. The swath QA is stored in a Vdata for consistency. There will only be one record in the Vdata because MISR products are created on a per swath basis. The block, line, and pixel level QA use

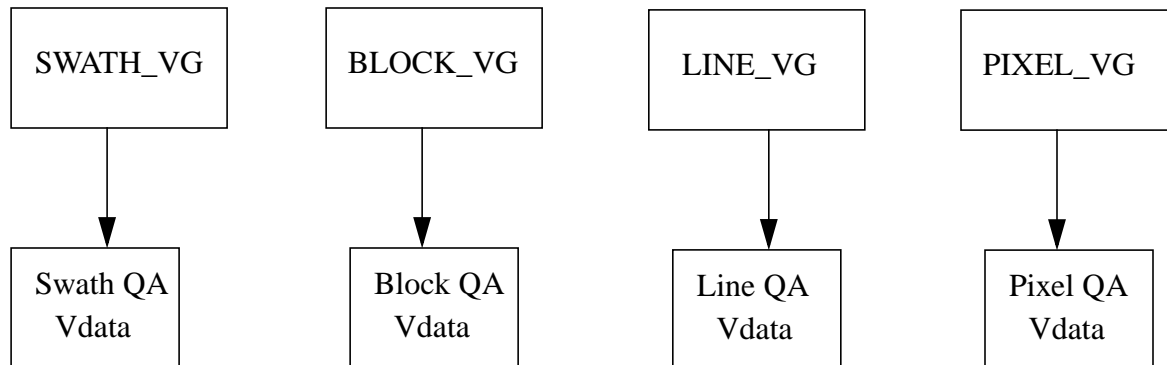

Figure 3-2 MISR QA standard Vdata and Vgroup structures.

the block, line, and pixel dimension, respectively, as the record dimension. It is probably most common for these records to be contiguous; however, to allow a more sparse storage scheme (i.e., maybe only some blocks have QA) one of the fields in the Per-block record indicates the MISR block number and one of the fields in the Per-line record indicates the line number.

We have adopted the convention of using unique names for Vdatas and Vgroups and unique classes to describe the type of QA. For clarity these conventions, as well as some additional constraints from MISR SDP, are enumerated below:

- All type of names (Vgroup, Vdata, attribute, field, etc.) should contain no spaces. Underscores are acceptable. To conserve space MISR capitalizes the first letter of each word, e.g., “SwathQaRed1x1”.
- All Vgroup/Vdata names within a single MISR file are unique.
- All classes are prefixed by the name of the MISR product, guaranteeing uniqueness across product types. For example, the L1B2 terrain projected radiance QA file will prefix all classes with the “Terrain” string.
- Within a single file Vdata classes are common for identical record types, but unique for each type of record. For example, some level L1B1 QA are separated by band and average mode, but information for each is the same. All of the individual Vdatas (e.g., “LineQaRed1x1”, “LineQaGreen4x4”) share one class (e.g., “B1GlobalModeLineQaBandAvgMode”). However, a global line QA structure (e.g., “LineQaGlobal”) has a different class (“B1GlobalModeLineQaGlobal”).
- Vgroup classes can be conveniently named the same as the Vgroup name with the product type prepended. Unlike Vdatas, there aren’t multiple instances of Vgroups that share a common class.

3.4.3 Special QA Vdatas and VGroups

There are no hard rules for adding custom MISR QA structures; whatever is logical and fits within

the general QA rules is the best approach. As an example, the L1B2 Terrain processing operates on units called Grid Cells. A Grid Cell is a subregion of a block. The number of grid cells in a block is not fixed, nor known, until the block is actually processed. This prevents us from just adding grid cell fields to the block QA and making each field n-dimensional with n being the number of grid cells in that block. Remember that Vdata records are fixed in length. We could determine the maximum value of n and use it to fix a Vdata record length; however, this would waste a lot of space in the QA file. Therefore, Grid Cell QA must be stored in a separate Vdata. It is desirable to index a Grid Cell by the block to which it belongs, as well its grid cell index. If we create a single Vdata for the Grid Cell QA, then one of the fields would map each record to the appropriate block number. Another alternative is to create a Vdata for each block of Grid Cells. This latter approach proves to be a better solution because Grid Cells are usually examined in the context of a block.

An example of MISR QA that incorporates the standard and special Grid Cell QA types is illustrated in Figure 3-3. The L1B2 product tracks swath level QA statistics for each band, where each band has a particular averaging mode associated with it. In this instance we create a distinct Vdata for each band with the averaging mode in the name. So, if the Red band is in the 1x1 averaging mode, we have the Vdata "Red 1x1 QA." These Vdatas are attached to the swath Vgroup. The Grid Cell Vgroup is placed under the Block Vgroup to associate them logically as discussed above. This implies that someone wouldn't be interested in looking at Grid Cell QA without first examining block QA. Because there are multiple Grid Cell Vdatas, we append the block number to the base name (e.g, "Grid Cell QA 1").

The four standard metadata types - swath, block, pixel, and line, have the following rules for all products:

- Per-swath Vdata always consists of a single record;
- Per-block Vdata maps block number to record number; the convention used in the product data files is that record 0 corresponds to Block 1, record 1 corresponds to Block 2, etc., even though we only process ~140 of the 180 blocks per swath; required fields are "BlockNumber" and "ValidRecord;"
- Per-line Vdata maps line number to record number; the convention used in the product data files is that record 0 corresponds to Line 0, etc.; required fields are "LineNumber" and "ValidRecord;"
- Per-pixel Vdata maps pixel number to record number; the convention used in the product data files is that record 0 corresponds to Pixel 0, etc.; required fields are "PixelNumber" and "ValidRecord."

Figure 3-3 MISR QA special Grid Cell Vdata structures.

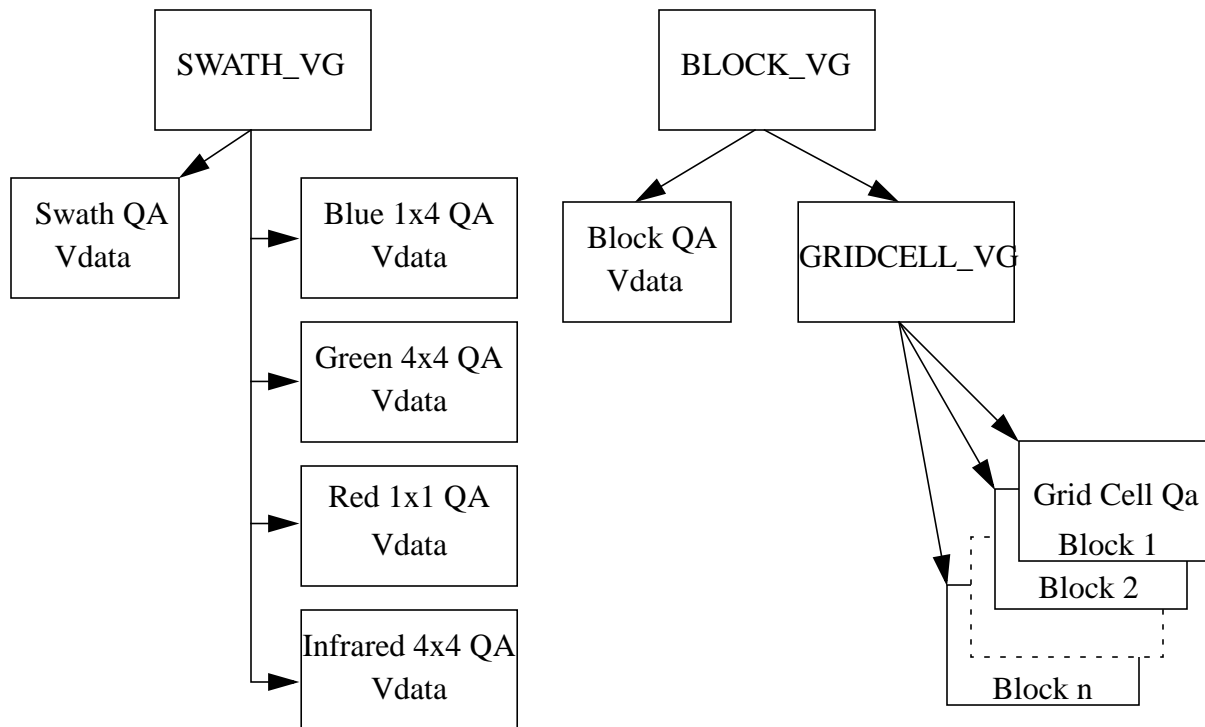

4.0 MISR LEVEL 1A REFORMATTED ANNOTATED PRODUCT

4.1 MISR LEVEL 1A PRODUCT GRANULE NAMES

MISR Level 1A Reformatted Annotated Products are composed of the six different file granules listed below:

Table 4-1: MISR Level 1A File Granule Names.

MISR LEVEL 1A FILE GRANULE NAME	ESDT Name	Section
MISR_AM1_FM_SCI_Pmmm_Onnnnnn_cc_Fff_vvvv.hdf	MIL1A	4.5
MISR_AM1_FM_CAL_Pmmm_Onnnnnn_cc_Fff_vvvv.hdf	MI1AC	4.6
MISR_AM1_FM_MTR_CL_Pmmm_Onnnnnn_Fff_vvvv.hdf	MI1AMOT	4.7
MISR_AM1_FM_NAV_GM_Pmmm_Onnnnnn_Fff_vvvv.hdf	MI1ANAV	4.8
MISR_AM1_FM_ENG_GM_Pmmm_Onnnnnn_Fff_vvvv.hdf	MI1AENG1	4.9
MISR_AM1_FM_OBC_CL_Pmmm_Onnnnnn_Fff_vvvv.hdf	MI1AOBC	4.10

4.2 MISR LEVEL 1A PRODUCT GRANULE BRIEF DESCRIPTIONS

4.2.1 MISR LEVEL 1A MIL1A CCD Science Instrument Data

MISR Level 1A (MIL1A) CCD Science Instrument Data are the primary archive of the MISR instrument. The MISR CCD Science Instrument Data acquired from all nine of the MISR cameras for each of the four bands represent the raw MISR input data staged for MISR Science Instrument Data processing. There are nine file granules of this type, one corresponding to each of the nine MISR cameras. Each file granule contains four entire swaths of data, one swath for each of the four MISR bands associated with each MISR camera.

There are three functional processing steps to transform the raw Level 0 data into the Level 1A output: reversal of the square-root encoding performed on the instrument data, byte-alignment, and reformatting of CCD line array data. The reversal of the square-root encoding converts the 12-bit data fields extracted from the CCD Science Instrument Data packets into 14-bit CCD DN data values. The L1A CCD Science Instrument Data include both radiance data and Image Data Quality Indicator (IDQI) parameters. The IDQI values are packed in the least significant 2 bits of the DN data. Therefore, each CCD Science Instrument Datum at the pixel level is 16-bits: 14 bits for the radiance value and 2-bits for the IDQI value. Verifications of packet sequencing, formats and sizes are also executed and reported. The Level 1A output product is time-ordered, band-separated and error-checked.

ECS metadata are generated and incorporated into the product, as well as placed into an associ-

ated Core, or Product, Metadata file. A QA statistics file is no longer generated for this product.

Processing of the raw CCD Science Instrument Data no longer includes generation of the Level 1 browse product. The Level 1 browse product was output as a JPEG file in HDF RIS8 format. The browse product was based on the MISR red band with a 1x1 (275 m by 275 m) sampling that is pixel-averaged uniformly throughout the entire swath to a resolution of 4.4 km.

4.2.2 MISR LEVEL 1A MI1AC CCD Calibration Data

MISR Level 1A (MI1AC) CCD Calibration Data are acquired as part of an on-orbit calibration experiment. These data are distinct from CCD Science Instrument Data and are identified with nine different APID (packet identification number) codes. The MISR L1A CCD Calibration Data include both radiance data and Image Data Quality Indicator (IDQI) parameters. The IDQI values are packed in the least significant 2 bits of the DN data. Hence, the per-pixel format of these data are identical to the CCD Science Instrument Data.

4.2.3 MISR LEVEL 1A MI1AMOT Motor Data

MISR Level 1A (MI1AMOT) Motor Data are acquired as part of an on-orbit calibration experiment. These data consist of measurements of the MISR instrument calibration panel motor currents. These data also include packet data for motor ID, motor current sampling frequency, and motor temperature.

4.2.4 MISR LEVEL 1A MI1ANAV Navigation Data

MISR Level 1A (MI1ANAV) Navigation Data include all spacecraft position, velocity, attitude and attitude rate data incorporated into MISR Level 1A Engineering Data packets. These data are read from the Command and Telemetry Bus during the period of one EOS-TERRA orbit.

4.2.5 MISR LEVEL 1A MI1AENG Engineering Data

MISR Level 1A (MI1AENG1) Engineering Data provide all of the data needed to describe the state of the instrument for Level 1 processing and analysis at a later date. These data are composed primarily of temperatures, voltages and currents of each camera, the optical bench, calibration-diodes, and system electronics. Verification and reporting flags for latches and limit-switches on the cover/goniometer and the calibration diffuser panels are also incorporated into these data.

4.2.6 MISR LEVEL 1A MI1AOBC On-Board Calibration Data

MISR Level 1A (MI1AOBC) On-board Calibration Data provide the radiometry from PIN and HQE diodes and goniometer mechanism readings collected during calibration mode operations near the north and south poles and over the darkside of the Earth (or during science mode operations over the sunlit side of the Earth). The diode radiometry acquired during north and south pole

calibration sequences will be used to determine brightness and reflective characteristics of a MISR diffuser panel as observed by each of the nine MISR cameras.

4.3 MISR LEVEL 1A PRODUCT GRANULE DATA SETS

The MISR Level 1A Standard Science Data Product is composed of 6 separate ESDTs, each with one physical file format, as shown in Table 4-2. Each physical file is in the HDF-EOS Swath format and each contains one or more HDF-EOS Swath datasets (Table 4-2)..

Table 4-2: MISR Level 1A Reformatted Annotated Product Files and Swath Datasets

ESDT Shortname	Local Granule ID ^a	Swath Dataset Name
MIL1A	MISR_AM1_FM_SCI_Pmmm_Onnnnnn_cc_Fff_vvvv.hdf	blue_band_1x1 blue_anc_1x1 green_band_1x1 green_anc_1x1 red_band_1x1 red_anc_1x1 nir_band_1x1 nir_anc_1x1 blue_band_1x4 blue_anc_1x4 green_band_1x4 green_anc_1x4 red_band_1x4 red_anc_1x4 nir_band_1x4 nir_anc_1x4 blue_band_2x2 blue_anc_2x2 green_band_2x2 green_anc_2x2 red_band_2x2 red_anc_2x2 nir_band_2x2 nir_anc_2x2 blue_band_4x4 blue_anc_4x4 green_band_4x4 green_anc_4x4 red_band_4x4 red_anc_4x4 nir_band_4x4 nir_anc_4x4 spurious_pkts

Table 4-2: MISR Level 1A Reformatted Annotated Product Files and Swath Datasets

ESDT Shortname	Local Granule ID ^a	Swath Dataset Name
MI1AC	MISR_AM1_FM_CAL_Pmmm_Onnnnnn_cc_Fff_vvvv.hdf	blue_band_1x1 blue_anc_1x1 green_band_1x1 green_anc_1x1 red_band_1x1 red_anc_1x1 nir_band_1x1 nir_anc_1x1 blue_band_1x4 blue_anc_1x4 green_band_1x4 green_anc_1x4 red_band_1x4 red_anc_1x4 nir_band_1x4 nir_anc_1x4 blue_band_2x2 blue_anc_2x2 green_band_2x2 green_anc_2x2 red_band_2x2 red_anc_2x2 nir_band_2x2 nir_anc_2x2 blue_band_4x4 blue_anc_4x4 green_band_4x4 green_anc_4x4 red_band_4x4 red_anc_4x4 nir_band_4x4 nir_anc_4x4
MI1AMOT	MISR_AM1_FM_MTR_CL_Pmmm_Onnnnnn_Fff_vvvv.hdf	MTRSwath
MI1AENG1	MISR_AM1_FM_ENG_GM_Pmmm_Onnnnnn_Fff_vvvv.hdf	EngSwath
MI1ANAV	MISR_AM1_FM_NAV_GM_Pmmm_Onnnnnn_Fff_vvvv.hdf	NavSwath
MI1AOBC	MISR_AM1_FM_OBC_CL_Pmmm_Onnnnnn_Fff_vvvv.hdf	OBCSwath

a. Where Pmmm corresponds to the orbit path number, Onnnnnn is the absolute orbit number, cc is the camera identifier, and Fff is the file format version and vvvv is the file version number.

4.4 MISR LEVEL 1A PRODUCT SHARED SWATH DESCRIPTORS

Dimension	Description	Valid Values
DownTrack	Unlimited, number of lines acquired during the collection of MISR CCD science data	0 -
CrossTrack	Number of CCD DN's acquired	380 for 4x4 averaging 760 for 2x2 averaging 1520 for 1x1, 1x4 averaging

For the nominal Global Mode called “Super Stereo”, the following table relates the spatial resolution to camera and band.

Table 4-3: Spatial Resolution Distribution for Global mode

Grid	DF	CF	BF	AF	AN	AA	BA	CA	DA
NIRBand	1.1 km x 1.1 km	1.1 km x 1.1 km	1.1 km x 1.1 km	1.1 km x 1.1 km	275 m x 275 m	1.1 km x 1.1 km	1.1 km x 1.1 km	1.1 km x 1.1 km	1.1 km x 1.1 km
RedBand	275 m x 275 m	275 m x 275 m	275 m x 275 m	275 m x 275 m	275 m x 275 m	275 m x 275 m	275 m x 275 m	275 m x 275 m	275 m x 275 m
BlueBand	1.1 km x 1.1 km	1.1 km x 1.1 km	1.1 km x 1.1 km	1.1 km x 1.1 km	275 m x 275 m	1.1 km x 1.1 km	1.1 km x 1.1 km	1.1 km x 1.1 km	1.1 km x 1.1 km
GreenBand	1.1 km x 1.1 km	1.1 km x 1.1 km	1.1 km x 1.1 km	1.1 km x 1.1 km	275 m x 275 m	1.1 km x 1.1 km	1.1 km x 1.1 km	1.1 km x 1.1 km	1.1 km x 1.1 km

For Local Mode, the following table relates the spatial resolution to camera and band.

Table 4-4: Spatial Resolution Distribution for Local mode

Grid	DF	CF	BF	AF	AN	AA	BA	CA	DA
NIRBand	275 m x 275 m	275 m x 275 m	275 m x 275 m	275 m x 275 m	275 m x 275 m	275 m x 275 m	275 m x 275 m	275 m x 275 m	275 m x 275 m
RedBand	275 m x 275 m	275 m x 275 m	275 m x 275 m	275 m x 275 m	275 m x 275 m	275 m x 275 m	275 m x 275 m	275 m x 275 m	275 m x 275 m
BlueBand	275 m x 275 m	275 m x 275 m	275 m x 275 m	275 m x 275 m	275 m x 275 m	275 m x 275 m	275 m x 275 m	275 m x 275 m	275 m x 275 m
GreenBand	275 m x 275 m	275 m x 275 m	275 m x 275 m	275 m x 275 m	275 m x 275 m	275 m x 275 m	275 m x 275 m	275 m x 275 m	275 m x 275 m

4.5 MISR LEVEL 1A MIL1A CCD SCIENCE INSTRUMENT DATA

4.5.1 File Metadata Description

None.

4.5.2 Per-swath Metadata Description

Table 4-5: CCD Science Per-Swath Metadata.

Swath Metadata	Definition	Data Type	Valid Values
NumLines	not used	uint32	0
NumSamples	not used	uint32	0
NumSatSamples	not used	uint32	0
NumSatLines	not used	uint32	0
NumLinesWithSatPixels	not used	uint32	0
NumLinesThreshFail	not used	uint32	0

4.5.3 Per-block Metadata Description

N/A

4.5.4 Per-line Metadata Description

The CCD Science Data file uses primarily Per-Line Metadata (Table 4-6). Per-Line Metadata are stored in the Time Tags SDS linked to the DNs SDS by sharing the same X-Dim. For instance, the red band DNs are in the swath red_band_1x1.DN. The corresponding Per-Line Metadata is in the swath red_anc_1x1.Time Tags. .

Table 4-6: CCD Science Per-Line Metadata.

PerLine Metadata	Definition	Data Type	Valid Range
time_days	Time tag(0) -first 16 bits of 64 bit time tag field representing days	FLOAT32	0 - 65535
time_msec1	Time tag(1) - second 16 bits of 64 bit time tag field representing milliseconds	FLOAT32	0 - 65535
time_msec2	Time tag(2) - third 16 bits of 64 bit time tag field representing milliseconds	FLOAT32	0 - 65535
time_micro	Time tag(3) - fourth 16 bits of 64 bit time tag field representing microseconds	FLOAT32	0 - 65535
Line_mean	Active pixel region line average	FLOAT32	0 - 16383

Table 4-6: CCD Science Per-Line Metadata. (Continued)

PerLine Metadata	Definition	Data Type	Valid Range
Std_dev_ac	Active pixel region standard deviation	FLOAT32	0 - 400
Min_ac_dn	Minimum DN value in active pixel region	FLOAT32	0 - 16383
Max_ac_dn	Maximum DN value in active pixel region	FLOAT32	0 - 16383
Overclock_mean	Overclock pixel region line average	FLOAT32	0 - 1000
Std_dev_oc	Overclock pixel region standard deviation	FLOAT32	0 - 400
Min_oc_dn	Minimum DN value in overclock pixel region	FLOAT32	0 - 16383
Max_oc_dn	Maximum DN value in overclock pixel region	FLOAT32	0 - 16383
rti_eosec	Number of 8 ms intervals, eosec -> MSYNC	FLOAT32	0 - 5
Ccd_int_time	CCD line integration time	FLOAT32	0 - 40.8 ms
Cam_mode_flag	Camera mode (global/local)	FLOAT32	0=Local, 1=Global

4.5.5 Per-pixel Metadata Description

None.

4.5.6 Swath Data Set Descriptions

Table 4-7: CCD Science Swath Field Definitions

Field Name Parameter Description	Dimension List	Number Type	Units	Transformation	Flag Values
Swath blue_band_1x1					
DNs	DownTrack, CrossTrack	UINT16	dn	Bit packed: Bits 0-1 = IDQI Bits 2-15 = dn	IDQI: 0 = Within specifications 1 = Reduced accuracy 2 = Not usable for science 3 = Unusable for any purpose
Swath_blue_anc_1x1					
(Field definitions described Table [4-6])					
Swath green_band_1x1					

Table 4-7: CCD Science Swath Field Definitions (Continued)

Field Name Parameter Description	Dimension List	Number Type	Units	Transformation	Flag Values
DNs	DownTrack, CrossTrack	UINT16	dn	Bit packed: Bits 0-1 = IDQI Bits 2-15 = dn	IDQI: 0 = Within specifications 1 = Reduced accuracy 2 = Not usable for science 3 = Unusable for any purpose
Swath green_anc_1x1					
(Field definitions described Table [4-6])					
Swath red_band_1x1					
DNs	DownTrack, CrossTrack	UINT16	dn	Bit packed: Bits 0-1 = IDQI Bits 2-15 = dn	IDQI: 0 = Within specifications 1 = Reduced accuracy 2 = Not usable for science 3 = Unusable for any purpose
Swath red_anc_1x1					
(Field definitions described Table [4-6])					
Swath nir_band_1x1					
DNs	DownTrack, CrossTrack	UINT16	dn	Bit packed: Bits 0-1 = IDQI Bits 2-15 = dn	IDQI: 0 = Within specifications 1 = Reduced accuracy 2 = Not usable for science 3 = Unusable for any purpose
Swath nir_anc_1x1					
(Field definitions described Table [4-6])					
Swath blue_band_1x4					
DNs	DownTrack, CrossTrack	UINT16	dn	Bit packed: Bits 0-1 = IDQI Bits 2-15 = dn	IDQI: 0 = Within specifications 1 = Reduced accuracy 2 = Not usable for science 3 = Unusable for any purpose
Swath blue_anc_1x4					
(Field definitions described Table [4-6])					
Swath green_band_1x4					

Table 4-7: CCD Science Swath Field Definitions (Continued)

Field Name Parameter Description	Dimension List	Number Type	Units	Transformation	Flag Values
DNs	DownTrack, CrossTrack	UINT16	dn	Bit packed: Bits 0-1 = IDQI Bits 2-15 = dn	IDQI: 0 = Within specifications 1 = Reduced accuracy 2 = Not usable for science 3 = Unusable for any purpose
Swath green_anc_1x4					
(Field definitions described Table [4-6])					
Swath red_band_1x4					
DNs	DownTrack, CrossTrack	UINT16	dn	Bit packed: Bits 0-1 = IDQI Bits 2-15 = dn	IDQI: 0 = Within specifications 1 = Reduced accuracy 2 = Not usable for science 3 = Unusable for any purpose
Swath red_anc_1x4					
(Field definitions described Table [4-6])					
Swath nir_band_1x4					
DNs	DownTrack, CrossTrack	UINT16	dn	Bit packed: Bits 0-1 = IDQI Bits 2-15 = dn	IDQI: 0 = Within specifications 1 = Reduced accuracy 2 = Not usable for science 3 = Unusable for any purpose
Swath nir_anc_1x4					
(Field definitions described Table [4-6])					
Swath blue_band_2x2					
DNs	DownTrack, CrossTrack	UINT16	dn	Bit packed: Bits 0-1 = IDQI Bits 2-15 = dn	IDQI: 0 = Within specifications 1 = Reduced accuracy 2 = Not usable for science 3 = Unusable for any purpose
Swath blue_anc_2x2					
(Field definitions described Table [4-6])					
Swath green_band_2x2					

Table 4-7: CCD Science Swath Field Definitions (Continued)

Field Name Parameter Description	Dimension List	Number Type	Units	Transformation	Flag Values
DNs	DownTrack, CrossTrack	UINT16	dn	Bit packed: Bits 0-1 = IDQI Bits 2-15 = dn	IDQI: 0 = Within specification 1 = Reduced accuracy 2 = Not usable for science 3 = Unusable for any purpose
Swath green_anc_2x2					
(Field definitions described Table [4-6])					
Swath red_band_2x2					
DNs	DownTrack, CrossTrack	UINT16	dn	Bit packed: Bits 0-1 = IDQI Bits 2-15 = dn	IDQI: 0 = Within specifications 1 = Reduced accuracy 2 = Not usable for science 3 = Unusable for any purpose
Swath red_anc_2x2					
(Field definitions described Table [4-6])					
Swath nir_band_2x2					
DNs	DownTrack, CrossTrack	UINT16	dn	Bit packed: Bits 0-1 = IDQI Bits 2-15 = dn	IDQI: 0 = Within specifications 1 = Reduced accuracy 2 = Not usable for science 3 = Unusable for any purpose
Swath red_anc_2x2					
(Field definitions described Table [4-6])					
Swath blue_band_4x4					
DNs	DownTrack, CrossTrack	UINT16	dn	Bit packed: Bits 0-1 = IDQI Bits 2-15 = dn	IDQI: 0 = Within specifications 1 = Reduced accuracy 2 = Not usable for science 3 = Unusable for any purpose
Swath blue_anc_4x4					
(Field definitions described Table [4-6])					
Swath green_band_4x4					

Table 4-7: CCD Science Swath Field Definitions (Continued)

Field Name Parameter Description	Dimension List	Number Type	Units	Transformation	Flag Values
DNs	DownTrack, CrossTrack	UINT16	dn	Bit packed: Bits 0-1 = IDQI Bits 2-15 = dn	IDQI: 0 = Within specifications 1 = Reduced accuracy 2 = Not usable for science 3 = Unusable for any purpose
Swath green_anc_4x4					
(Field definitions described Table [4-6])					
Swath red_band_4x4					
DNs	DownTrack, CrossTrack	UINT16	dn	Bit packed: Bits 0-1 = IDQI Bits 2-15 = dn	IDQI: 0 = Within specifications 1 = Reduced accuracy 2 = Not usable for science 3 = Unusable for any purpose
Swath red_anc_4x4					
(Field definitions described Table [4-6])					
Swath nir_band_4x4					
DNs	DownTrack, CrossTrack	UINT16	dn	Bit packed: Bits 0-1 = IDQI Bits 2-15 = dn	IDQI: 0 = Within specifications 1 = Reduced accuracy 2 = Not usable for science 3 = Unusable for any purpose
Swath nir_anc_4x4					
(Field definitions described Table [4-6])					
Swath spurious_pkts					
SpuriousPkts	PktDownTrack, PktCrossTrack	UCHAR8	n/a	n/a	n/a

4.5.7 CCD Science Product QA

Additional Quality Assessment Metadata is no longer reported in HDF-EOS vdata structures.

Separate QA Statistics files are no longer generated.

4.6 MISR LEVEL 1A MI1AC CCD CALIBRATION DATA

4.6.1 File Metadata Description

None.

4.6.2 Per-swath Metadata Description

Table 4-8: CCD Calibration Per-swath Metadata.

Swath Metadata	Definition	Data Type	Valid Values
PGE4_ORBIT_NO	Orbit counter	INT32	1-
PGE4_PATH_NO	Orbit path counter	INT32	1-233
PGE4_OUT_OF_ORDER_PKTS	Listing of out of order packets found	INT16	(Array of 50)
PGE4_DUPLICATE_PKTS	Listing of duplicate packets found	INT16	(Array of 50)
PGE4_PIXEL_REVERSAL	Pixel reversal determinant	INT32	0/1

4.6.3 Per-block Metadata Description

None.

4.6.4 Per-line Metadata Description

The CCD Calibration Data file uses primarily Per-Line Metadata (Table 4-9). Per-Line Metadata is stored in the TimeTags SDS linked to the DNs SDS by sharing the same X-Dim.

Table 4-9: CCD Calibration Per-Line Metadata

PerLine Metadata	Definition	Data Type	Valid Range
time_days	Time tag(0) -first 16 bits of 64 bit time tag field representing days	FLOAT32	0 - 65535
time_msec1	Time tag(1) - second 16 bits of 64 bit time tag field representing milliseconds	FLOAT32	0 - 65535
time_msec2	Time tag(2) - third 16 bits of 64 bit time tag field representing milliseconds	FLOAT32	0 - 65535
time_micro	Time tag(3) - fourth 16 bits of 64 bit time tag field representing microseconds	FLOAT32	0 - 65535
Line_mean	Active pixel region line average	FLOAT32	0 - 16383

Table 4-9: CCD Calibration Per-Line Metadata (Continued)

PerLine Metadata	Definition	Data Type	Valid Range
Std_dev_ac	Active pixel region standard deviation	FLOAT32	0 - 400
Min_ac_dn	Active pixel region standard deviation	FLOAT32	0
Max_ac_dn	Maximum DN value in active pixel region	FLOAT32	16383
Overclock_mean	Overclock pixel region line average	FLOAT32	0 - 1000
Std_dev_oc	Overclock pixel region standard deviation	FLOAT32	0 - 400
Min_oc_dn	Minimum DN value in overclock pixel region	FLOAT32	0
Max_oc_dn	Maximum DN value in overclock pixel region	FLOAT32	16383
Sun_angle_x	Sun angle - x coordinate	FLOAT32	
Sun_angle_y	Sun angle - y coordinate	FLOAT32	
Sun_angle_z	Sun angle - z coordinate	FLOAT32	
Ccd_int_time	CCD line integration time	FLOAT32	0 - 40.8

4.6.5 Per-pixel Metadata Description

None.

4.6.6 Swath Data Set Descriptions

For CCD calibration processing, the data collected during any of the types of calibration sequence modes (North pole, South pole, Dark, Diode) is stored in an appropriate SDS based on band and averaging mode. Since the cameras are taken through multiple averaging modes and integration times during any one calibration operation the data collected is stored in time order in the appropriate band/averaging mode defined SDSs. Ancillary metadata for each set of calibration DNs (including time tag) are defined in Table 4-10.

Table 4-10: CCD Calibration Swath Field Definitions

Field Name Parameter Description	Dimension List	Number Type	Units	Transformation	Flag Values
Swath blue_band_1x1					
DNs	DownTrack, CrossTrack	UINT16	dn	Bit packed: Bits 0-1 = SDQI Bits 2-15 = dn	SDQI: 0 = No known anomalies 1 = Overclock out-of-range 2 = Saturated pixels 3 = Data transmission errors

Table 4-10: CCD Calibration Swath Field Definitions (Continued)

Field Name Parameter Description	Dimension List	Number Type	Units	Transformation	Flag Values
Swath_blue_anc_1x1					
(Field definitions described Table 4-10)					
Swath_green_band_1x1					
DNs	DownTrack, CrossTrack	UINT16	dn	Bit packed: Bits 0-1 = SDQI Bits 2-15 = dn	SDQI: 0 = No known anomalies 1 = Overclock out-of-range 2 = Saturated pixels 3 = Data transmission errors
Swath_green_anc_1x1					
(Field definitions described Table 4-10)					
Swath_red_band_1x1					
DNs	DownTrack, CrossTrack	UINT16	dn	Bit packed: Bits 0-1 = SDQI Bits 2-15 = dn	SDQI: 0 = No known anomalies 1 = Overclock out-of-range 2 = Saturated pixels 3 = Data transmission errors
Swath_red_anc_1x1					
(Field definitions described Table 4-10)					
Swath_nir_band_1x1					
DNs	DownTrack, CrossTrack	UINT16	dn	Bit packed: Bits 0-1 = SDQI Bits 2-15 = dn	SDQI: 0 = No known anomalies 1 = Overclock out-of-range 2 = Saturated pixels 3 = Data transmission errors
Swath_nir_anc_1x1					
(Field definitions described Table 4-10)					
Swath_blue_band_1x4					
DNs	DownTrack, CrossTrack	UINT16	dn	Bit packed: Bits 0-1 = SDQI Bits 2-15 = dn	SDQI: 0 = No known anomalies 1 = Overclock out-of-range 2 = Saturated pixels 3 = Data transmission errors
Swath_blue_anc_1x4					
(Field definitions described Table 4-10)					
Swath_green_band_1x4					

Table 4-10: CCD Calibration Swath Field Definitions (Continued)

Field Name Parameter Description	Dimension List	Number Type	Units	Transformation	Flag Values
DNs	DownTrack, CrossTrack	UINT16	dn	Bit packed: Bits 0-1 = SDQI Bits 2-15 = dn	SDQI: 0 = No known anomalies 1 = Overclock out-of-range 2 = Saturated pixels 3 = Data transmission errors
Swath green_anc_1x4					
(Field definitions described Table 4-10)					
Swath red_band_1x4					
DNs	DownTrack, CrossTrack	UINT16	dn	Bit packed: Bits 0-1 = SDQI Bits 2-15 = dn	SDQI: 0 = No known anomalies 1 = Overclock out-of-range 2 = Saturated pixels 3 = Data transmission errors
Swath red_anc_1x4					
(Field definitions described Table 4-10)					
Swath nir_band_1x4					
DNs	DownTrack, CrossTrack	UINT16	dn	Bit packed: Bits 0-1 = SDQI Bits 2-15 = dn	SDQI: 0 = No known anomalies 1 = Overclock out-of-range 2 = Saturated pixels 3 = Data transmission errors
Swath nir_anc_1x4					
(Field definitions described Table 4-10)					
Swath blue_band_2x2					
DNs	DownTrack, CrossTrack	UINT16	dn	Bit packed: Bits 0-1 = SDQI Bits 2-15 = dn	SDQI: 0 = No known anomalies 1 = Overclock out-of-range 2 = Saturated pixels 3 = Data transmission errors
Swath blue_anc_2x2					
(Field definitions described Table 4-10)					
Swath green_band_2x2					
DNs	DownTrack, CrossTrack	UINT16	dn	Bit packed: Bits 0-1 = SDQI Bits 2-15 = dn	SDQI: 0 = No known anomalies 1 = Overclock out-of-range 2 = Saturated pixels 3 = Data transmission errors

Table 4-10: CCD Calibration Swath Field Definitions (Continued)

Field Name Parameter Description	Dimension List	Number Type	Units	Transformation	Flag Values
Swath green_anc_2x2					
(Field definitions described Table 4-10)					
Swath red_band_2x2					
DNs	DownTrack, CrossTrack	UINT16	dn	Bit packed: Bits 0-1 = SDQI Bits 2-15 = dn	SDQI: 0 = No known anomalies 1 = Overclock out-of-range 2 = Saturated pixels 3 = Data transmission errors
Swath red_anc_2x2					
(Field definitions described Table 4-10)					
Swath nir_band_2x2					
DNs	DownTrack, CrossTrack	UINT16	dn	Bit packed: Bits 0-1 = SDQI Bits 2-15 = dn	SDQI: 0 = No known anomalies 1 = Overclock out-of-range 2 = Saturated pixels 3 = Data transmission errors
Swath red_anc_2x2					
(Field definitions described Table 4-10)					
Swath blue_band_4x4					
DNs	DownTrack, CrossTrack	UINT16	dn	Bit packed: Bits 0-1 = SDQI Bits 2-15 = dn	SDQI: 0 = No known anomalies 1 = Overclock out-of-range 2 = Saturated pixels 3 = Data transmission errors
Swath blue_anc_4x4					
(Field definitions described Table 4-10)					
Swath green_band_4x4					
DNs	DownTrack, CrossTrack	UINT16	dn	Bit packed: Bits 0-1 = SDQI Bits 2-15 = dn	SDQI: 0 = No known anomalies 1 = Overclock out-of-range 2 = Saturated pixels 3 = Data transmission errors
Swath green_anc_4x4					
(Field definitions described Table 4-10)					
Swath red_band_4x4					

Table 4-10: CCD Calibration Swath Field Definitions (Continued)

Field Name Parameter Description	Dimension List	Number Type	Units	Transformation	Flag Values
DNs	DownTrack, CrossTrack	UINT16	dn	Bit packed: Bits 0-1 = SDQI Bits 2-15 = dn	SDQI: 0 = No known anomalies 1 = Overclock out-of-range 2 = Saturated pixels 3 = Data transmission errors
Swath red_anc_4x4					
(Field definitions described Table 4-10)					
Swath nir_band_4x4					
DNs	DownTrack, CrossTrack	UINT16	dn	Bit packed: Bits 0-1 = SDQI Bits 2-15 = dn	SDQI: 0 = No known anomalies 1 = Overclock out-of-range 2 = Saturated pixels 3 = Data transmission errors
Swath nir_anc_4x4					
(Field definitions described Table 4-10)					
Swath spurious_pkts	PktDownTrack, PktCrossTrack	UCHAR8	n/a	n/a	n/a

4.6.7 Per-swath QA Metadata

None.



4.7 MISR LEVEL 1A MI1AMOT MOTOR DATA

4.7.1 File Metadata Description

None.

4.7.2 Per-swath Metadata Description

Table 4-11: Motor Per-swath Metadata.

Swath Metadata	Definition	Data Type	Valid Values
PGE3_ORBIT_NO	Orbit counter	INT32	1-
PGE3_PATH_NO	Orbit path counter	INT32	1-233
PGE3_START_TIME	Calibration start time	FLOAT64	S/C time
PGE3_STOP_TIME	Calibration stop time	FLOAT64	S/C time
PGE3_NUM_MTR_SAMPLES	Number of motor samples	INT32	
PGE3_SWATH_FLAGS	Quality flag for calibration	INT8	1-128
PGE3_OUT_OF_ORDER_PKTS	Listing of out of order packets found	INT16	(Array of 50)
PGE3_DUPLICATE_PKTS	Listing of duplicate packets found	INT16	(Array of 50)

4.7.3 Per-block Metadata Description

None.

4.7.4 Per-line Metadata Description

None.

4.7.5 Per-pixel (or -sample) Metadata Description

Table 4-12 describes the Per-sample Metadata that are specific to each data sample in a packet during the calibration sequence. For each data value in the motor current SDS there is a corresponding metadata value in the corresponding metadata SDS.

Table 4-12: Motor Data Per-Sample Metadata

PerPacket Metadata	Definition	Data Type	Valid Range
Current sample quality indicators	<p>Quality values associated with each motor current sample. Using bit-level triggers the quality flag is toggled as follows:</p> <p>bit 0: Data extraction error bit 1: Data scaling error bit 2: Data byte alignment error bit 3: Data failed threshold check, high bit 4: Data failed threshold check, low bit 5: Unused bit 6: Unused bit 7: Data value is OK.</p>	INT8	(Array of 283)

4.7.6 Swath Data Set Descriptions

For MISR calibration processing the data collected during any of the types of calibration sequence modes (North pole, South pole, Dark, Diode) generates motor data which is stored in the MISR L1A Motor output product. Data quality checks are performed on all current samples and time tags in the packet.

Table 4-13: Motor Data Dimension Descriptions

Dimension	Description	Valid Values
PGE3_TIME_DIMENSION	Unlimited, time tag for each motor packet collected	0 -
PGE3_TIME_XTRACK_DIMENSION	Number of bytes in a motor packet time tag	8
PGE3_DOWN_TRACK_DIMENSION	Unlimited, number of lines acquired during the collection of MISR motor data	0 -
PGE3_CURR_DIMENSION	Number of current sampled acquired	283
PGE3_META_XTRACK_DIMENSION	Number of metadata values per packet	4

Table 4-14: Motor Data Swath Field Definitions

Field Name Parameter Description	Dimension List	Number Type
PGE3_CURR_SAMPLE_TIME_TABLE	PGE3_DOWN_TRACK_DIMENSION, PGE3_TIME_XTRACK_DIMENSION	UINT8
PGE3_PACKET_QUAL_TABLE	PGE3_DOWN_TRACK_DIMENSION	UINT32



Table 4-14: Motor Data Swath Field Definitions (Continued)

Field Name Parameter Description	Dimension List	Number Type
PGE3_PACKET_META_TABLE	PGE3_DOWN_TRACK_DIMENSION, PGE3_PACKET_META_XTRACK_DIMENSION	FLOAT32
PGE3_CURR_SAMPLE_TABLE	PGE3_DOWN_TRACK_DIMENSION, PGE3_CURR_DIMENSION	FLOAT32
PGE3_DATA_QUAL_TABLE	PGE3_DOWN_TRACK_DIMENSION, PGE3_CURR_DIMENSION	UINT8

Table 4-15 lists the data fields in the swath based on the location the data has been collected on the instrument. Each represents an SDS in the output MISR motor file.

Table 4-15: Swath Data fields for Motor Data

Field Name	Description	Data Type	Valid Range
PGE3_curr_sample_time_table			
time_days	Time tag -first 16 bits of 64 bit time tag field representing days (array of 2 bytes)	FLOAT32	0 - 65536
time_msec1	Time tag - second 16 bits of 64 bit time tag field representing milliseconds (array of 2 bytes)	FLOAT32	0 - 65536
time_msec2	Time tag - third 16 bits of 64 bit time tag field representing milliseconds (array of 2 bytes)	FLOAT32	0 - 65536
time_micro	Time tag - fourth 16 bits of 64 bit time tag field representing microseconds (array of 2 bytes)	FLOAT32	0 - 1000
PGE3_packet_quality			



Table 4-15: Swath Data fields for Motor Data (Continued)

Field Name	Description	Data Type	Valid Range
qual_indicator	Motor packet data quality indicator Quality values associated with each motor packet. Using bit-level triggers the quality flag is toggled as follows: Bit 0: Packet header has an error Bit 1: Bad packet APID Bit 2: Invalid packet length Bit 3: Bad packet time stamp Bit 4: Packet time out of order Bit 7: Packet sequence number out of order	INT8	0 - 128
PGE3_packet_meta_table			
motor_id	Motor identifier 0 = North cal panel 1 = South cal panel 3 = cover	INT32	0 - 2
motor_temperature	Motor temperature	FLOAT32	-30 to 50
curr_samp_freq	Motor current sampling frequency	FLOAT32	40ms
tot_num_curr_samples	Number of currents samples	INT32	0 -
PGE3_curr_sample_table			
curr_sample	Motor current sample values (array of 283)	FLOAT32	0 - 2110ma
PGE3_data_qual_table			
(Field definitions described Table 4-14)			

4.7.7 Per-swath QA Metadata

None.

4.8 MISR LEVEL 1A MI1ANAV NAVIGATION DATA

4.8.1 File Metadata Description

None.

4.8.2 Per-swath Metadata Description

Table 4-16: NAVIGATION Per-swath Metadata.

Swath Metadata	Definition	Data Type	Valid Values
PGE2_ORBIT_NO	Orbit counter	INT32	1-
PGE2_PATH_NO	Orbit path counter	INT32	1-233
PGE2_START_TIME	Calibration start time	FLOAT64	S/C time
PGE2_STOP_TIME	Calibration stop time	FLOAT64	S/C time
PGE2_NUMBER_OF_PACKETS	Number of Navigation packets	INT32	0 -
PGE2_SWATH_FLAGS	Quality flag for engineering data collection	INT8	1-128
PGE2_OUT_OF_ORDER_PKTS	Listing of out of order packets found	INT16	(Array of 50)
PGE2_DUPLICATE_PKTS	Listing of duplicate packets found	INT16	(Array of 50)

4.8.3 Per-block Metadata Description

None.

4.8.4 Per-line Metadata Description

None.

4.8.5 Per-pixel (or -sample) Metadata Description

The Engineering Data file uses primarily Per-sample Metadata (Table 4-17). Each multiplexer (MUX), or Camera-specific data, retrieved from the instrument is stored in a separate SDS in the output file.

Table 4-17: Navigation Per-Sample Metadata

PerLine Metadata	Definition	Data Type	Valid Range
Navigation values quality indicators	<p>Quality values associated with each navigation data values. Using bit-level triggers the quality flag is toggled as follows:</p> <p>bit 0: Data extraction error bit 1: Data scaling error bit 2: Data byte alignment error bit 3: Data failed threshold check, high bit 4: Data failed threshold check, low bit 5: Unused bit 6: Unused bit 7: Data value is OK.</p>	INT8	(Array of 13)

4.8.6 Swath Data Set Descriptions

For MISR Engineering/navigation data collected during an EOS orbit the data generated is stored in an appropriate SDS in the output product. The navigation data and data quality indicators describing the values are stored in the swath and data dimensions are defined below.

Table 4-18: Navigation Data Dimension Descriptions

Dimension	Description	Valid Values
PGE2_DOWN_TRACK_DIMENSION	Unlimited, number of lines acquired during the collection of MISR engineering data	0 -
PGE2_NAVIGATION_DIMENSION	Navigation sample values	13
PGE2_TIME_DIMENSION	Unlimited, time tag for each engineering packet collected	0 -
PGE2_TIME_ARRAY_DIMENSION	Number of bytes in a engineering/navigation packet time tag	8

Table 4-19: Navigation Data Swath Field Definitions

Field Name Parameter Description	Dimension List	Number Type
Swath NavSwath		
PGE2_PACKET_QUAL	PGE2_DOWN_TRACK_DIMENSION	UINT32

Table 4-19: Navigation Data Swath Field Definitions

Field Name Parameter Description	Dimension List	Number Type
PGE2_NAVIGATION_TABLE	PGE2_DOWN_TRACK_DIMENSION, PGE2_NAVIGATION_DIMENSION	FLOAT32
PGE2_NAVIGATION_QUAL	PGE2_DOWN_TRACK_DIMENSION, PGE2_NAVIGATION_DIMENSION	UINT8
PGE2_TIME_TABLE	PGE2_TIME_DIMENSION, PGE2_TIME_ARRAY_DIMENSION	UINT8

Table 4-20 lists the data fields in the swath based on the location the data has been collected on the instrument. Each represents an SDS in the output MISR navigation file.

Table 4-20: Swath Data Fields for Navigation Data

Field Name	Description	Data Type	Valid Range
PGE2_time_table			
time_days	Time tag -first 16 bits of 64 bit time tag field representing days (array of 2 bytes)	FLOAT32	0 - 65536
time_msec1	Time tag - second 16 bits of 64 bit time tag field representing milliseconds (array of 2 bytes)	FLOAT32	0 - 65536
time_msec2	Time tag - third 16 bits of 64 bit time tag field representing milliseconds (array of 2 bytes)	FLOAT32	0 - 65536
time_micro	Time tag - fourth 16 bits of 64 bit time tag field representing microseconds (array of 2 bytes)	FLOAT32	0 - 1000
PGE2_packet_qual			
qual_indicator	Motor packet data quality indicator Quality values associated with each motor packet. Using bit-level triggers the quality flag is toggled as follows: Bit 0: Virtual data file could not be opened Bit 1: Header file could not be read Bit 2: Header packet count wrong Bit 3: Header spacecraft id wrong Bit 4: Header time stamp wrong Bit 7: Swath OK flag	INT8	0 - 128

Table 4-20: Swath Data Fields for Navigation Data (Continued)

Field Name	Description	Data Type	Valid Range
PGE2_navigation_table			
x_axis_pos	X-axis position (m)	FLOAT32	$\pm 268 \times 10^6$
y_axis_pos	Y-axis position (m)	FLOAT32	$\pm 268 \times 10^6$
z_axis_pos	Z-axis position (m)	FLOAT32	$\pm 268 \times 10^6$
x_axis_vel	X-axis velocity (m/s)	FLOAT32	$\pm 524 \times 10^3$
y_axis_vel	Y-axis velocity (m/s)	FLOAT32	$\pm 524 \times 10^3$
z_axis_vel	Z-axis velocity (m/s)	FLOAT32	$\pm 524 \times 10^3$
roll_axis_angle	Roll-axis Euler angle (arcsec)	FLOAT32	± 2048
pitch_axis_angle	Pitch-axis Euler angle (arcsec)	FLOAT32	± 2048
yaw_axis_angle	Yaw-axis Euler angle (arcsec)	FLOAT32	± 2048
roll_axis_rate	Roll-axis rotation rate (arcsec/s)	FLOAT32	± 1024
pitch_axis_rate	Pitch-axis rotation rate (arcsec/s)	FLOAT32	± 1024
yaw_axis_rate	Yaw-axis rotation rate (arcsec/s)	FLOAT32	± 1024
PGE2_packet_meta_table			
(Field definitions described Table 4-19)			

4.8.7 Per-swath QA Metadata

None.

4.9 MISR LEVEL 1A MI1AENG1 ENGINEERING DATA

4.9.1 File Metadata Description

None.

4.9.2 Per-swath Metadata Description

Table 4-21: Swath Metadata for Engineering Data File

Swath Metadata	Definition	Data Type	Valid Values
PGE2_ORBIT_NO	Orbit counter	INT32	1-
PGE2_PATH_NO	Orbit path counter	INT32	1-233
PGE2_START_TIME	Calibration start time	FLOAT64	S/C time
PGE2_STOP_TIME	Calibration stop time	FLOAT64	S/C time
PGE2_NUMBER_OF_PACKETS	Number of Engineering packets	INT32	
PGE2_SWATH_FLAGS	Quality flag for engineering data collection	INT8	1-128
PGE2_OUT_OF_ORDER_PKTS	Listing of out of order packets found	INT16	(Array of 50)
PGE2_DUPLICATE_PKTS	Listing of duplicate packets found	INT16	(Array of 50)

4.9.3 Per-block Metadata Description

None.

4.9.4 Per-line Metadata Description

None.

4.9.5 Per-pixel (or -sample) Metadata Description

The Engineering Data file uses primarily Per-sample Metadata (Table 4-22). Each multiplexer (MUX), or Camera-specific data, retrieved from the instrument is stored in a separate SDS in the output file.

Table 4-22: Engineering Data Per-Sample Metadata

PerLine Metadata	Definition	Data Type	Valid Range
Mux A quality indicators	<p>Quality values associated with each engineering values collected in MUX A. Using bit-level triggers the quality flag is toggled as follows:</p> <p>bit 0: Data extraction error bit 1: Data scaling error bit 2: Data byte alignment error bit 3: Data failed threshold check, high bit 4: Data failed threshold check, low bit 5: Unused bit 6: Unused bit 7: Data value is OK.</p>	INT8	Array of 16, each correlating to an engineering value collected, 0-128
Mux B quality indicators	<p>Quality values associated with each engineering values collected in MUX B. Using bit-level triggers the quality flag is toggled as follows:</p> <p>bit 0: Data extraction error bit 1: Data scaling error bit 2: Data byte alignment error bit 3: Data failed threshold check, high bit 4: Data failed threshold check, low bit 5: Unused bit 6: Unused bit 7: Data value is OK.</p>	INT8	Array of 16, each correlating to an engineering value collected, 0-128
Mux C quality indicators	<p>Quality values associated with each engineering values collected in MUX C. Using bit-level triggers the quality flag is toggled as follows:</p> <p>bit 0: Data extraction error bit 1: Data scaling error bit 2: Data byte alignment error bit 3: Data failed threshold check, high bit 4: Data failed threshold check, low bit 5: Unused bit 6: Unused bit 7: Data value is OK.</p>	INT8	Array of 16, each correlating to an engineering value collected, 0-128



Table 4-22: Engineering Data Per-Sample Metadata (Continued)

PerLine Metadata	Definition	Data Type	Valid Range
Mux D quality indicators	<p>Quality values associated with each engineering values collected in MUX D. Using bit-level triggers the quality flag is toggled as follows:</p> <p>bit 0: Data extraction error bit 1: Data scaling error bit 2: Data byte alignment error bit 3: Data failed threshold check, high bit 4: Data failed threshold check, low bit 5: Unused bit 6: Unused bit 7: Data value is OK.</p>	INT8	Array of 16, each correlating to an engineering value collected, 0-128
Camera quality indicator	<p>Quality values associated with each Camera engineering data value collected. Using bit-level triggers the quality flag is toggled as follows:</p> <p>bit 0: Data extraction error bit 1: Data scaling error bit 2: Data byte alignment error bit 3: Data failed threshold check, high bit 4: Data failed threshold check, low bit 5: Unused bit 6: Unused bit 7: Data value is OK.</p>	INT8	<p>Array of 16, each correlating to a camera engineering value collected, 0-128</p> <p>(Note: There are nine occurrences of this data set, one for each camera)</p>
Temperature quality indicator	<p>Quality values associated with each temperature value collected. Using bit-level triggers the quality flag is toggled as follows:</p> <p>bit 0: Data extraction error bit 1: Data scaling error bit 2: Data byte alignment error bit 3: Data failed threshold check, high bit 4: Data failed threshold check, low bit 5: Unused bit 6: Unused bit 7: Data value is OK.</p>	INT8	Array of 15, each correlating to a temperature value collected, 0-128



Table 4-22: Engineering Data Per-Sample Metadata (Continued)

PerLine Metadata	Definition	Data Type	Valid Range
Auxiliary quality indicator	<p>Quality values associated with each auxiliary value collected. Using bit-level triggers the quality flag is toggled as follows:</p> <p>bit 0: Data extraction error bit 1: Data scaling error bit 2: Data byte alignment error bit 3: Data failed threshold check, high bit 4: Data failed threshold check, low bit 5: Unused bit 6: Unused bit 7: Data value is OK.</p>	INT8	Array of 13, each correlating to an engineering auxiliary value collected, 0-128

4.9.6 Swath Data Set Descriptions

For MISR Engineering/Navigation data collected during an EOS orbit the data generated is separated by source (MUX,Camera,...) and stored in an appropriate SDS in the output product. Descriptions of the swath and data dimensions are defined below.

Table 4-23: Engineering Data Dimension Descriptions

Dimension	Description	Valid Values
PGE2_DOWN_TRACK_DIMENSION	Unlimited, number of lines acquired during the collection of MISR engineering data	0 -
PGE2_SWITCH_DIMENSION	Limit switch flags in the MISR engineering/navigation data	10
PGE2_MUX_DIMENSION	Data from the MISR multiplexer's system ESC ADC	16
PGE2_CAMERA_DIMENSION	Data from the MISR camera engineering data	16
PGE2_TEMPERATURE_DIMENSION	Data from the MISR instrument temperature readings	10
PGE2_AUXILARY_DIMENSION	Auxiliary quality flags from MISR eng/nav packet	13
PGE2_TIME_DIMENSION	Unlimited, time tag for each engineering packet collected	0 -
PGE2_TIME_ARRAY_DIMENSION	Number of bytes in a engineering/navigation packet time tag	8



Table 4-24: Engineering Data Swath Field Definitions

Field Name Parameter Description	Dimension List	Number Type
PGE2_PACKET_QUAL	PGE2_DOWN_TRACK_DIMENSION,	UINT8
PGE2_SWITCH_TABLE	PGE2_DOWN_TRACK_DIMENSION, PGE2_SWITCH_DIMENSION	UINT8
PGE2_MUX_1_TABLE	PGE2_DOWN_TRACK_DIMENSION, PGE2_MUX_DIMENSION	FLOAT32
PGE2_MUX_1_QUAL	PGE2_DOWN_TRACK_DIMENSION, PGE2_MUX_DIMENSION	UINT8
PGE2_MUX_B_TABLE	PGE2_DOWN_TRACK_DIMENSION, PGE2_MUX_DIMENSION	FLOAT32
PGE2_MUX_B_QUAL	PGE2_DOWN_TRACK_DIMENSION, PGE2_MUX_DIMENSION	UINT8
PGE2_MUX_C_TABLE	PGE2_DOWN_TRACK_DIMENSION, PGE2_MUX_DIMENSION	FLOAT32
PGE2_MUX_C_QUAL	PGE2_DOWN_TRACK_DIMENSION, PGE2_MUX_DIMENSION	UINT8
PGE2_MUX_D_TABLE	PGE2_DOWN_TRACK_DIMENSION, PGE2_MUX_DIMENSION	FLOAT32
PGE2_MUX_D_QUAL	PGE2_DOWN_TRACK_DIMENSION, PGE2_MUX_DIMENSION	UINT8
PGE2_CAMERA_TABLE	PGE2_DOWN_TRACK_DIMENSION, PGE2_CAMERA_DIMENSION	FLOAT32
PGE2_CAMERA_QUAL	PGE2_DOWN_TRACK_DIMENSION, PGE2_CAMERA_DIMENSION	UINT8
PGE2_CAMERA_TABLE	PGE2_DOWN_TRACK_DIMENSION, PGE2_CAMERA_DIMENSION	FLOAT32
PGE2_CAMERA_QUAL	PGE2_DOWN_TRACK_DIMENSION, PGE2_CAMERA_DIMENSION	UINT8
PGE2_CAMERA_TABLE	PGE2_DOWN_TRACK_DIMENSION, PGE2_CAMERA_DIMENSION	FLOAT32
PGE2_CAMERA_QUAL	PGE2_DOWN_TRACK_DIMENSION, PGE2_CAMERA_DIMENSION	UINT8
PGE2_CAMERA_TABLE	PGE2_DOWN_TRACK_DIMENSION, PGE2_CAMERA_DIMENSION	FLOAT32
PGE2_CAMERA_QUAL	PGE2_DOWN_TRACK_DIMENSION, PGE2_CAMERA_DIMENSION	UINT8



Table 4-24: Engineering Data Swath Field Definitions (Continued)

Field Name Parameter Description	Dimension List	Number Type
PGE2_CAMERA_TABLE	PGE2_DOWN_TRACK_DIMENSION, PGE2_CAMERA_DIMENSION	FLOAT32
PGE2_CAMERA_QUAL	PGE2_DOWN_TRACK_DIMENSION, PGE2_CAMERA_DIMENSION	UINT8
PGE2_CAMERA_TABLE	PGE2_DOWN_TRACK_DIMENSION, PGE2_CAMERA_DIMENSION	FLOAT32
PGE2_CAMERA_QUAL	PGE2_DOWN_TRACK_DIMENSION, PGE2_CAMERA_DIMENSION	UINT8
PGE2_CAMERA_TABLE	PGE2_DOWN_TRACK_DIMENSION, PGE2_CAMERA_DIMENSION	FLOAT32
PGE2_CAMERA_QUAL	PGE2_DOWN_TRACK_DIMENSION, PGE2_CAMERA_DIMENSION	UINT8
PGE2_CAMERA_TABLE	PGE2_DOWN_TRACK_DIMENSION, PGE2_CAMERA_DIMENSION	FLOAT32
PGE2_CAMERA_QUAL	PGE2_DOWN_TRACK_DIMENSION, PGE2_CAMERA_DIMENSION	UINT8
PGE2_CAMERA_TABLE	PGE2_DOWN_TRACK_DIMENSION, PGE2_CAMERA_DIMENSION	FLOAT32
PGE2_CAMERA_QUAL	PGE2_DOWN_TRACK_DIMENSION, PGE2_CAMERA_DIMENSION	UINT8
PGE2_TEMP_TABLE	PGE2_DOWN_TRACK_DIMENSION, PGE2_TEMPERATURE_DIMENSION	FLOAT32
PGE2_TEMP_QUAL	PGE2_DOWN_TRACK_DIMENSION, PGE2_TEMPERATURE_DIMENSION	UINT8
PGE2_AUXILARY_TABLE	PGE2_DOWN_TRACK_DIMENSION, PGE2_AUXILARY_DIMENSION	INT32
PGE2_AUXILARY_QUAL	PGE2_DOWN_TRACK_DIMENSION, PGE2_AUXILARY_DIMENSION	UINT8
PGE2_TIME_TABLE	PGE2_TIME_DIMENSION, PGE2_TIME_ARRAY_DIMENSION	UINT8

Table 4-25 lists the data fields in the swath based on the location the data has been collected on the instrument. Each represents an SDS in the output MISR engineering file.

Table 4-25: Swath Data Fields for Engineering Data

Field Name	Description	Data Type	Valid Range
PGE2_time_table			
time_days	Time tag -first 16 bits of 64 bit time tag field representing days (array of 2 bytes)	FLOAT32	0 - 65536
time_msec1	Time tag - second 16 bits of 64 bit time tag field representing milliseconds (array of 2 bytes)	FLOAT32	0 - 65536
time_msec2	Time tag - third 16 bits of 64 bit time tag field representing milliseconds (array of 2 bytes)	FLOAT32	0 - 65536
time_micro	Time tag - fourth 16 bits of 64 bit time tag field representing microseconds (array of 2 bytes)	FLOAT32	0 - 1000
Packet_qual			
qual_indicator	Motor packet data quality indicator Quality values associated with each motor packet. Using bit-level triggers the quality flag is toggled as follows: Bit 0: Virtual data file could not be opened Bit 1: Header file could not be read Bit 2: Header packet count wrong Bit 3: Header spacecraft id wrong Bit 4: Header time stamp wrong Bit 7: Swath OK flag	UINT8	0 - 128
Swtich_values		UINT8	
cover_latched	Instrument cover latched	UINT8	0/1
n_cal_pnl_latched	North calibration panel latched	UINT8	0/1
s_cal_pnl_latched	South calibration panel latched	UINT8	0/1
cover_open	Instrument cover open	UINT8	0/1
cover_closed	Instrument cover closed	UINT8	0/1
n_cal_pnl_deploy	North calibration panel deployed	UINT8	0/1
n_cal_pnl_stowed	North calibration panel stowed	UINT8	0/1
s_cal_pnl_deploy	South calibration panel deployed	UINT8	0/1
s_cal_pnl_stowed	South calibration panel stowed	UINT8	0/1
repl_htr1	Replacement heater (1) indicator	UINT8	0/1

Table 4-25: Swath Data Fields for Engineering Data (Continued)

Field Name	Description	Data Type	Valid Range
repl_htr2;	Replacement heater (1) indicator	UINT8	0/1
MUX A data			
v1_ref_voltage	One volt reference voltage (V)	FLOAT32	0 to 6 volts
v5_ref_voltage	Five volt reference voltage (V)	FLOAT32	0 to 6 volts
goni_diode_temp	Temperature of goniometer PIN (deg C)	FLOAT32	-30 to +50 deg C
pin1_diode_temp	Temperature of PIN1 (deg C)	FLOAT32	-30 to +50 deg C
pin2_diode_temp	Temperature of PIN2 (deg C)	FLOAT32	-30 to +50 deg C
pin3_diode_temp	Temperature of PIN3 (deg C)	FLOAT32	-30 to +50 deg C
pin4_diode_temp	Temperature of PIN4 (deg C)	FLOAT32	-30 to +50 deg C
hqe_blue_green_temp	Temperature of blue (green) HQE (deg C)	FLOAT32	-30 to +50 deg C
red_nir_temp	Temperature of red (NIR) HQE (deg C)	FLOAT32	-30 to +50 deg C
cover_motor_temp	Motor cover temperature (deg C)	FLOAT32	-30 to +50 deg C
cal_pnl_motor_temp	South Cal Panel motor temperature (deg C)	FLOAT32	-30 to +50 deg C
opt_bench_temp	Optical bench control temperature (deg C)	FLOAT32	-30 to +50 deg C
pin2_blue_data	PIN2 blue current (na)	FLOAT32	0.8 to 48 na
pin2_green_data	PIN2 green current (na)	FLOAT32	0.8 to 48 na
pin2_red_data	PIN2 red current (na)	FLOAT32	0.8 to 48 na
pin2_NIR_data	PIN2 NIR current (na)	FLOAT32	0.8 to 48 na
MUX B data			
v1_ref_voltage	One volt reference voltage (V)	FLOAT32	0 to 6 volts
v5_ref_voltage	Five volt reference voltage (V)	FLOAT32	0 to 6 volts
power_sply_current	System power supply current (A)	FLOAT32	-0.0184 to 1.61 amp
cover_motor_current	Cover motor current (ma)	FLOAT32	0 to 2110 ma
goni_pin_blue_data	Goniometer PIN blue current (na)	FLOAT32	0.8 to 48 na
goni_pin_green_data	Goniometer PIN green current (na)	FLOAT32	0.8 to 48 na
goni_pin_red_data	Goniometer PIN red current (na)	FLOAT32	0.8 to 48 na
goni pin_NIR data	Goniometer PIN NIR current (na)	FLOAT32	0.8 to 48 na

Table 4-25: Swath Data Fields for Engineering Data (Continued)

Field Name	Description	Data Type	Valid Range
pin1_blue_data	PIN1 blue current (na)	FLOAT32	0.8 to 48 na
pin1_green_data	PIN1 green current (na)	FLOAT32	0.8 to 48 na
pin1_red_data	PIN1 red current (na)	FLOAT32	0.8 to 48 na
pin1_NIR_data	PIN1 NIR current (na)	FLOAT32	0.8 to 48 na
opt_bench_temp	Optical bench temperature (deg C)	FLOAT32	-30 to +50 deg C
goni_cover_mtr_temp	Goniometer cover motor temperature (deg C)	FLOAT32	-30 to +50 deg C
cal_pnl_motor_temp	North Cal Panel motor temperature (deg C)	FLOAT32	-30 to +50 deg C
volt_ref_temp	Voltage reference temperature (deg C)	FLOAT32	-30 to +50 deg C
MUX C data			
v1_ref_voltage	One volt reference voltage (V)	FLOAT32	0 to 6 volts
v5_ref_voltage	Five volt reference voltage (V)	FLOAT32	0 to 6 volts
goni_motor_current	Goniometer current (ma)	FLOAT32	0 to 2110 ma
tec_pos_x_temp	TECRAD+X temperature (deg C)	FLOAT32	-30 to +50 deg C
pin3_blue_data	PIN3 blue current (na)	FLOAT32	0.8 to 48 na
pin3_green_data	PIN3 green current (na)	FLOAT32	0.8 to 48 na
pin3_red_data	PIN3 red current (na)	FLOAT32	0.8 to 48 na
pin3_NIR_data	PIN3 NIR current (na)	FLOAT32	0.8 to 48 na
pin4_blue_data	PIN4 blue current (na)	FLOAT32	0.8 to 48 na
pin4_green_data	PIN4 green current (na)	FLOAT32	0.8 to 48 na
pin4_red_data	PIN4 red current (na)	FLOAT32	0.8 to 48 na
pin4_NIR_data	PIN4 NIR current (na)	FLOAT32	0.8 to 48 na
el_rad_neg_x_temp	Elec Rad -X temperature (deg C)	FLOAT32	-30 to +50 deg C
n_cal_pnl_temp	n_cal_pnl_temp	FLOAT32	-30 to +50 deg C
n_cal_pnl_temp	North Cal Panel temperature (deg C)	FLOAT32	-30 to +50 deg C
s_cal_pnl_temp	South Cal Panel temperature (deg C)	FLOAT32	-30 to +50 deg C
MUX D data			
v1_ref_voltage	One volt reference voltage (V)	FLOAT32	0 to 6 volts
v5_ref_voltage	Five volt reference voltage (V)	FLOAT32	0 to 6 volts
s_cal_pnl_motor_curr	South Cal Panel motor current (ma)	FLOAT32	0 to 2110 ma

Table 4-25: Swath Data Fields for Engineering Data (Continued)

Field Name	Description	Data Type	Valid Range
v5_logic_monitor	+5V logic monitor voltage (V)	FLOAT32	0 to 6 volts
v28_bus_monitor	+28V bus monitor voltage (V)	FLOAT32	0 to 55.44 volts
v11_bus_monitor	+11V bus monitor voltage (V)	FLOAT32	0 to 22.04 volts
dc_dc_converter_current	DC/DC converter current (A)	FLOAT32	-0.00876 to 2.77 amp
tec_volt_monitor	TEC monitor voltage (V)	FLOAT32	0 to 55.44 volts
hqe_blue_data	Goniometer position (deg)	FLOAT32	0.8 to 48 na
hqe_blue_data	North Cal Panel motor current (ma)	FLOAT32	0.8 to 48 na
hqe_blue_data	HQE blue current (na)	FLOAT32	0.8 to 48 na
hqe_green_data	HQE green current (na)	FLOAT32	0.8 to 48 na
hqe_red_data	HQE red current (na)	FLOAT32	0.8 to 48 na
hqe_nir_data	HQE NIR current (ma)	FLOAT32	0.8 to 48 na
Camera data (9 iterations)			
v1_ref_curr	One volt reference voltage (V)	FLOAT32	0 to 6 volts
v5_ref_curr	Five volt reference voltage (V)	FLOAT32	0 to 6 volts
ccd_fp_temp	CCD focal plane temperature (deg C)	FLOAT32	-30 to +50 deg C
optics_temp1	Optics 1 temperature (deg C)	FLOAT32	-30 to +50 deg C
optics_temp2	Optics 2temperature (deg C)	FLOAT32	-30 to +50 deg C
optics_temp3	Optics 3temperature (deg C)	FLOAT32	-30 to +50 deg C
optics_temp4	Optics 4temperature (deg C)	FLOAT32	-30 to +50 deg C
tec_hot_voltage_temp	TEC hot junction temperature (deg C)	FLOAT32	-30 to +50 deg C
v28_input_current	Input V28 current (ma)	FLOAT32	0 to 587 ma
cam_head_temp	Camera head temperature (deg C)	FLOAT32	-30 to +50 deg C
tec_cold_junc_temp	TEC cold junction temperature (deg C)	FLOAT32	-30 to +50 deg C
pwr_trans_q1_temp	Q1 temperature (deg C)	FLOAT32	-30 to +50 deg C
fp_heater_vltg	Focal plane heater voltage (V)	FLOAT32	-30 to +50 deg C
esc_vref_temp	ESC reference temperature (deg C)	FLOAT32	-30 to +50 deg C
hybrid_temp	Hybrid temperature (deg C)	FLOAT32	-30 to +50 deg C
Auxillary data			
NHK flag		UINT8	

Table 4-25: Swath Data Fields for Engineering Data (Continued)

Field Name	Description	Data Type	Valid Range
CAM flag		UINT8	
CMD flag		UINT8	
PGE2_packet_meta_table			
(Field definitions described Table 4-24)			

4.9.7 Per-swath QA Metadata

None.

4.10 MISR LEVEL 1A MI1A OBC ON-BOARD CALIBRATION DATA

4.10.1 File Metadata Description

None.

4.10.2 Per-swath Metadata Description

Table 4-26: Swath Metadata for OBC Data File

Swath Metadata	Definition	Data Type	Valid Values
PGE5_ORBIT_NO	Orbit counter	INT32	1-
PGE5_PATH_NO	Orbit path counter	INT32	1-233
PGE5_START_TIME	Calibration start time	FLOAT64	S/C time
PGE5_STOP_TIME	Calibration stop time	FLOAT64	S/C time
PGE5_NUM_OBC_SAMPLES	Number of OBC samples	INT32	
PGE5_SWATH_FLAGS	Quality flag for calibration	INT8	1-128
PGE5_OUT_OF_ORDER_PKTS	Listing of out of order packets found	INT16	(Array of 50)
PGE5_DUPLICATE_PKTS	Listing of duplicate packets found	INT16	(Array of 50)

4.10.3 Per-block Metadata Description

None.

4.10.4 Per-line Metadata Description

None.

4.10.5 Per-pixel (or -sample) Metadata Description

Table 4-27 describes the Per-sample Metadata that are specific to each data sample in a packet during the calibration sequence. For each data value in the diode and temperature SDSs there is a corresponding metadata value in a corresponding SDS.

Table 4-27: OBC Data Per-Sample Metadata

PerPacket Metadata	Definition	Data Type	Valid Range
Diode quality indicators	Quality values associated with each diode/ goniometer value collected. Using bit-level triggers the quality flag is toggled as follows: bit 0: Data extraction error bit 1: Data scaling error bit 2: Data byte alignment error bit 3: Data failed threshold check, high bit 4: Data failed threshold check, low bit 5: Unused bit 6: Unused bit 7: Data value is OK.	INT8	(Array of 26)
Temperate quality indicator	Quality values associated with each temperature value collected. Using bit-level triggers the quality flag is toggled as follows: bit 0: Data extraction error bit 1: Data scaling error bit 2: Data byte alignment error bit 3: Data failed threshold check, high bit 4: Data failed threshold check, low bit 5: Unused bit 6: Unused bit 7: Data value is OK.	INT8	(Array of 10)

4.10.6 Swath Data Set Descriptions

For MISR Calibration processing the data collected during any of the types of calibration sequence modes generates On-board calibration data which is stored in an output MISR OBC swath file. Data quality checks are performed on all radiometry, temperatures and time tags in the packets.

Table 4-28: OBC Data Dimension Descriptions

Dimension	Description	Valid Values
PGE5_TIME_DIMENSION	Unlimited, time tag for each engineering packet collected	0 -
PGE5_TIME_ARRAY_DIMENSION	Number of bytes in a engineering/navigation packet time tag	8
PGE5_DOWN_TRACK_DIMENSION	Unlimited, number of OBC samples retrieved during a calibration sequence	0 -
PGE5_RAD_DIMENSION	Radiometry values retrieved during a calibration sequence	26

Table 4-28: OBC Data Dimension Descriptions (Continued)

Dimension	Description	Valid Values
PGE5_TEMPERATURE_DIMENSION	Diode temperature readings retrieved during a calibration sequence	8

Table 4-29: OBC Data Swath Field Definitions

Field Name Parameter Description	Dimension List	Number Type
Swath OBCSwath		
PGE5_PACKET_QUAL	PGE5_DOWN_TRACK_DIMENSION	UINT32
PGE5_RAD_TABLE	PGE5_DOWN_TRACK_DIMENSION, PGE5_RAD_DIMENSION	FLOAT32
PGE5_RAD_QUAL	PGE5_DOWN_TRACK_DIMENSION, PGE3_RAD_DIMENSION	UINT8
PGE5_TEMP_TABLE	PGE5_DOWN_TRACK_DIMENSION, PGE5_TEMPERATURE_DIMENSION	FLOAT32
PGE5_TEMP_QUAL	PGE5_DOWN_TRACK_DIMENSION, PGE5_TEMPERATURE_DIMENSION	UINT8
PGE5_PKT_TIME_TABLE	PGE5_TIME_DIMENSION, PGE5_TIME_ARRAY_DIMENSION	FLOAT32
PGE5_DIODE_TIME_TABLE	PGE5_TIME_DIMENSION, PGE5_TIME_ARRAY_DIMENSION	FLOAT32

Table 4-30 lists the data fields in the swath based on the location the data has been collected on the instrument. Each represents an SDS in the output MISR on-board calibration file.

Table 4-30: Swath Data Fields for Level 1A OBC Data

Field Name	Description	Data Type	Valid Range
Packet_time			
time_days	Time tag -first 16 bits of 64 bit time tag field representing days (array of 2 bytes)	FLOAT32	0 - 65536
time_msec1	Time tag - second 16 bits of 64 bit time tag field representing milliseconds (array of 2 bytes)	FLOAT32	0 - 65536



Table 4-30: Swath Data Fields for Level 1A OBC Data (Continued)

Field Name	Description	Data Type	Valid Range
time_msec2	Time tag - third 16 bits of 64 bit time tag field representing milliseconds (array of 2 bytes)	FLOAT32	0 - 65536
time_micro	Time tag - fourth 16 bits of 64 bit time tag field representing microseconds (array of 2 bytes)	FLOAT32	0 - 1000
Temperatures			
Goniometer PIN-diodes temperature	Temperature reading, goniometer PIN diode	FLOAT32	-30 to +50 deg C
#1 PIN-diodes temperature	Temperature reading, #1 PIN diode	FLOAT32	-30 to +50 deg C
#2 PIN-diodes temperature	Temperature reading, #2 PIN diode	FLOAT32	-30 to +50 deg C
#3 PIN-diodes temperature	Temperature reading, #3 PIN diode	FLOAT32	-30 to +50 deg C
#4 PIN-diodes temperature	Temperature reading, #4 PIN diode	FLOAT32	-30 to +50 deg C
Blue-Green HQE diode temperature	Temperature reading, Blue or Green HQE diode	FLOAT32	-30 to +50 deg C
Red-NIR HQE diode temperature	Temperature reading, Red or Near-IR HQE diode	FLOAT32	-30 to +50 deg C
Goniometer motor temperature	Temperature reading, goniometer motor	FLOAT32	-30 to +50 deg C
Temperature_qual			
qual_indicator	<p>Quality values associated with each radiometry value. Using bit-level triggers the quality flag is toggled as follows:</p> <p>bit 0: The data could not be extracted from the raw packet bit 1: The data could not be scaled properly bit 2: The data could not be byte aligned properly bit 3: The value failed the threshold check high bit 4: The value failed the threshold check low bit 7: The value is OK.</p>	UINT8	0 - 128
Diode_time (per diode sample)			
time_days	Time tag -first 16 bits of 64 bit time tag field representing days (array of 2 bytes)	FLOAT32	0 - 65536



Table 4-30: Swath Data Fields for Level 1A OBC Data (Continued)

Field Name	Description	Data Type	Valid Range
time_msec1	Time tag - second 16 bits of 64 bit time tag field representing milliseconds (array of 2 bytes)	FLOAT32	0 - 65536
time_msec2	Time tag - third 16 bits of 64 bit time tag field representing milliseconds (array of 2 bytes)	FLOAT32	0 - 65536
time_micro	Time tag - fourth 16 bits of 64 bit time tag field representing microseconds (array of 2 bytes)	FLOAT32	0 - 1000
Radiometry			
#1 PIN diode (all four bands)	Diode data, #1 PIN diode	FLOAT32	0.8 to 48 na
#2 PIN diode (all four bands)	Diode data, #2 PIN diode	FLOAT32	0.8 to 48 na
#3 PIN diode (all four bands)	Diode data, #3 PIN diode	FLOAT32	0.8 to 48 na
#4 PIN diode (all four bands)	Diode data, #4 PIN diode	FLOAT32	0.8 to 48 na
HQE diode (all four bands)	HQE diode data	FLOAT32	0.8 to 48 na
Goniometer potentiometer voltage	Goniometer potentiometer voltage	FLOAT32	-64.9 to 64.9 deg
Goniometer motor current	Goniometer motor current	FLOAT32	0 to 2110 ma
Radiometry_qual			
qual_indicator	<p>Quality values associated with each radiometry value. Using bit-level triggers the quality flag is toggled as follows:</p> <p>bit 0: The data could not be extracted from the raw packet bit 1: The data could not be scaled properly bit 2: The data could not be byte aligned properly bit 3: The value failed the threshold check high bit 4: The value failed the threshold check low bit 5: The value failed the root sum square check bit 6: The value failed the standard deviation check bit 7: The value is OK.</p>	UINT8	0 - 128



4.10.7 Per-swath QA Metadata

None.



5.0 MISR LEVEL 1B1 RADIOMETRIC PRODUCT

5.1 MISR LEVEL 1B1 PRODUCT GRANULE NAMES

MISR Level 1B1 Radiometric Data Products are composed of the file granules listed below (Table 5-1).

Table 5-1: MISR Level 1B1 File Granule Names

MISR LEVEL 1B1 FILE GRANULE NAME	ESDT Name	Section
MISR_AM1_RP_GM_Pmmm_Onnnnnn_cc_Fff_vvvv.hdf	MI1B1	5.4
MISR_AM1_RP_LM_Pmmm_Onnnnnn_cc_SITE_<string>_Fff_vvvv.hdf	M1B1LM	see above

5.2 MISR LEVEL 1B1 PRODUCT GRANULE BRIEF DESCRIPTIONS

MISR Level 1B1 (MI1B1) Radiometric Product contains the global mode radiances for an entire swath. The Level 1B1 Local Mode (M1B1LM) Radiometric product is identical in format to the global mode product; however, it contains a small subset of the swath acquired when the instrument was in Local Mode. Local Mode products are not generated for all swaths.

During radiance scaling and conditioning the instrument DN values are converted to spectral radiances and reported in MKS (meter, kilogram, second) units referred to as SI (Système International). Use is made of the camera calibration data, where the response of the system to a known radiance field is quantized. These data represent our best estimate of instrument response, as determined through many different activities conducted both preflight and in-flight. For further details, please refer to section [9.2.4] of the Ancillary Products description.

It is noted that MISR does not provide a radiometric product scaled to the exo-atmospheric solar irradiance. As MISR does not view the Sun directly, such a data set could only be obtained by employing a solar model, and would be of no greater accuracy than the radiance product.

5.3 MISR LEVEL 1B1 PRODUCT GRANULE DATA SETS

The L1B1 products will be produced as two ESDTs, as shown in Table 5-2. Each physical file is in the HDF-EOS Swath format and each contains four Swath datasets corresponding to the four bands

of a MISR camera

Table 5-2: Level 1B1 Radiometric Product File and Swath Datasets

ESDT Short-name	Local Granule ID^a	Swath Dataset Name
M1B1	MISR_AM1_RP_GM_Pmmm_Onnnnnn_cc_Fff_vvvv.hdf	L1B1_Blue_Product
		L1B1_Green_Product
		L1B1_Red_Product
		L1B1_Nir_Product
M1B1LM	MISR_AM1_RP_LM_Pmmm_Onnnnnn_cc_SITE_<string>_Fff_vvvv.hdf	same 4 bands as above

a. Where Pmmm corresponds to the orbit path number, Onnnnnn is the absolute orbit number, cc is the camera identifier, ff is the format version number and vvvv is the file version number.

5.4 MISR LEVEL 1B1 MI1B1 RADIOMETRIC PRODUCT

5.4.1 File Metadata Description.

Table 5-3: Metadata for Radiometric Product Files

Swath Metadata	Definition	Data Type	Valid Values
PathNumber	Orbital path number	INT32	1-233
OrbitNumber	Orbit Number	INT32	1-99,999
Camera	Camera identifier	UINT8	1-9
CameraMode	Camera mode identifier	UINT8	0 = Local Mode 1 = Global Mode
NumLMEvents	Number of Local Mode Acquisitions which occurred during this orbit, regardless of Camera_mode.	INT8	0-6
LMSiteName	The geographical name of the local mode site, if this is a local mode file.	CHAR8	string up to 12 characters, including null.
StartTime	Start time reported in Detailed Activity Schedule	CHAR8	UTC string in CCSDS ASCII Time Code A
StopTime	Stop time reported in Detailed Activity Schedule	CHAR8	UTC string in CCSDS ASCII Time Code A
PGStartOffset	Time in seconds past DAS_start_time at which to begin PGE processing.	FLOAT64	0.0 - 98.88 min.
PGStopOffset	Time in seconds since DAS_start_time at which to end PGE processing. (Preempted if DAS_stop_time earlier.)	FLOAT64	0.0 - 98.88 min.
PGStartTAI	Actual time of first L1B1 line processed. TAI is PGS Toolkit internal time, which is the real number of continuous seconds since UTC 12 am 1-1-1993.	FLOAT64	

5.4.2 Per-swath Metadata Description

For the Radiometric Product, Swath attributes are attached using HDF-EOS calls of the Swath

application (Table 5-4).

Table 5-4: Swath Metadata for Radiometric Product Files

Swath Metadata	Definition	Data Type	Valid Values
Rad_scale_factor	Multiplicative Radiometric scale factor to convert stored integer data values to floating point values in SI units.	FLOAT64	
Line_average_mode	Line Average Mode	UINT8	1 = 275 m 4=1.1 km
Sample_average_mode	Sample Average Mode	UINT8	1 = 275 m 4=1.1 km
Number_Lines_in_Data_Array	Length of HDF-EOS swath array.	INT32	0-100,000
Last_Valid_Data_Line	Last line in this HDF-EOS swath array which actually contains MISR data.	INT32	0-100,000
GM_Line_Where_LM_Begins	In Local Mode products, this field indicates the equivalent line number in the global mode swath of the first local mode line.	INT32	0-100,000
GM_Line_Where_LM_Ends	In Local Mode products, this field indicates the equivalent line number in the global mode swath of the last local mode line.	INT32	0-100,000

5.4.3 Per-line Metadata Description

5.4.3.1 A scene background correction algorithm is under consideration for use in the MISR Level 1B1 software. This algorithm would remove image ghosts from the MISR radiances. Low-intensity ghosting is caused by stray light which can be scattered within the MISR optics. Normally, these artifacts are of negligible brightness. However, in scenes which exhibit very high contrast, this

ghosting can introduce a significant radiometric error in some portions of the scene. In order to allow users to reverse this correction, if desired, the Scene Average Radiance for each line is reported in the radiance product. **NOTE: At this time, the background correction algorithm is not being applied to MISR data.**

Table 5-5: Per-line Scene Average for Background Correction

Field Name	Definition	Data Type
L1B1_Line_Scene_Average_Blue	The average radiance value of the 2-D scene centered on the line in question. The scene is defined as a window of 101 lines, 50 above the current line and 50 below it. If the instrument is in 4x4 mode, then the scene is composed of 25 lines, instead. The full active swath width is used in both modes. Scenes are averaged separately by band.	FLOAT32
L1B1_Line_Scene_Average_Green		FLOAT32
L1B1_Line_Scene_Average_Red		FLOAT32
L1B1_Line_Scene_Average_Nir		FLOAT32

5.4.4 Per-pixel Metadata Description

None.

5.4.5 Swath Data Set Descriptions

5.4.5.1 Field dimension and Spatial Resolution descriptions

Table 5-6: Radiometric Product Field Dimension Descriptions

Dimension	Description	Valid Values
Sample	<i>Sample</i> is the width of the swath in pixels.	1504 for 275 m parameters 376 for 1.1 km parameters
Line	<i>Line</i> is the length of the swath in pixels.	Depends on acquisition length

For the Radiometric Product files, the spatial resolution (and therefore the XDim and YDim) of the different Swaths within the file depend on the averaging mode that band is in for that particular camera. For the nominal Global Mode called “Super Stereo”, the following table relates the spatial resolution to camera and band.

Table 5-7: Spatial Resolution Distribution for Global mode

Grid	DF	CF	BF	AF	AN	AA	BA	CA	DA
NIRBand	1.1 km x 1.1 km	1.1 km x 1.1 km	1.1 km x 1.1 km	1.1 km x 1.1 km	275 m x 275 m	1.1 km x 1.1 km	1.1 km x 1.1 km	1.1 km x 1.1 km	1.1 km x 1.1 km

Table 5-7: Spatial Resolution Distribution for Global mode (Continued)

Grid	DF	CF	BF	AF	AN	AA	BA	CA	DA
RedBand	275 m x 275 m	275 m x 275 m	275 m x 275 m	275 m x 275 m	275 m x 275 m	275 m x 275 m	275 m x 275 m	275 m x 275 m	275 m x 275 m
BlueBand	1.1 km x 1.1 km	1.1 km x 1.1 km	1.1 km x 1.1 km	1.1 km x 1.1 km	275 m x 275 m	1.1 km x 1.1 km	1.1 km x 1.1 km	1.1 km x 1.1 km	1.1 km x 1.1 km
GreenBand	1.1 km x 1.1 km	1.1 km x 1.1 km	1.1 km x 1.1 km	1.1 km x 1.1 km	275 m x 275 m	1.1 km x 1.1 km	1.1 km x 1.1 km	1.1 km x 1.1 km	1.1 km x 1.1 km

In Local mode, all channels are reported at 275 meter resolution as described in table [5-8].

Table 5-8: Spatial Resolution Distribution for Local mode

Grid	DF	CF	BF	AF	AN	AA	BA	CA	DA
NIRBand	275 m x 275 m	275 m x 275 m	275 m x 275 m	275 m x 275 m	275 m x 275 m	275 m x 275 m	275 m x 275 m	275 m x 275 m	275 m x 275 m
RedBand	275 m x 275 m	275 m x 275 m	275 m x 275 m	275 m x 275 m	275 m x 275 m	275 m x 275 m	275 m x 275 m	275 m x 275 m	275 m x 275 m
BlueBand	275 m x 275 m	275 m x 275 m	275 m x 275 m	275 m x 275 m	275 m x 275 m	275 m x 275 m	275 m x 275 m	275 m x 275 m	275 m x 275 m
GreenBand	275 m x 275 m	275 m x 275 m	275 m x 275 m	275 m x 275 m	275 m x 275 m	275 m x 275 m	275 m x 275 m	275 m x 275 m	275 m x 275 m

The following are flag values used for each parameter. In addition to radiances, the Level 1B1 product files also contain Data Quality Indicator and Time structures as seen in table [5-10].:

Table 5-9: Radiometric Product Parameter Fill Values

L1B1_DQI_[Blue,Green,Red,Nir]	L1B1_Scaled_Rad_[Blue,Green,Red,Nir]	L1B1_Line_TAI_Time_[Blue,Green,Red,Nir]
0 = Within specifications 1 = Reduced accuracy 2 = Not usable for science 3 = Unusable for any purpose	16377 = Gap fill 16378 = Negative discriminant 16379 = Radiance out of range 16380 = Negative radiance	TAI is PGS Toolkit internal time, which is the real number of continuous seconds since UTC 12 am 1-1-1993. -999 = Gap fill

Note: Radiance values are scaled integers in the product file. In order to convert to floating point radiances in the units specified below, multiply Rad_scale_factor (from the Swath Metadata, Table

5-4) by the scaled integer.

Table 5-10: Radiometric Product Parameters Swath Field Definitions

Field Name Parameter Description	Dimension List	Number Type	Units	Transformation	Flag Values
Swath L1B1_Blue_Product (Spatial Resolution: varies, see above)					
L1B1_Scaled_Rad_Blue	Sample,Line	INT16	$W m^{-2} sr^{-1}$ μm^{-1} (scaled)	See note above.	see table [5-9]
L1B1_DQI_Blue	Sample,Line	UINT8			see table [5-9]
L1B1_Line_TAI_Time_Blue	Line	FLOAT64			see table [5-9]
Swath L1B1_Green_Product (Spatial Resolution: 275 m x 275 m)					
L1B1_Scaled_Rad_Green	Sample,Line	INT16	$W m^{-2} sr^{-1}$ μm^{-1} (scaled)	See note above.	see table [5-9]
L1B1_DQI_Green	Sample,Line	UINT8			see table [5-9]
L1B1_Line_TAI_Time_Green	Line	FLOAT64			see table [5-9]
Swath L1B1_Red_Product (Spatial Resolution: varies, see above)					
L1B1_Scaled_Rad_Red	Sample,Line	INT16	$W m^{-2} sr^{-1}$ μm^{-1} (scaled)	See note above.	see table [5-9]
L1B1_DQI_Red	Sample,Line	UINT8			see table [5-9]
L1B1_Line_TAI_Time_Red	Line	FLOAT64			see table [5-9]
Swath L1B1_Nir_Product (Spatial Resolution: varies, see above)					
L1B1_Scaled_Rad_Nir	Sample,Line	INT16	$W m^{-2} sr^{-1}$ μm^{-1} (scaled)	See note above.	see table [5-9]
L1B1_DQI_Nir	Sample,Line	UINT8			see table [5-9]
L1B1_Line_TAI_Time_Nir	Line	FLOAT64			see table [5-9]

5.4.6 Radiometric Product QA Metadata

Additional Quality Assessment Metadata is no longer reported in HDF-EOS vdata structures nor in a separate QA statistics file.



6.0 MISR LEVEL 1B2 GEORECTIFIED RADIANCE PRODUCT

6.1 MISR LEVEL 1B2 PRODUCT GRANULE NAMES

MISR Level1B2 Georectified Radiance Products are composed of the six file granules listed below (Table 6-1), plus the browse product, which is a JPEG image of the Ellipsoid product. Two additional intermediate granules, the ellipsoid and terrain transform parameters products (TRP), are described for the sake of completeness; but they may not be available for distribution.

Table 6-1: MISR Level 1B2 File Granule Names

MISR LEVEL 1B2 FILE GRANULE NAME	ESDT Name	Section
MISR_AM1_GRP_ELLIPSOID_GM_Pmmm_Onnnnnn_cc_Fff_vvvv.hdf	MI1B2E	§6.4
MISR_AM1_GRP_ELLIPSOID_LM_Pmmm_Onnnnnn_cc_Fff_vvvv.hdf	MB2LME	§6.4
MISR_AM1_GRP_TERRAIN_GM_Pmmm_Onnnnnn_cc_Fff_vvvv.hdf	MI1B2T	§6.5
MISR_AM1_GRP_TERRAIN_LM_Pmmm_Onnnnnn_cc_Fff_vvvv.hdf	MB2LMT	§6.5
MISR_AM1_GP_GMP_Pmmm_Onnnnnn_Fff_vvvv.hdf	MIB2GEOP	§6.6
MISR_AM1_GRP_RCCM_GM_Pmmm_Onnnnnn_cc_Fff_vvvv.hdf	MIRCCM	§6.7
MISR_AM1_GRP_ELLIPSOID_GM_BR_Pmmm_Onnnnnn_cc_Fff_vvvv.jpg	MISBR	§6.8
MISR_AM1_TRP_ELLIPSOID_Pmmm_Onnnnnn_cc_Fff_vvvv.hdf	MIB2TRPE	§6.9
MISR_AM1_TRP_TERRAIN_Pmmm_Onnnnnn_cc_Fff_vvvv.hdf	MIB2TRPT	§6.10

6.2 MISR LEVEL 1B2 GEORECTIFIED RADIANCE PRODUCT GRANULE BRIEF DESCRIPTIONS

The Level 1B2 Georectified Radiance Product (GRP) consists of six parameter sets with certain kinds of geometric corrections and have been projected to a Space-Oblique Mercator (SOM) map grid. First, the ellipsoid-projected TOA radiance global mode (GM) parameter uses supplied spacecraft position and pointing and is not corrected for topography, but is resampled to the reference ellipsoid. This global mode parameter is averaged onboard the spacecraft to 1.1 km x 1.1 km resolution in the off-nadir, non-red-band channels. Second, over specific targets, called local mode sites, the ellipsoid-projected local mode (LM) TOA radiance is reported at 275 m x 275 m resolution in all channels. Third, the terrain-projected TOA radiance global mode parameter has had a geometric correction applied which removes the errors of spacecraft position and pointing knowledge and errors due to topography. The parameter is then ortho-rectified on a reference ellipsoid at the surface. This global mode parameter is averaged to 1.1 km x 1.1 km resolution in the off-nadir, non-red-band channels. Fourth, over specific targets, called local mode sites, the terrain-projected local mode (LM) TOA radiance is reported at 275 m x 275 m resolution in all channels. The parameters defined so far also carry a Radiometric Data Quality Indicator (RDQI) associated with each measurement. Fifth, there are the geometric parameters which measure the sun and view angles at

the reference ellipsoid.

Retrieval of aerosol and surface properties within MISR Aerosol/Surface SDP processing requires the absence of clouds in order that the assumptions inherent in the retrievals are not invalidated. Thus, one more parameter is part of this product: the radiometric camera-by-camera cloud mask (RCCM). It is used for several purposes during MISR geophysical parameter retrievals within the TOA/Cloud Product processing. A data quality flag and a glitter mask are also carried for this parameter.

6.3 MISR LEVEL 1B2 GEORECTIFIED RADIANCE PRODUCT GRANULE DATA SETS

The Georectified Radiance Product will be produced as six separate ESDTs, each with one physical file (Table 6-2). Each physical file is in the HDF-EOS Grid “stacked-block” format and each contains one or more HDF-EOS Grid datasets, corresponding to parameters at certain spatial resolutions. The grid datasets will have the usual x and y dimensions, as well as a third dimension corresponding to the SOM block number. The x and y dimensions will correspond to the number of samples in the along-track and cross-track directions, respectively. The blocks that make up the Georectified Radiance Product files are identical to the blocks that make up the Ancillary Geographic Product.

Table 6-2: Level 1B2 Georectified Radiance Product Files and Grid Datasets

ESDT Shortname	Local Granule ID ^a	Grid Dataset Name
MI1B2E	MISR_AM1_GRP_ELLIPSOID_GM_Pmmm_Onnnnnn_cc_Fff_vv vv.hdf	NIRBand
		RedBand
		GreenBand
		BlueBand
MB2LME	MISR_AM1_GRP_ELLIPSOID_LM_Pmmm_Onnnnnn_cc_Fff_vv vv.hdf	NIRBand
		RedBand
		GreenBand
		BlueBand
MI1B2T	MISR_AM1_GRP_TERRAIN_GM_Pmmm_Onnnnnn_cc_Fff_vv v.hdf	NIRBand
		RedBand
		GreenBand
		BlueBand

Table 6-2: Level 1B2 Georectified Radiance Product Files and Grid Datasets

ESDT Shortname	Local Granule ID^a	Grid Dataset Name
MB2LMT	MISR_AM1_GRP_TERRAIN_LM_Pmmm_Onnnnnn_cc_Fff_vvvv.hdf	NIRBand
		RedBand
		GreenBand
		BlueBand
MIB2GEOP	MISR_AM1_GP_GMP_Pmmm_Onnnnnn_Fff_vvvv.hdf	Geometric Parameters
MIRCCM	MISR_AM1_GRP_RCCM_GM_Pmmm_Onnnnnn_cc_Fff_vvvv.hdf	RCCM

a. Where Pmmm corresponds to the orbit path number, Onnnnnn is the absolute orbit number, cc is the camera identifier, ff is the file format version and vvvv is the version number (which relates to the reprocessing of a dataset with different software and/or ancillary inputs).

6.4 MISR LEVEL 1B2 MI1B2E AND MB2LME ELLIPSOID-PROJECTED PRODUCTS

6.4.1 File Metadata Description

Table 6-3: File Metadata for Ellipsoid-projected TOA Radiance Files.

File Metadata Field Name	Definition	Data Type	Units	Valid Range
Path_number	Orbit path number	INT32	N/A	1-233
AGP_version_id	Version Identifier for Ancillary Geographic Product	INT32	N/A	2

File Metadata Field Name	Definition	Data Type	Units	Valid Range
DID_version_id	Version Identifier for DID (DTED [Digital Terrain Elevation Dataset] Intermediate Dataset)	INT32	N/A	4
Number_blocks	Total number of blocks	INT32	N/A	1-180
Ocean_blocks_size	Ocean_blocks.number dimension	INT32	N/A	1-180
Ocean_blocks.count	Total number of blocks containing entirely ocean radiances	INT32	N/A	1-180
Ocean_blocks.numbers	List of block numbers containing entirely ocean radiances	INT32	N/A	1-180
SOM_parameters.som_ellipsoid.a	Semimajor axis of ellipsoid	FLOAT64	meters	WGS84
SOM_parameters.som_ellipsoid.e2	Eccentricity of ellipsoid squared	FLOAT64	N/A	WGS84
SOM_parameters.som_orbit.aprime	Semimajor axis of orbit	FLOAT64	meters	Not Used
SOM_parameters.som_orbit.eprime	Eccentricity of orbit	FLOAT64	N/A	Not Used
SOM_parameters.som_orbit.gama	Longitude of perigee	FLOAT64	radians	Not Used
SOM_parameters.som_orbit.nrev	Number of revolutions	INT32	N/A	233
SOM_parameters.som_orbit.ro	Radius of circular orbit	FLOAT64	meters	7078040.8
SOM_parameters.som_orbit.i	Inclination of orbit	FLOAT64	radians	1.7157253
SOM_parameters.som_orbit.P2P1	Ratio of time of revolution over length of Earth rotation/orbit	FLOAT64	N/A	0.0068666667
SOM_parameters.som_orbit.lambda0	Geodetic longitude of ascending node at time 0	FLOAT64	radians	0 - 2Pi
Origin_block.ulc.x	SOM X coordinate (in meters) of the upper left corner of the first block	FLOAT64	meters	6 million to 33 million
Origin_block.ulc.y	SOM Y coordinate (in meters) of the upper left corner of the first block	FLOAT64	meters	+/- 12 million
Origin_block.lrc.x	SOM X coordinate (in meters) of the lower right corner of the first block	FLOAT64	meters	6 million to 33 million
Origin_block.lrc.y	SOM Y coordinate (in meters) of the lower right corner of the first block	FLOAT64	meters	+/- 12 million

File Metadata Field Name	Definition	Data Type	Units	Valid Range
Start_block	The block number in the AGP which corresponds to the first block in this file containing data.	INT32	N/A	1 - 180 Start_block < End block
End_block	The block number in the AGP which corresponds to the last block in this file containing data.	INT32	N/A	1 - 180 Start_block < End block
Cam_mode	Indicates whether the data in this grid file were obtained in MISR global mode or local mode.	INT32	N/A	0-1 1 = global 0 = local
Num_local_modes	The number of MISR local mode acquisitions contained in this file.	INT32	N/A	0-1 0 if data is global mode
Local_mode_site_name	The geographical name of the local mode site contained in this file for local mode files; null string for global mode files.	CHAR8	N/A	string up to 12 characters in length, including null
Orbit_QA	Indication of the overall quality of the orbit data based on analysis of quality flags in the spacecraft attitude and ephemeris data. Geolocation accuracy may be impaired for orbits with poor quality orbit data.	FLOAT32	N/A	-9999.0 = NoRetrieval, -1.0 = Poor, 0.0 = Nominal
Camera	Indicator of MISR camera	INT32	N/A	Df = 1 Cf = 2 Bf = 3 Af = 4 An = 5 Aa = 6 Ba = 7 Ca = 8 Da = 9

6.4.2 Per-grid Metadata Description

Table 6-4: Per-grid Metadata for Ellipsoid-projected TOA Radiance Grids.

Common Grid Metadata	Definition	Data Type	Valid Values
Block_size.resolution_x	Resolution of block x dimension in meters	INT32	275, 1100
Block_size.resolution_y	Resolution of block y dimension in meters	INT32	275, 1100
Block_size.size_x	Block x dimension	INT32	512, 128
Block_size.size_y	Block y dimension	INT32	2048, 512

Table 6-5: Per-grid Metadata for Ellipsoid-projected TOA Radiance Grids.

Radiance Grid Metadata	Definition	Data Type	Valid Values
Scale factor	Multiplicative scale factor for converting the stored 14-bit number to radiance in units $W m^{-2} sr^{-1} \mu m^{-1}$	FLOAT64	<1
std_solar_wgtd_height	$E_0^{std}(b)$ [$W m^{-2} \mu m^{-1}$], solar irradiances, standardized response weighted	FLOAT32	
SunDistanceAU	Approximate distance in astronomical units between the center of the earth and the center of the sun at the time MISR observes the first valid (non-fill) pixel in the swath. Replicated across bands for convenience; does not vary with band.	FLOAT64	

Table 6-6: Per-grid Metadata for Geometric Parameters and BRF Conversion Factors Grids.

Common Grid Metadata	Definition	Data Type	Valid Values
Block_size.resolution_x	Resolution of block x dimension in meters	INT32	17600
Block_size.resolution_y	Resolution of block y dimension in meters	INT32	17600
Block_size.size_x	Block x dimension	INT32	8
Block_size.size_y	Block y dimension	INT32	32

6.4.3 Per-block Metadata Description

Table 6-7: PerBlock Metadata for Ellipsoid-projected TOA Radiance File.

PerBlockMetadataCommon	Definition	Data Type	Valid Range
Block_number	Block number with respect to the Ancillary Geographic Product	INT32	1-180
Ocean_flag	Flag signalling whether the block contains entirely ocean radiances	INT8	0 = block has no ocean or is a mix of ocean and land 1 = block is entirely ocean
Block_coor_ulc_som_meter.x	Upper left corner SOM block x coordinate in meters	FLOAT64	
Block_coor_ulc_som_meter.y	Upper left corner SOM block y coordinate in meters	FLOAT64	
Block_coor_lrc_som_meter.x	Lower right corner SOM block x coordinate in meters	FLOAT64	
Block_coor_lrc_som_meter.y	Lower right corner SOM block y coordinate in meters	FLOAT64	
Data_flag	Flag signalling whether the block contains entirely fill data	INT8	0 = block contains entirely fill data 1 = block contains valid data

PerBlockMetadataRad	Definition	Data Type	Valid Range
number_transform	Number of transforms required for the block. If this number is two, then the following records occur twice.	INT32	Terrain: always 0 Ellipsoid: 0, 1, or 2
transform.ref_time	The time at which line 0 was acquired by the camera, adjusted for instrument corrections to this block.	CHAR8 * 54	
transform.start_line	Defines the starting SOM boundary for which this transform applies relative to the first block in the entire swath.	INT32	

PerBlockMetadataRad	Definition	Data Type	Valid Range
transform.number_line	Defines the ending SOM boundary for which this transform applies.	INT32	
transform.coeff_line[6]	The vector describing the line transform coefficients.	FLOAT64 * 6	
transform.coeff_samp[6]	The vector describing the sample transform coefficients.	FLOAT64 * 6	
transform.som_ctr.x	The x SOM coordinate of the center of the transform area, used in applying the transform.	FLOAT64	
transform.som_ctr.y	The y SOM coordinate of the center of the transform area, used in applying the transform.	FLOAT64	
transform.ipi_adj_sum		FLOAT64	
GDQI	Geometric Data Quality Indicator	FLOAT64	Terrain: -1.0 - 1.0 Ellipsoid: always 0.0

PerBlockMetadataTime	Definition	Data Type	Valid Range
BlockCenterTime	TAI time of the lower right pixel of the center four pixels in the current block, converted to UTC time, and displayed in CCSDS ASCII time code A format. Note: BlockCenterTime may be incorrect for the first and last blocks processed in a swath.	CHAR8 * 28	

6.4.4 Per-line Metadata Description

None.

6.4.5 Per-pixel Metadata Description

None.

6.4.6 Grid Data Set Descriptions

Table 6-8: Ellipsoid-projected Grid Data Set Descriptions.

Dimension	Description	Valid Values
SOMBlockDim	<i>SOMBlockDim</i> is the number of SOM blocks in the file. The slowest-varying dimension is implicitly the SOM block dimension. It is not shown in the tables below.	180
XDim	<i>XDim</i> is the number of lines in a block. The x dimension direction is identical to the standard SOM x dimension.	512 for 275 m parameters 128 for 1.1 km parameters 8 for 17.6 km parameters
YDim	<i>YDim</i> is the number of samples in a block. The y dimension direction is identical to the standard SOM y dimension.	2048 for 275 m parameters 512 for 1.1 km parameters 32 for 17.6 km parameters

For the Terrain-projected TOA Radiance and the Ellipsoid-projected TOA Radiance files, the spatial resolution (and therefore the XDim and YDim) of the different Grids within the file depend on the averaging mode that band is in for that particular camera. For local mode the spatial resolution is 275 m x 275 m for all cameras and bands. For the nominal Global Mode , the following table relates the spatial resolution to camera and band.

Table 6-9: Spatial Resolution Distribution for Global mode

Grid	DF	CF	BF	AF	AN	AA	BA	CA	DA
NIRBand	1.1 km x 1.1 km	1.1 km x 1.1 km	1.1 km x 1.1 km	1.1 km x 1.1 km	275 m x 275 m	1.1 km x 1.1 km	1.1 km x 1.1 km	1.1 km x 1.1 km	1.1 km x 1.1 km
RedBand	275 m x 275 m	275 m x 275 m	275 m x 275 m	275 m x 275 m	275 m x 275 m	275 m x 275 m	275 m x 275 m	275 m x 275 m	275 m x 275 m
BlueBand	1.1 km x 1.1 km	1.1 km x 1.1 km	1.1 km x 1.1 km	1.1 km x 1.1 km	275 m x 275 m	1.1 km x 1.1 km	1.1 km x 1.1 km	1.1 km x 1.1 km	1.1 km x 1.1 km
GreenBand	1.1 km x 1.1 km	1.1 km x 1.1 km	1.1 km x 1.1 km	1.1 km x 1.1 km	275 m x 275 m	1.1 km x 1.1 km	1.1 km x 1.1 km	1.1 km x 1.1 km	1.1 km x 1.1 km

The following are flag values used for each parameter:

Table 6-10: Ellipsoid-projected TOA Radiance Parameter Fill Values

RDQI	Radiance
0 = Within specifications 1 = Reduced accuracy 2 = Not usable for science 3 = Unusable for any purpose	16378 = SOM location not seen by the camera, i.e., this will occur outside the swath edges and at the top and bottom of the swath 16380 = Radiance unusable due to high RDQIs

The following are the parameters that make up the file:

Table 6-11: Ellipsoid-projected Parameters Grid Field Definitions

Field Name Parameter Description	Dimension List	Number Type	Units	Transformation	Flag Values
Grid NIRBand (Spatial Resolution: varies, see above)					
NIR Radiance/RDQI	XDim, YDim	UINT16	Radiance: $W m^{-2} sr^{-1}$ μm^{-1} (scaled) RDQI: none	Bit packed: Bits 0-1 = RDQI Bits 2-15 = Radiance (Bit 0 is LSB)	See above
Grid RedBand (Spatial Resolution: 275 m x 275 m, XDim = 512, YDim = 2048)					
Red Radiance/RDQI	XDim, YDim	UINT16	Radiance: $W m^{-2} sr^{-1}$ μm^{-1} (scaled) RDQI: none	Bit packed: Bits 0-1 = RDQI Bits 2-15 = Radiance (Bit 0 is LSB)	See above
Grid GreenBand (Spatial Resolution: varies, see above)					
Green Radiance/RDQI	XDim, YDim	UINT16	Radiance: $W m^{-2} sr^{-1}$ μm^{-1} (scaled) RDQI: none	Bit packed: Bits 0-1 = RDQI Bits 2-15 = Radiance (Bit 0 is LSB)	See above
Grid BlueBand (Spatial Resolution: varies, see above)					
Blue Radiance/RDQI	XDim, YDim	UINT16	Radiance: $W m^{-2} sr^{-1}$ μm^{-1} (scaled) RDQI: none	Bit packed: Bits 0-1 = RDQI Bits 2-15 = Radiance (Bit 0 is LSB)	See above

The Radiance may be obtained from the Radiance/RDQI by right-shifting 2 bits, then multiplying the result by the Scale factor contained in the Radiance Grid Metadata.

The following are flag values used for the two Geometric Parameters included in the MISR Level 1B2 MI1B2E Ellipsoid-Projected Product.

Table 6-12: Geometric Parameter Fill Values.

All Parameters		
-111 = Fill above data	-222 = Fill below data	-333 = Fill IPI invalid
-444 = Fill to side of data	-555 = Fill not processed	-999 = Fill IPI error

The following two Geometric Parameters are included in the MISR Level 1B2 MI1B2E Ellipsoid-Projected Product. See the MISR Level 1B2 MI1B2GEOP Geometric Parameters Product description elsewhere in this section for descriptions of the full set of parameters. The angles reported in the MISR Geometric Parameters product are those conventionally used by the radiative transfer community. Formal definitions of these angles may be found in the Geometric Parameters section of the MISR Level 1 Georectification and Registration Algorithm Theoretical Basis, JPL D-11532. Informal descriptions are given in figures [6-1] and [6-2].

Table 6-13: Geometric Parameters Grid Field Definitions.

Field Name	Dimension List	Type	Units	Valid Range	Flag Values
Grid GeometricParameters (Spatial Resolution: 17.6 km x 17.6 km, XDim = 8, YDim = 32)					
SolarAzimuth	XDim, YDim	FLOAT64	degrees	0.0 to 360.0	See above
SolarZenith	XDim, YDim	FLOAT64	degrees	0.0 to 90.0 +	See above

The BRF conversion factor for each band is derived from the following equation:

$$(\pi * \text{SunDistanceAU}^2) / (\text{std_solar_wgted_height} * \cos(\text{SolarZenith}))$$

This factor can be used to calculate the Bidirectional Reflectance Factor (BRF):

$$\text{BRF} = \text{BRF conversion factor} * \text{Radiance}$$

The Radiance may be obtained from the Radiance/RDQI by right-shifting 2 bits, then multiplying the result by the Scale factor contained in the Radiance Grid Metadata.

The BRF Conversion Factors use the same set of fill values as those described above in Table [6-12] “Geometric Parameters Fill Values”.

Table 6-14: BRF Conversion Factors Grid Field Definitions.

Field Name	Dimension List	Type	Units	Valid Range	Flag Values
Grid BRF Conversion Factors (Spatial Resolution: 17.6 km x 17.6 km, XDim = 8, YDim = 32)					
NIRConversionFactor	XDim, YDim	FLOAT32			
RedConversionFactor	XDim, YDim	FLOAT32			
GreenConversionFactor	XDim, YDim	FLOAT32			
BlueConversionFactor	XDim, YDim	FLOAT32			

6.4.7 Per-grid QA Metadata

Table 6-15: Ellipsoid-projected Per-grid QA Metadata.

Indicator Description	Field Name	HDF Structure	Range	bite size	Mult
<i>Swath-level Indicators</i>		<i>Swath Vgrp</i>			
Starting Block number of valid QA range	StartBlock	Type: INT32 Vdata: Global	1 - 180	4	1
Ending Block number of valid QA range	EndBlock	Type: INT32 Vdata: Global	1 - 180	4	1
Total number of samples generated	SampTotal	Type: INT32 Vdata: Band/ Mode	0 - 148,897,792	4	4
Total number of non-outside samples generated	SampNoFill	Type: INT32 Vdata: Band/ Mode	0 - 148,897,792	4	4
Number of non-outside samples generated with RDQI = 0	SampNoFillDqi0	Type: INT32 Vdata: Band/ Mode	0 - 148,897,792	4	4
Number of non-outside samples generated with RDQI = 1	SampNoFillDqi1	Type: INT32 Vdata: Band/ Mode	0 - 148,897,792	4	4
Number of non-outside samples generated with RDQI = 2	SampNoFillDqi2	Type: INT32 Vdata: Band/ Mode	0 - 148,897,792	4	4
Number of non-outside samples generated with RDQI = 3	SampNoFillDqi3	Type: INT32 Vdata: Band/ Mode	0 - 148,897,792	4	4
* sample in: 1x1 = 275m x 275m 2x2 = 550m x 550m 1x4 = 275m x 1.1km 4x4 = 1.1km x 1.1km					

6.5 MISR LEVEL 1B2 MI1B2T AND MB2LMT TERRAIN-PROJECTED PRODUCTS

6.5.1 File Metadata Description

Table 6-16: File Metadata for Terrain-projected TOA Radiance Files.

File Metadata Field Name	Definition	Data Type	Units	Valid Range
Path_number	Orbit path number	INT32	N/A	1-233
AGP_version_id	Version Identifier for Ancillary Geographic Product	INT32	N/A	2
DID_version_id	Version Identifier for DID (DTED [Digital Terrain Elevation Dataset] Intermediate Dataset)	INT32	N/A	4
Number_blocks	Total number of blocks	INT32	N/A	1-180
Ocean_blocks_size	Ocean_blocks.number dimension	INT32	N/A	1-180
Ocean_blocks.count	Total number of blocks containing entirely ocean radiances	INT32	N/A	1-180
Ocean_blocks.numbers	List of block numbers containing entirely ocean radiances	INT32	N/A	1-180
SOM_parameters.som_ellipsoid.a	Semimajor axis of ellipsoid	FLOAT64	meters	WGS84
SOM_parameters.som_ellipsoid.e2	Eccentricity of ellipsoid squared	FLOAT64	N/A	WGS84
SOM_parameters.som_orbit.aprime	Semimajor axis of orbit	FLOAT64	meters	Not Used
SOM_parameters.som_orbit.eprime	Eccentricity of orbit	FLOAT64	N/A	Not Used
SOM_parameters.som_orbit.gama	Longitude of perigee	FLOAT64	radians	Not Used
SOM_parameters.som_orbit.nrev	Number of revolutions	INT32	N/A	233
SOM_parameters.som_orbit.ro	Radius of circular orbit	FLOAT64	meters	7078040.8
SOM_parameters.som_orbit.i	Inclination of orbit	FLOAT64	radians	1.7157253
SOM_parameters.som_orbit.P2P1	Ratio of time of revolution over length of Earth rotation/orbit	FLOAT64	N/A	0.0068666667
SOM_parameters.som_orbit.lambda0	Geodetic longitude of ascending node at time 0	FLOAT64	radians	0 - 2Pi

File Metadata Field Name	Definition	Data Type	Units	Valid Range
Origin_block.ulc.x	SOM X coordinate (in meters) of the upper left corner of the first block	FLOAT64	meters	6 million to 33 million
Origin_block.ulc.y	SOM Y coordinate (in meters) of the upper left corner of the first block	FLOAT64	meters	+/- 12 million
Origin_block.lrc.x	SOM X coordinate (in meters) of the lower right corner of the first block	FLOAT64	meters	6 million to 33 million
Origin_block.lrc.y	SOM Y coordinate (in meters) of the lower right corner of the first block	FLOAT64	meters	+/- 12 million
Start_block	The block number in the AGP which corresponds to the first block in this file containing data.	INT32	N/A	1 - 180 Start_block < End block
End_block	The block number in the AGP which corresponds to the last block in this file containing data.	INT32	N/A	1 - 180 Start_block < End block
Cam_mode	Indicates whether the data in this grid file were obtained in MISR global mode or local mode.	INT32	N/A	0-1 1 = global 0 = local
Num_local_modes	The number of MISR local mode acquisitions contained in this file.	INT32	N/A	0-1 0 if data is global mode
Local_mode_site_name	The geographical name of the local mode site contained in this file for local mode files; null string for global mode files.	CHAR8	N/A	string up to 12 characters in length, including null
Orbit_QA	Indication of the overall quality of the orbit data based on analysis of quality flags in the spacecraft attitude and ephemeris data. Geolocation accuracy may be impaired for orbits with poor quality orbit data.	FLOAT32	N/A	-9999.0 = NoRetrieval, -1.0 = Poor, 0.0 = Nominal
Camera	Indicator of MISR camera	INT32	N/A	Df = 1 Cf = 2 Bf = 3 Af = 4 An = 5 Aa = 6 Ba = 7 Ca = 8 Da = 9

6.5.2 Per-grid Metadata Description

Table 6-17: Per-grid Metadata for Terrain-projected TOA Radiance Grids.

Common Grid Metadata	Definition	Data Type	Valid Values
Block_size.resolution_x	Resolution of block x dimension in meters	INT32	275, 1100
Block_size.resolution_y	Resolution of block y dimension in meters	INT32	275, 1100
Block_size.size_x	Block x dimension	INT32	512, 128
Block_size.size_y	Block y dimension	INT32	2048, 512

Table 6-18: Per-grid Metadata for Terrain-projected TOA Radiance Grids.

Radiance Grid Metadata	Definition	Data Type	Valid Values
Scale factor	Multiplicative scale factor for converting the stored 14-bit number to radiance in units $W m^{-2} sr^{-1} \mu m^{-1}$	FLOAT64	<1
std_solar_wgted_height	$E_0^{std}(b)$ [$W m^{-2} \mu m^{-1}$], solar irradiances, standardized response weighted	FLOAT32	
SunDistanceAU	Approximate distance in astronomical units between the center of the earth and the center of the sun at the time MISR observes the first valid (non-fill) pixel in the swath. Replicated across bands for convenience; does not vary with band.	FLOAT64	

Table 6-19: Per-grid Metadata for Geometric Parameters and BRF Conversion Factors Grids.

Common Grid Metadata	Definition	Data Type	Valid Values
Block_size.resolution_x	Resolution of block x dimension in meters	INT32	17600
Block_size.resolution_y	Resolution of block y dimension in meters	INT32	17600
Block_size.size_x	Block x dimension	INT32	8
Block_size.size_y	Block y dimension	INT32	32

6.5.3 Per-block Metadata Description

Table 6-20: Per-block Metadata for Terrain-projected TOA Radiance File.

PerBlockMetadataCommon	Definition	Data Type	Valid Range
Block_number	Block number with respect to the Ancillary Geographic Product	INT32	1-180
Ocean_flag	Flag signalling whether the block contains entirely ocean radiances	INT8	0 = block has no ocean or is a mix of ocean and land 1 = block is entirely ocean
Block_coor_ulc_som_meter.x	Upper left corner SOM block x coordinate in meters	FLOAT64	
Block_coor_ulc_som_meter.y	Upper left corner SOM block y coordinate in meters	FLOAT64	
Block_coor_lrc_som_meter.x	Lower right corner SOM block x coordinate in meters	FLOAT64	
Block_coor_lrc_som_meter.y	Lower right corner SOM block y coordinate in meters	FLOAT64	
Data_flag	Flag signalling whether the block contains entirely fill data	INT8	0 = block contains entirely fill data 1 = block contains valid data

PerBlockMetadataRad	Definition	Data Type	Valid Range
number_transform	Number of transforms required for the block. If this number is two, then the following records occur twice.	INT32	Terrain: always 0 Ellipsoid: 0, 1, or 2
transform.ref_time	The time at which line 0 was acquired by the camera, adjusted for instrument corrections to this block.	CHAR8 * 54	
transform.start_line	Defines the starting SOM boundary for which this transform applies relative to the first block in the entire swath.	INT32	

PerBlockMetadataRad	Definition	Data Type	Valid Range
transform.number_line	Defines the ending SOM boundary for which this transform applies.	INT32	
transform.coeff_line[6]	The vector describing the line transform coefficients.	FLOAT64 * 6	
transform.coeff_samp[6]	The vector describing the sample transform coefficients.	FLOAT64 * 6	
transform.som_ctr.x	The x SOM coordinate of the center of the transform area, used in applying the transform.	FLOAT64	
transform.som_ctr.y	The y SOM coordinate of the center of the transform area, used in applying the transform.	FLOAT64	
transform.ipi_adj_sum		FLOAT64	
GDQI	Geometric Data Quality Indicator	FLOAT64	Terrain: -1.0 - 1.0 Ellipsoid: always 0.0

PerBlockMetadataTime	Definition	Data Type	Valid Range
BlockCenterTime	TAI time of the lower right pixel of the center four pixels in the current block, converted to UTC time, and displayed in CCSDS ASCII time code A format. Note: BlockCenterTime may be incorrect for the first and last blocks processed in a swath.	CHAR8 * 28	

6.5.4 Per-line Metadata Description

None.

6.5.5 Per-pixel Metadata Description

None.

6.5.6 Grid Data Set Descriptions

Table 6-21: Terrain-projected Grid Data Set Descriptions

Dimension	Description	Valid Values
SOMBlockDim	<i>SOMBlockDim</i> is the number of SOM blocks in the file. The slowest-varying dimension is implicitly the SOM block dimension. It is not shown in the tables below.	180
XDim	<i>XDim</i> is the number of lines in a block. The x dimension direction is identical to the standard SOM x dimension.	512 for 275 m parameters 128 for 1.1 km parameters 8 for 17.6 km parameters
YDim	<i>YDim</i> is the number of samples in a block. The y dimension direction is identical to the standard SOM y dimension.	2048 for 275 m parameters 512 for 1.1 km parameters 32 for 17.6 km parameters

For the Terrain-projected TOA Radiance and the Ellipsoid-projected TOA Radiance files, the spatial resolution (and therefore the XDim and YDim) of the different Grids within the file depend on the averaging mode that band is in for that particular camera. For local mode the spatial resolution is 275 m x 275 m for all cameras and bands. For the nominal Global Mode, the following table relates the spatial resolution to camera and band,

Table 6-22: Spatial Resolution Distribution for Global mode

Grid	DF	CF	BF	AF	AN	AA	BA	CA	DA
NIRBand	1.1 km x 1.1 km	1.1 km x 1.1 km	1.1 km x 1.1 km	1.1 km x 1.1 km	275 m x 275 m	1.1 km x 1.1 km	1.1 km x 1.1 km	1.1 km x 1.1 km	1.1 km x 1.1 km
RedBand	275 m x 275 m	275 m x 275 m	275 m x 275 m	275 m x 275 m	275 m x 275 m	275 m x 275 m	275 m x 275 m	275 m x 275 m	275 m x 275 m
BlueBand	1.1 km x 1.1 km	1.1 km x 1.1 km	1.1 km x 1.1 km	1.1 km x 1.1 km	275 m x 275 m	1.1 km x 1.1 km	1.1 km x 1.1 km	1.1 km x 1.1 km	1.1 km x 1.1 km
GreenBand	1.1 km x 1.1 km	1.1 km x 1.1 km	1.1 km x 1.1 km	1.1 km x 1.1 km	275 m x 275 m	1.1 km x 1.1 km	1.1 km x 1.1 km	1.1 km x 1.1 km	1.1 km x 1.1 km

The following are flag values used for each parameter.:

Table 6-23: Terrain-projected TOA Radiance Parameter Fill Values.

RDQI	Radiance
0 = Within specifications 1 = Reduced accuracy 2 = Not usable for science 3 = Unusable for any purpose	16377 = SOM location obscured by topography. 16378 = SOM location not seen by the camera, i.e., this will occur outside the swath edges and at the top and bottom of the swath 16379 = SOM location is over ocean. Blocks which contain no land whatsoever are altered to contain only fill data. This is a measure taken to save space, and it is unique to Terrain files. Refer to the corresponding Ellipsoid-Projected Radiance file for ocean radiance in these cases. 16380 = Radiance unusable due to high RDQIs

The following are the parameters that make up the file:

Table 6-24: Terrain-projected Parameters Grid Field Definitions

Field Name Parameter Description	Dimension List	Number Type	Units	Transformation	Flag Values
Grid NIRBand (Spatial Resolution: varies, see above)					
NIR Radiance/RDQI	XDim, YDim	UINT16	Radiance: $W\ m^{-2}\ sr^{-1}$ μm^{-1} (scaled) RDQI: none	Bit packed: Bits 0-1 = RDQI Bits 2-15 = Radiance (Bit 0 is LSB)	See above
Grid RedBand (Spatial Resolution: 275 m x 275 m, XDim = 512, YDim = 2048)					
Red Radiance/RDQI	XDim, YDim	UINT16	Radiance: $W\ m^{-2}\ sr^{-1}$ μm^{-1} (scaled) RDQI: none	Bit packed: Bits 0-1 = RDQI Bits 2-15 = Radiance (Bit 0 is LSB)	See above
Grid GreenBand (Spatial Resolution: varies, see above)					
Green Radiance/RDQI	XDim, YDim	UINT16	Radiance: $W\ m^{-2}\ sr^{-1}$ μm^{-1} (scaled) RDQI: none	Bit packed: Bits 0-1 = RDQI Bits 2-15 = Radiance (Bit 0 is LSB)	See above
Grid BlueBand (Spatial Resolution: varies, see above)					

Field Name Parameter Description	Dimension List	Number Type	Units	Transformation	Flag Values
Blue Radiance/RDQI	XDim, YDim	UINT16	Radiance: $W m^{-2} sr^{-1}$ μm^{-1} (scaled) RDQI: none	Bit packed: Bits 0-1 = RDQI Bits 2-15 = Radiance (Bit 0 is LSB)	See above

The Radiance may be obtained from the Radiance/RDQI by right-shifting 2 bits, then multiplying the result by the Scale factor contained in the Radiance Grid Metadata.

The following are flag values used for the two Geometric Parameters included in the MISR Level 1B2 MI1B2T Terrain-Projected Product.

Table 6-25: Geometric Parameter Fill Values.

All Parameters		
-111 = Fill above data	-222 = Fill below data	-333 = Fill IPI invalid
-444 = Fill to side of data	-555 = Fill not processed	-999 = Fill IPI error

The following two Geometric Parameters are included in the MISR Level 1B2 MI1B2T Terrain-Projected Product. See the MISR Level 1B2 MI1B2GEOP Geometric Parameters Product description elsewhere in this section for descriptions of the full set of parameters. The angles reported in the MISR Geometric Parameters product are those conventionally used by the radiative transfer community. Formal definitions of these angles may be found in the Geometric Parameters section of the MISR Level 1 Georectification and Registration Algorithm Theoretical Basis, JPL D-11532. Informal descriptions are given in figures [6-1] and [6-2].

Table 6-26: Geometric Parameters Grid Field Definitions.

Field Name	Dimension List	Type	Units	Valid Range	Flag Values
Grid GeometricParameters (Spatial Resolution: 17.6 km x 17.6 km, XDim = 8, YDim = 32)					
SolarAzimuth	XDim, YDim	FLOAT64	degrees	0.0 to 360.0	See above
SolarZenith	XDim, YDim	FLOAT64	degrees	0.0 to 90.0 +	See above

The BRF conversion factor for each band is derived from the following equation:

$$(\pi * \text{SunDistanceAU}^2) / (\text{std_solar_wgted_height} * \cos(\text{SolarZenith}))$$

This factor can be used to calculate the Bidirectional Reflectance Factor (BRF):

BRF = BRF conversion factor * Radiance

The Radiance may be obtained from the Radiance/RDQI by right-shifting 2 bits, then multiplying the result by the Scale factor contained in the Radiance Grid Metadata.

The BRF Conversion Factors use the same set of fill values as those described above in Table [6-25] “Geometric Parameters Fill Values”.

Table 6-27: BRF Conversion Factors Grid Field Definitions.

Field Name	Dimension List	Type	Units	Valid Range	Flag Values
Grid BRF Conversion Factors (Spatial Resolution: 17.6 km x 17.6 km, XDim = 8, YDim = 32)					
NIRConversionFactor	XDim, YDim	FLOAT32			
RedConversionFactor	XDim, YDim	FLOAT32			
GreenConversionFactor	XDim, YDim	FLOAT32			
BlueConversionFactor	XDim, YDim	FLOAT32			

6.5.7 Per-grid QA Metadata

Table 6-28: Terrain-projected Per-grid QA Metadata.

Indicator Description	Field Name	HDF Structure	Range	byte size	Mult
<i>Swath-level Indicators *</i>		<i>Swath Vgrp</i>			
Total number of samples generated	SampTotal	Type: INT32 Vdata: Band/ Mode	0 - 148,897,792	4	4
Total number of non-outside samples generated	SampNoFill	Type: INT32 Vdata: Band/ Mode	0 - 148,897,792	4	4
Number of non-outside samples generated with RDQI = 0	SampNoFillDqi0	Type: INT32 Vdata: Band/ Mode	0 - 148,897,792	4	4
Number of non-outside samples generated with RDQI = 1	SampNoFillDqi1	Type: INT32 Vdata: Band/ Mode	0 - 148,897,792	4	4
Number of non-outside samples generated with RDQI = 2	SampNoFillDqi2	Type: INT32 Vdata: Band/ Mode	0 - 148,897,792	4	4
Number of non-outside samples generated with RDQI = 3	SampNoFillDqi3	Type: INT32 Vdata: Band/ Mode	0 - 148,897,792	4	4

Indicator Description	Field Name	HDF Structure	Range	byte size	Mult
Starting Block number of valid QA range	StartBlock	Type: INT32 Vdata: Global	1 - 180	4	1
Ending Block number of valid QA range	EndBlock	Type: INT32 Vdata: Global	1 - 180	4	1
* sample in: 1x1 = 275m x 275m 2x2 = 550m x 550m 1x4 = 275m x 1.1km 4x4 = 1.1km x 1.1km					
<i>Block-level Indicators</i>		<i>Block Vgrps</i>			
Metadata identifying record by block number	BlockNumber	Field: INT32 Vdata: Block	1 - 180	4	180
Metadata distinguishing valid data records	ValidRecord	Field: INT8 Vdata: Block	0=not valid 1=valid	1	180
Number of Grid Cells in this block	NumGridCells	Type: INT32 Vdata: Block	2 - 62	4	180
Projection Parameter Quality Indicator read from the ancillary PP file	PPQI	Type: FLOAT64 Vdata: Block	0 - 1	8	180
Summary of the block's Geometric Data Quality	GDQI	Type: FLOAT64 Vdata: Block	-1.0 to 1.0	8	180
<i>GridCell-level Indicators</i>		<i>GridCell Vgrp</i>			*
The Geometric Data Quality Indicator (GDQI) consists of several fields used by GeoCal.		The GC Vgrp contains a GC Vdata for each block which has an unlimited number of GC records of transform quality info for that grid cell.			
Grid Cell Index (may not be implemented yet)	GridCellID	Type: UINT8 Vdata: GridCellQa	0 - 255	1	5,000
Flag representing accuracy of the transform for this grid cell	AccuracyFlag	Type: UINT8 Vdata: GridCellQa	0 = pass 1 = fail 2 = unknown	1	5,000
Flag indicating if this grid cell was subgridded	SubgridFlag	Type: UINT8 Vdata: GridCellQa	0 = no 1 = yes	1	5,000
Level of subgridding at which this grid cell resides	SubgridLevel	Type: INT32 Vdata: GridCellQa	0 - 6	4	5,000
Number of grid points investigated as possible matching candidates	PotentialGpts	Type: INT32 Vdata: GridCellQa	0 - 50	4	5,000
Number of potential grid points selected for matching attempts after meeting certain criteria	CandidateGpts	Type: INT32 Vdata: GridCellQa	0 - 50	4	5,000
Number of grid points detected as matching blunders	BlunderGpts	Type: INT32 Vdata: GridCellQa	0 - 50	4	5,000

Indicator Description	Field Name	HDF Structure	Range	byte size	Mult
Number of successfully matched grid points	MatchedGpts	Type: INT32 Vdata: GridCellQa	0 - 50	4	5,000
Average line correction for matched points	AveCorLine	Type: FLOAT64 Vdata: GridCellQa	- 20 to 20	8	5,000
Average sample correction for matched points	AveCorSample	Type: FLOAT64 Vdata: GridCellQa	- 20 to 20	8	5,000
Standard deviation of average line correction	StddevCorLine	Type: FLOAT64 Vdata: GridCellQa	0 - maxflt	8	5,000
Standard deviation of average sample correction	StddevCorSamp	Type: FLOAT64 Vdata: GridCellQa	0 - maxflt	8	5,000
Standard deviation of the image to image line transform	StddevTrmLine	Type: FLOAT64 Vdata: GridCellQa	0 - maxflt	8	5,000
Standard deviation of the image to image sample transform	StddevTrmSamp	Type: FLOAT64 Vdata: GridCellQa	0 - maxflt	8	5,000
* size multiplier is approximate; each block may have between 2 and 62 grid cells					

6.6 MISR LEVEL 1B2 MI1B2GEOP GEOMETRIC PARAMETERS PRODUCT

6.6.1 File Metadata Description

Table 6-29: File Metadata for Geometric Parameters Product Files.

File Metadata Field Name	Definition	Data Type	Units	Valid Range
Path_number	Orbit path number	INT32	N/A	1-233
AGP_version_id	Version Identifier for Ancillary Geographic Product	INT32	N/A	2
DID_version_id	Version Identifier for DID (DTED [Digital Terrain Elevation Dataset] Intermediate Dataset)	INT32	N/A	4
Number_blocks	Total number of blocks	INT32	N/A	1-180
Ocean_blocks_size	Ocean_blocks.number dimension	INT32	N/A	1-180
Ocean_blocks.count	Total number of blocks containing entirely ocean radiances	INT32	N/A	1-180
Ocean_blocks.numbers	List of block numbers containing entirely ocean radiances	INT32	N/A	1-180
SOM_parameters.som_ellipsoid.a	Semimajor axis of ellipsoid	FLOAT64	meters	WGS84
SOM_parameters.som_ellipsoid.e2	Eccentricity of ellipsoid squared	FLOAT64	N/A	WGS84
SOM_parameters.som_orbit.aprime	Semimajor axis of orbit	FLOAT64	meters	Not Used
SOM_parameters.som_orbit.eprime	Eccentricity of orbit	FLOAT64	N/A	Not Used
SOM_parameters.som_orbit.gama	Longitude of perigee	FLOAT64	radians	Not Used
SOM_parameters.som_orbit.nrev	Number of revolutions	INT32	N/A	233
SOM_parameters.som_orbit.ro	Radius of circular orbit	FLOAT64	meters	7078040.8
SOM_parameters.som_orbit.i	Inclination of orbit	FLOAT64	radians	1.7157253
SOM_parameters.som_orbit.P2P1	Ratio of time of revolution over length of Earth rotation/orbit	FLOAT64	N/A	0.0068666667
SOM_parameters.som_orbit.lambda0	Geodetic longitude of ascending node at time 0	FLOAT64	radians	0 - 2Pi

File Metadata Field Name	Definition	Data Type	Units	Valid Range
Origin_block.ulc.x	SOM X coordinate (in meters) of the upper left corner of the first block	FLOAT64	meters	6 million to 33 million
Origin_block.ulc.y	SOM Y coordinate (in meters) of the upper left corner of the first block	FLOAT64	meters	+/- 12 million
Origin_block.lrc.x	SOM X coordinate (in meters) of the lower right corner of the first block	FLOAT64	meters	6 million to 33 million
Origin_block.lrc.y	SOM Y coordinate (in meters) of the lower right corner of the first block	FLOAT64	meters	+/- 12 million
Start_block	The block number in the AGP which corresponds to the first block in this file containing data.	INT32	N/A	1 - 180 Start_block < End block
End_block	The block number in the AGP which corresponds to the last block in this file containing data.	INT32	N/A	1 - 180 Start_block < End block
Cam_mode	Indicates whether the data in this grid file was obtained in MISR global mode or local mode.	INT32	N/A	0-1 1 = global 0 = local
Num_local_modes	The number of MISR local mode acquisitions contained in this file.	INT32	N/A	0-1 0 if data is global mode
Local_mode_site_name	The geographical name of the local mode site contained in this file for local mode files; null string for global mode files.	CHAR8	N/A	string up to 12 characters in length, including null
Orbit_QA	Indication of the overall quality of the orbit data based on analysis of quality flags in the spacecraft attitude and ephemeris data. Geolocation accuracy may be impaired for orbits with poor quality orbit data.	FLOAT32	N/A	-9999.0 = NoRetrieval, -1.0 = Poor, 0.0 = Nominal

6.6.2 Per-grid Metadata Description

Table 6-30: Per-grid Metadata for Geometric Parameters Product Files.

Common Grid Metadata	Definition	Data Type	Valid Values
Block_size.resolution_x	Resolution of block x dimension in meters	INT32	17600

Common Grid Metadata	Definition	Data Type	Valid Values
Block_size.resolution_y	Resolution of block y dimension in meters	INT32	17600
Block_size.size_x	Block x dimension	INT32	8
Block_size.size_y	Block y dimension	INT32	32

Grid Metadata	Definition	Data Type	Valid Values
SunDistanceAU	Approximate distance in astronomical units between the center of the earth and the center of the sun at the time MISR observes the first valid (non-fill) pixel in the swath.	FLOAT64	

6.6.3 Per-block Metadata Description

Table 6-31: Per-block Metadata for Geometric Parameters Product Files.

PerBlockMetadataCommon	Definition	Data Type	Valid Range
Block_number	Block number with respect to the Ancillary Geographic Product	INT32	1-180
Ocean_flag	Flag signalling whether the block contains entirely ocean radiances	INT8	0 = block has no ocean or is a mix of ocean and land 1 = block is entirely ocean
Block_coor_ulc_som_meter.x	Upper left corner SOM block x coordinate in meters	FLOAT64	
Block_coor_ulc_som_meter.y	Upper left corner SOM block y coordinate in meters	FLOAT64	
Block_coor_lrc_som_meter.x	Lower right corner SOM block x coordinate in meters	FLOAT64	
Block_coor_lrc_som_meter.y	Lower right corner SOM block y coordinate in meters	FLOAT64	
Data_flag	Flag signalling whether the block contains entirely fill data	INT8	0 = block contains entirely fill data 1 = block contains valid data

PerBlockMetadataGeoparm	Definition	Data Type	Valid Range
SunDistance	Approximate distance in meters between the center of the earth and the center of the sun at the time MISR observes the first valid (non-fill) pixel in the swath. Repeated in all blocks subsequent to the block containing the first valid pixel for convenience; set to 0.0 in all blocks preceding the block containing the first valid pixel.	FLOAT64	

6.6.4 Per-line Metadata Description

None.

6.6.5 Per-pixel Metadata Description

None.

6.6.6 Grid Data Set Descriptions

Table 6-32: Geometric Parameters Product Field Dimension Descriptions

Dimension	Description	Valid Values
SOMBlockDim	<i>SOMBlockDim</i> is the number of SOM blocks in the file. The slowest-varying dimension is implicitly the SOM block dimension. It is not shown in the tables below.	180
XDim	<i>XDim</i> is the number of lines in a block. The x dimension direction is identical to the standard SOM x dimension.	8 for 17.6 km parameters
YDim	<i>YDim</i> is the number of samples in a block. The y dimension direction is identical to the standard SOM y dimension.	32 for 17.6 km parameters

The following are flag values used for each parameter.

Table 6-33: Geometric Parameter Fill Values.

All Parameters		
-111 = Fill above data	-222 = Fill below data	-333 = Fill IPI invalid
-444 = Fill to side of data	-555 = Fill not processed	-999 = Fill IPI error

The product consists of the following parameters. The angles reported in the MISR Geometric Parameters product are those conventionally used by the radiative transfer community. Formal definitions of these angles may be found in the Geometric Parameters section of the MISR Level 1 Georectification and Registration Algorithm Theoretical Basis, JPL D-11532. Informal descriptions are given in figures [6-1] and [6-2]. Scatter and Glitter angles are new additions. Scatter angle is the angle between a vector pointing from the Sun to the observed point and a vector from the observed point to the camera in question. Glitter angle is the angle between a vector from the observed point to the camera and a vector pointing in the specular reflection direction.

Table 6-34: Geometric Parameters Grid Field Definitions.

Field Name	Dimension List	Type	Units	Valid Range	Flag Values
Grid GeometricParameters (Spatial Resolution: 17.6 km x 17.6 km, XDim = 8, YDim = 32)					
SolarAzimuth	XDim, YDim	FLOAT64	degrees	0.0 to 360.0	See above
SolarZenith	XDim, YDim	FLOAT64	degrees	0.0 to 90.0 +	See above
DfAzimuth	XDim, YDim	FLOAT64	degrees	0.0 to 360.0	See above
DfZenith	XDim, YDim	FLOAT64	degrees	0.0 to 90.0	See above
CfAzimuth	XDim, YDim	FLOAT64	degrees	0.0 to 360.0	See above
CfZenith	XDim, YDim	FLOAT64	degrees	0.0 to 90.0	See above
BfAzimuth	XDim, YDim	FLOAT64	degrees	0.0 to 360.0	See above
BfZenith	XDim, YDim	FLOAT64	degrees	0.0 to 90.0	See above
AfAzimuth	XDim, YDim	FLOAT64	degrees	0.0 to 360.0	See above
AfZenith	XDim, YDim	FLOAT64	degrees	0.0 to 90.0	See above
AnAzimuth	XDim, YDim	FLOAT64	degrees	0.0 to 360.0	See above
AnZenith	XDim, YDim	FLOAT64	degrees	0.0 to 90.0	See above
AaAzimuth	XDim, YDim	FLOAT64	degrees	0.0 to 360.0	See above
AaZenith	XDim, YDim	FLOAT64	degrees	0.0 to 90.0	See above
BaAzimuth	XDim, YDim	FLOAT64	degrees	0.0 to 360.0	See above
BaZenith	XDim, YDim	FLOAT64	degrees	0.0 to 90.0	See above
CaAzimuth	XDim, YDim	FLOAT64	degrees	0.0 to 360.0	See above
CaZenith	XDim, YDim	FLOAT64	degrees	0.0 to 90.0	See above
DaAzimuth	XDim, YDim	FLOAT64	degrees	0.0 to 360.0	See above
DaZenith	XDim, YDim	FLOAT64	degrees	0.0 to 90.0	See above
DfScatter	XDim, YDim	FLOAT64	degrees	0.0 to 360.0	See above
DfGlitter	XDim, YDim	FLOAT64	degrees	0.0 to 360.0	See above

Field Name	Dimension List	Type	Units	Valid Range	Flag Values
CfScatter	XDim, YDim	FLOAT64	degrees	0.0 to 360.0	See above
CfGlitter	XDim, YDim	FLOAT64	degrees	0.0 to 360.0	See above
BfScatter	XDim, YDim	FLOAT64	degrees	0.0 to 360.0	See above
BfGlitter	XDim, YDim	FLOAT64	degrees	0.0 to 360.0	See above
AfScatter	XDim, YDim	FLOAT64	degrees	0.0 to 360.0	See above
AfGlitter	XDim, YDim	FLOAT64	degrees	0.0 to 360.0	See above
AnScatter	XDim, YDim	FLOAT64	degrees	0.0 to 360.0	See above
AnGlitter	XDim, YDim	FLOAT64	degrees	0.0 to 360.0	See above
AaScatter	XDim, YDim	FLOAT64	degrees	0.0 to 360.0	See above
AaGlitter	XDim, YDim	FLOAT64	degrees	0.0 to 360.0	See above
BaScatter	XDim, YDim	FLOAT64	degrees	0.0 to 360.0	See above
BaGlitter	XDim, YDim	FLOAT64	degrees	0.0 to 360.0	See above
CaScatter	XDim, YDim	FLOAT64	degrees	0.0 to 360.0	See above
CaGlitter	XDim, YDim	FLOAT64	degrees	0.0 to 360.0	See above
DaScatter	XDim, YDim	FLOAT64	degrees	0.0 to 360.0	See above
DaGlitter	XDim, YDim	FLOAT64	degrees	0.0 to 360.0	See above

6.6.7 Per-grid QA Metadata

None.

Figure 6-1 Sun Angles

A Cartesian coordinate system is defined in which the +z axis points into the earth, in the direction opposite the ellipsoid normal. The x axis points toward local north. The y axis completes the right-handed coordinate system, pointing east.

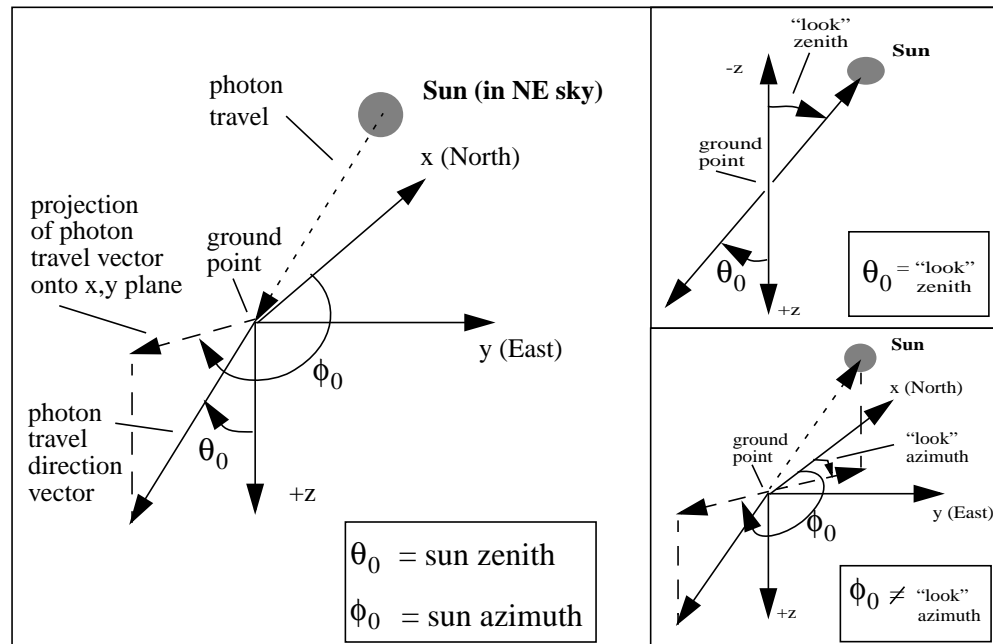

Sun Zenith is the angle between the +z axis and a vector anchored at the ground point extending into the earth in the direction of photon travel from the sun. Equivalently, it is the angle between the -z axis and a vector from the ground point to the sun. If the sun is directly overhead, the MISR sun zenith is zero. Values greater than 90 degrees may be reported when the sun is below the horizon for ground points at high latitudes.

Sun Azimuth is the angle measured clockwise from the local north vector to the projection onto the x,y plane of the photon travel direction vector. This “photon travel azimuth” convention differs from the familiar “look azimuth” by 180 degrees. Reported values range between 0 and 360 degrees. When the sun is due south of the ground point, MISR sun azimuth is 0 degrees.

Figure 6-2 Camera Angles

Camera Zenith is the angle between the -z axis and the “camera vector.” (The camera vector is anchored at the ground point and is directed toward the camera in the direction of photon travel.) Values range between 0 and 90 degrees.

Camera Azimuth is the angle measured clockwise from the local north vector to the projection onto the x,y plane of the camera vector. Values range between 0 and 360 degrees.

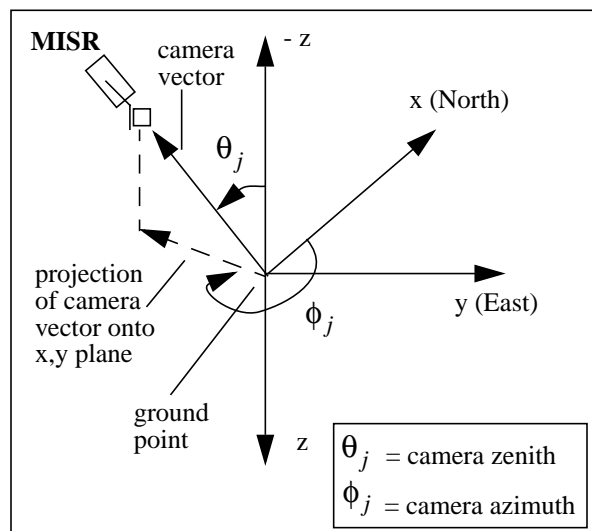

6.7 MISR LEVEL 1B2 MI1B2RCCM RCCM PRODUCT

6.7.1 File Metadata Description

Table 6-35: File Metadata for RCCM Product Files.

File Metadata Field Name	Definition	Data Type	Units	Valid Range
Path_number	Orbit path number	INT32	N/A	1-233
AGP_version_id	Version Identifier for Ancillary Geographic Product	INT32	N/A	2
DID_version_id	Version Identifier for DID (DTED [Digital Terrain Elevation Dataset] Intermediate Dataset)	INT32	N/A	4
Number_blocks	Total number of blocks	INT32	N/A	1-180
Ocean_blocks_size	Ocean_blocks.number dimension	INT32	N/A	1-180
Ocean_blocks.count	Total number of blocks containing entirely ocean radiances	INT32	N/A	1-180
Ocean_blocks.numbers	List of block numbers containing entirely ocean radiances	INT32	N/A	1-180
SOM_parameters.som_ellipsoid.a	Semimajor axis of ellipsoid	FLOAT64	meters	WGS84
SOM_parameters.som_ellipsoid.e2	Eccentricity of ellipsoid squared	FLOAT64	N/A	WGS84
SOM_parameters.som_orbit.aprime	Semimajor axis of orbit	FLOAT64	meters	Not Used
SOM_parameters.som_orbit.eprime	Eccentricity of orbit	FLOAT64	N/A	Not Used
SOM_parameters.som_orbit.gama	Longitude of perigee	FLOAT64	radians	Not Used
SOM_parameters.som_orbit.nrev	Number of revolutions	INT32	N/A	233
SOM_parameters.som_orbit.ro	Radius of circular orbit	FLOAT64	meters	7078040.8
SOM_parameters.som_orbit.i	Inclination of orbit	FLOAT64	radians	1.7157253
SOM_parameters.som_orbit.P2P1	Ratio of time of revolution over length of Earth rotation/orbit	FLOAT64	N/A	0.0068666667
SOM_parameters.som_orbit.lambda0	Geodetic longitude of ascending node at time 0	FLOAT64	radians	0 - 2Pi

File Metadata Field Name	Definition	Data Type	Units	Valid Range
Origin_block.ulc.x	SOM X coordinate (in meters) of the upper left corner of the first block	FLOAT64	meters	6 million to 33 million
Origin_block.ulc.y	SOM Y coordinate (in meters) of the upper left corner of the first block	FLOAT64	meters	+/- 12 million
Origin_block.lrc.x	SOM X coordinate (in meters) of the lower right corner of the first block	FLOAT64	meters	6 million to 33 million
Origin_block.lrc.y	SOM Y coordinate (in meters) of the lower right corner of the first block	FLOAT64	meters	+/- 12 million
Start_block	The block number in the AGP which corresponds to the first block in this file containing data.	INT32	N/A	1 - 180 Start_block < End block
End_block	The block number in the AGP which corresponds to the last block in this file containing data.	INT32	N/A	1 - 180 Start_block < End block
Cam_mode	Indicates whether the data in this grid file was obtained in MISR global mode or local mode.	INT32	N/A	0-1 1 = global 0 = local
Num_local_modes	The number of MISR local mode acquisitions contained in this file.	INT32	N/A	0-1 0 if data is global mode
Local_mode_site_name	The geographical name of the local mode site contained in this file for local mode files; null string for global mode files.	CHAR8	N/A	string up to 12 characters in length, including null
Orbit_QA	Indication of the overall quality of the orbit data based on analysis of quality flags in the spacecraft attitude and ephemeris data. Geolocation accuracy may be impaired for orbits with poor quality orbit data.	FLOAT32	N/A	-9999.0 = NoRetrieval, -1.0 = Poor, 0.0 = Nominal
Camera	Indicator of MISR camera	INT32	N/A	Df = 1 Cf = 2 Bf = 3 Af = 4 An = 5 Aa = 6 Ba = 7 Ca = 8 Da = 9

6.7.2 Per-grid Metadata Description

Table 6-36: Per-grid Metadata for RCCM Product Files.

Common Grid Metadata	Definition	Data Type	Valid Values
Block_size.resolution_x	Resolution of block x dimension in meters	INT32	275, 1100, 17600
Block_size.resolution_y	Resolution of block y dimension in meters	INT32	275, 1100, 17600
Block_size.size_x	Block x dimension	INT32	512, 128, 8
Block_size.size_y	Block y dimension	INT32	2048, 512, 32

6.7.3 Per-block Metadata Description

Table 6-37: Per-block Metadata for RCCM Product Files.

PerBlockMetadataCommon	Definition	Data Type	Valid Range
Block_number	Block number with respect to the Ancillary Geographic Product	INT32	1-180
Ocean_flag	Flag signalling whether the block contains entirely ocean radiances	INT8	0 = block has no ocean or is a mix of ocean and land 1 = block is entirely ocean
Block_coor_ulc_som_meter.x	Upper left corner SOM block x coordinate in meters	FLOAT64	
Block_coor_ulc_som_meter.y	Upper left corner SOM block y coordinate in meters	FLOAT64	
Block_coor_lrc_som_meter.x	Lower right corner SOM block x coordinate in meters	FLOAT64	
Block_coor_lrc_som_meter.y	Lower right corner SOM block y coordinate in meters	FLOAT64	
Data_flag	Flag signalling whether the block contains entirely fill data	INT8	0 = block contains entirely fill data 1 = block contains valid data

6.7.4 Per-line Metadata Description

None.

6.7.5 Per-pixel Metadata Description

None.

6.7.6 Grid Data Set Descriptions**Table 6-38: Georectified Radiance Product Field Dimension Descriptions.**

Dimension	Description	Valid Values
SOMBlockDim	<i>SOMBlockDim</i> is the number of SOM blocks in the file. The slowest-varying dimension is implicitly the SOM block dimension. It is not shown in the tables below.	180
XDim	<i>XDim</i> is the number of lines in a block. The x dimension direction is identical to the standard SOM x dimension.	512 for 275 m parameters 128 for 1.1 km parameters 8 for 17.6 km parameters
YDim	<i>YDim</i> is the number of samples in a block. The y dimension direction is identical to the standard SOM y dimension.	2048 for 275 m parameters 512 for 1.1 km parameters 32 for 17.6 km parameters

For the Terrain-projected TOA Radiance and the Ellipsoid-projected TOA Radiance files, the spatial resolution (and therefore the XDim and YDim) of the different Grids within the file depend on the averaging mode that band is in for that particular camera. For the nominal Global Mode called “Super Stereo”, the following table relates the spatial resolution to camera and band.

Table 6-39: Spatial Resolution Distribution for Global mode

Grid	DF	CF	BF	AF	AN	AA	BA	CA	DA
NIRBand	1.1 km x 1.1 km	1.1 km x 1.1 km	1.1 km x 1.1 km	1.1 km x 1.1 km	275 m x 275 m	1.1 km x 1.1 km	1.1 km x 1.1 km	1.1 km x 1.1 km	1.1 km x 1.1 km
RedBand	275 m x 275 m	275 m x 275 m	275 m x 275 m	275 m x 275 m	275 m x 275 m	275 m x 275 m	275 m x 275 m	275 m x 275 m	275 m x 275 m
BlueBand	1.1 km x 1.1 km	1.1 km x 1.1 km	1.1 km x 1.1 km	1.1 km x 1.1 km	275 m x 275 m	1.1 km x 1.1 km	1.1 km x 1.1 km	1.1 km x 1.1 km	1.1 km x 1.1 km
GreenBand	1.1 km x 1.1 km	1.1 km x 1.1 km	1.1 km x 1.1 km	1.1 km x 1.1 km	275 m x 275 m	1.1 km x 1.1 km	1.1 km x 1.1 km	1.1 km x 1.1 km	1.1 km x 1.1 km

The following are the parameters that make up the file.

Table 6-40: RCCM Parameters Grid Field Definitions.

Field Name Parameter Description	Dimension List	Number Type	Units	Transformation	Flag Values
Grid RCCM (Spatial Resolution: 1.1 km x 1.1 km, XDim = 128, YDim = 512)					
Cloud	XDim, YDim	UINT8	none	n/a	0 = no retrieval 1 = Cloud with high confidence 2 = Cloud with low confidence 3 = Clear with low confidence 4 = Clear with high confidence 255 = Fill
Glitter	XDim, YDim	UINT8	none	n/a	0 = Not glitter contaminated 1 = Glitter contaminated 255 = Fill
Quality	XDim, YDim	UINT8	none	n/a	0 = no retrieval 1 = Secondary test used only 2 = Primary test used only 3 = Both primary and secondary tests used 255 = Fill

6.7.7 Per-grid QA Metadata

Table 6-41: RCCM Per-grid QA Metadata.

Indicator Description	Field Name	HDF Structure	Range	byte size	Mult
<i>Swath-level Indicators</i>		<i>Swath Vgrp</i>			
Starting Block number of valid QA range	Start_block	Type: INT32 Vdata: Global	1 - 180	4	1
Ending Block number of valid QA range	End_block	Type: INT32 Vdata: Global	1 - 180	4	1
Total number of RCCM's generated	RCCM_total	Type: INT32 Vdata: Global	0 - 9,306,112	4	4

Indicator Description	Field Name	HDF Structure	Range	byte size	Mult
Total number of RCCM's classified Both Primary and Secondary Tests Used	RCCM_both	Type: INT32 Vdata: Global	0 - 9,306,112	4	4
Total number of RCCM's classified Primary Test Used Only	RCCM_primary	Type: INT32 Vdata: Global	0 - 9,306,112	4	4
Total number of RCCM's classified Secondary Test Used Only	RCCM_secondary	Type: INT32 Vdata: Global	0 - 9,306,112	4	4
Total number of RCCM's classified No Retrieval	RCCM_noretrieve	Type: INT32 Vdata: Global	0 - 9,306,112	4	4
Total number of RCCM's classified Not Glitter Contaminated	RCCM_glitter	Type: INT32 Vdata: Global	0 - 9,306,112	4	4
Total number of RCCM's classified Glitter Contaminated	RCCM_noglitter	Type: INT32 Vdata: Global	0 - 9,306,112	4	4

6.8 MISR LEVEL 1B2 MISRBR ELLIPSOID PROJECTED BROWSE PRODUCT

The MISR Ellipsoid Browse product is generated by making a JPEG color image out of the MI1B2E red, green and blue band data. A separate browse product is generated for each of the nine camera views. Each browse product is therefore an image of the entire MISR swath from a particular camera view. In order to limit the size of the browse file to something manageable, the image is sub-sampled and then compressed. Sub-sampling to 2.2km resolution is performed for all bands. Compression is accomplished with the JPEG algorithm at a 75% quality level. The image is also clipped and gamma stretched in order to make cloud, ocean and land features visible. Since the browse product is in the JPEG JFIF file format (.jpg), it contains none of the metadata typically associated with a MISR product. The image itself does contain graphical corner markers and block number labels to enable a user to locate individual MISR blocks within a browse image.

6.9 MISR LEVEL 1B2 MIB2TRPE ELLIPSOID-PROJECTED TRANSFORM PARAMETERS PRODUCT

The MISR Ellipsoid-projected Transform Parameters product is essentially an intermediate product that is exchanged between two software programs to help with the generation of the L1B2 Local Mode products. So, this product may not be available for distribution. The Ellipsoid TRP product is generated primarily by copying the file metadata, core metadata, annotations (version history metadata), and block metadata from the 1B2 ellipsoid-projected global mode file and by storing the SOM-to-New georectification transform parameters from the 1B2 ellipsoid global mode processing. In addition, equator-crossing information, level 1B1 extent information, and image coordinate correction (ICC) information are added to the file. The SOM-to-New transform parameters are applied in level 1B2 local mode processing to perform georectification on the level 1B1 radiometrically corrected product, so as to produce the level 1B2 ellipsoid-projected local mode product.

6.9.1 File Metadata Description

See Table 6-3, “File Metadata for Ellipsoid-projected TOA Radiance Files.,” on page 93 for all fields other than those described in the following table.

Table 6-42: Additional File Metadata for Ellipsoid-Projected Transform Parameter Files.

File Metadata Field Name	Definition	Data Type	Valid Range
equator_crossing.time	Equator-crossing date and time	CHAR8 * 28	
equator_crossing.longitude	Equator-crossing longitude (radians)	FLOAT64	

6.9.2 Per-block Metadata Description

See Table 6-7, “PerBlock Metadata for Ellipsoid-projected TOA Radiance File.,” on page 97 for all fields other than those described in the following table.

For each field in L1B1 Extent Per-block Metadata there is one record per block, with four values per record, one value for each band.

Table 6-43: L1B1 Extent Per-block Metadata for Ellipsoid-Projected Transform Parameter Files.

PerBlockL1b1Extent	Definition	Data Type	Valid Range
valid	Flag indicating if extent is valid for this band	INT8 * 4	0 - 1 0 = invalid 1 = valid

PerBlockL1b1Extent	Definition	Data Type	Valid Range
resolution	Resolution of min_line and max_line in units of 275-meter pixels	INT32 * 4	1, 4
min_line	Minimum L1B1 line number seen in this block	INT32 * 4	0 - 92159
max_line	Maximum L1B1 line number seen in this block	INT32 * 4	0 - 92159

6.9.3 ICC Per-gridcell Metadata Description

The following table describes the Image Coordinate Correction per-gridcell metadata. For each field for blocks with block numbers >= the start block, there are two records, one for each of the grid cells.

Table 6-44: ICC Per-gridcell Metadata for Ellipsoid-Projected Transform Parameter Files.

PerGridCell ICC	Definition	Data Type	Valid Range
block_number	Block number	INT32	1 - 180
grid_cell_index	Grid cell index	INT32	0 - 1
effective_flag	Flag to indicate if ICC is used in georegistration for this grid cell	INT8	0 - 1 0 = not used 1 = used
coeff_line	ICC line transform coefficients	FLOAT64 * 2	
coeff_sample	ICC sample transform coefficients	FLOAT64 * 2	
coeff_line_covariance	Covariance matrix for line transform coefficients	FLOAT64 * 4	
coeff_sample_covariance	Covariance matrix for sample transform coefficients	FLOAT64 * 4	
attitude_model.sensitivity_line	Combined sensitivity in image line to 1 arcsecond of attitude change in yaw, pitch, and roll	FLOAT64	
attitude_model.sensitivity_sample	Combined sensitivity in image sample to 1 arcsecond of attitude change in yaw, pitch, and roll	FLOAT64	
attitude_model.white_noise_drift_bias	Bias of gyro white noise drift, 1 sigma	FLOAT64	
attitude_model.random_walk_drift_bias	Bias of gyro random walk drift, 1 sigma	FLOAT64	

PerGridCell ICC	Definition	Data Type	Valid Range
delta_t	Time delta in seconds since the last update to the ICC transform, used to adjust covariance uncertainties	FLOAT64	
sigma_line	Sigma associated with the line correction transform	FLOAT64	
sigma_sample	Sigma associated with the sample correction transform	FLOAT64	

6.9.4 SOM-to-New Per-gridcell and Per-band Metadata Description

The following table describes the SOM-to-New per-gridcell and per-band metadata. For each field for blocks with block numbers \geq the start block, there are eight records, one for each of the four bands within each of two grid cells.

Table 6-45: SOM-to-New Per-gridcell and Per-band Metadata for Ellipsoid-Projected Transform Parameter Files.

PerGridCellSomToNew	Definition	Data Type	Valid Range
block_number	Block number	INT32	1 - 180
grid_cell_index	Grid cell index	INT32	0 - 1
band_index	Band index	INT32	0 - 3
valid	Flag indicating if SOM-to-new transform is valid for this grid cell and band	INT8	0 - 1 0 = invalid 1 = valid
som_area.start_line	Start line of an SOM area, offset from the first line of block 1, in units of 275-meter pixels	INT32	0 - 92159
som_area.start_sample	Start sample of an SOM area, offset from the leftmost (minimum SOM Y) pixel of the block containing the given range of line coordinates, in units of 275-meter pixels	INT32	0 - 2047
som_area.number_line	Number of lines in an SOM area, in units of 275-meter pixels (range of line coordinates may not span more than one block)	INT32	0, 256
som_area.number_sample	Number of samples in an SOM area, in units of 275-meter pixels	INT32	0, 2048
transform.resolution.line	Line resolution of transform, in units of 275-meter pixels	INT32	1, 4

PerGridCellSomToNew	Definition	Data Type	Valid Range
transform.resolution.sample	Sample resolution of transform, in units of 275-meter pixels	INT32	1, 4
transform.som_ctr.line	SOM center location (line) of the grid cell for which the transform applies, in units of 275-meter pixels	INT32	0 - 92159
transform.som_ctr.sample	SOM center location (sample) of the grid cell for which the transform applies, in units of 275-meter pixels	INT32	0 - 2047
transform.coeff_line	Transform coefficients	FLOAT64 * 6	
transform.coeff_sample	Transform coefficients	FLOAT64 * 6	

6.10 MISR LEVEL 1B2 MIB2TRPT TERRAIN-PROJECTED TRANSFORM PARAMETERS PRODUCT

The MISR Terrain-projected Transform Parameters product is essentially an intermediate product that is exchanged between two software programs to help with the generation of the L1B2 Local Mode products. So, this product may not be available for distribution. The Terrain TRP product is generated primarily by copying the file metadata, core metadata, annotations (version history metadata), and block metadata from the 1B2 terrain-projected global mode file and by storing the Ref-to-New and Band-to-Band georectification transform parameters from the 1B2 terrain global mode processing. In addition, equator-crossing information, level 1B1 extent information, and image coordinate correction (ICC) information are added to the file. The Ref-to-New and Band-to-Band transform parameters are applied in level 1B2 local mode processing to perform georectification on the level 1B1 radiometrically corrected product, so as to produce the level 1B2 terrain-projected local mode product.

6.10.1 File Metadata Description

See Table 6-16, “File Metadata for Terrain-projected TOA Radiance Files.,” on page 103 for all fields other than those described in the following table.

Table 6-46: Additional File Metadata for Terrain-Projected Transform Parameter Files.

File Metadata Field Name	Definition	Data Type	Valid Range
equator_crossing.time	Equator-crossing date and time	CHAR8 * 28	
equator_crossing.longitude	Equator-crossing longitude (radians)	FLOAT64	

6.10.2 Per-block Metadata Description

See Table 6-20, “Per-block Metadata for Terrain-projected TOA Radiance File.,” on page 106 for all fields other than those described in the following table.

For each field in L1B1 Extent Per-block Metadata there is one record per block, with four values per record, one value for each band.

Table 6-47: L1B1 Extent Per-block Metadata for Terrain-Projected Transform Parameter Files.

PerBlockL1b1Extent	Definition	Data Type	Valid Range
valid	Flag indicating if extent is valid for this band	INT8 * 4	0 - 1 0 = invalid 1 = valid

PerBlockL1b1Extent	Definition	Data Type	Valid Range
resolution	Resolution of min_line and max_line in units of 275-meter pixels	INT32 * 4	1, 4
min_line	Minimum L1B1 line number seen in this block	INT32 * 4	0 - 92159
max_line	Maximum L1B1 line number seen in this block	INT32 * 4	0 - 92159

6.10.3 ICC Per-gridcell Metadata Description

The following table describes the Image Coordinate Correction per-gridcell metadata. For each field for blocks with block numbers >= the start block, there are two records, one for each of the grid cells.

Table 6-48: ICC Per-gridcell Metadata for Terrain-Projected Transform Parameter Files.

PerGridCell ICC	Definition	Data Type	Valid Range
block_number	Block number	INT32	1 - 180
grid_cell_index	Grid cell index	INT32	0 - 1
effective_flag	Flag to indicate if ICC is used in georegistration for this grid cell	INT8	0 - 1 0 = not used 1 = used
coeff_line	ICC line transform coefficients	FLOAT64 * 2	
coeff_sample	ICC sample transform coefficients	FLOAT64 * 2	
coeff_line_covariance	Covariance matrix for line transform coefficients	FLOAT64 * 4	
coeff_sample_covariance	Covariance matrix for sample transform coefficients	FLOAT64 * 4	
attitude_model.sensitivity_line	Combined sensitivity in image line to 1 arcsecond of attitude change in yaw, pitch, and roll	FLOAT64	
attitude_model.sensitivity_sample	Combined sensitivity in image sample to 1 arcsecond of attitude change in yaw, pitch, and roll	FLOAT64	
attitude_model.white_noise_drift_bias	Bias of gyro white noise drift, 1 sigma	FLOAT64	
attitude_model.random_walk_drift_bias	Bias of gyro random walk drift, 1 sigma	FLOAT64	

PerGridCell ICC	Definition	Data Type	Valid Range
delta_t	Time delta in seconds since the last update to the ICC transform, used to adjust covariance uncertainties	FLOAT64	
sigma_line	Sigma associated with the line correction transform	FLOAT64	
sigma_sample	Sigma associated with the sample correction transform	FLOAT64	

6.10.4 Ref-to-New Per-subgridcell Metadata Description

The following table describes the Ref-to-New per-subgridcell metadata. For each field for blocks containing data (non-ocean blocks which are \geq start block and \leq end block) there is a record for each of the subgridcells. A block which contains data contains one or two gridcells; each gridcell can contain a variable number of subgridcells.

Table 6-49: Ref-to-New Per-subgridcell Metadata for Terrain-Projected Transform Parameter Files.

PerGridCell ICC	Definition	Data Type	Valid Range
block_number	Block number	INT32	1 - 180
grid_cell_index	Grid cell index	INT32	0 - 1
subgrid_index	Subgridcell index	INT32	≥ 0
som_area.start_line	Start line of an SOM area, offset from the first line of block 1, in units of 275-meter pixels	INT32	0 - 92159
som_area.start_sample	Start sample of an SOM area, offset from the leftmost (minimum SOM Y) pixel of the block containing the given range of line coordinates, in units of 275-meter pixels	INT32	0 - 2047
som_area.number_line	Number of lines in an SOM area, in units of 275-meter pixels (range of line coordinates may not span more than one block)	INT32	0 - 256
som_area.number_sample	Number of samples in an SOM area, in units of 275-meter pixels	INT32	0 - 2048
transform.coeff_line	Transform coefficients	FLOAT64 * 3	
transform.coeff_sample	Transform coefficients	FLOAT64 * 3	

6.10.5 Band-to-Band Per-gridcell and Per-band Metadata Description

The following table describes the Band-to-Band per-gridcell and per-band metadata. For each field for blocks with block numbers \geq the start block, there are eight records, one for each of the four bands within each of two grid cells. The “valid” flag is always set to zero for band 2 (the red band) and for all bands of both grid cells of blocks which are entirely over ocean. For blocks partly over ocean, the “valid” flag is set to zero for all bands of a grid cell which is entirely over ocean.

Table 6-50: Band-to-Band Per-gridcell and Per-band Metadata for Terrain-Projected Transform Parameter Files.

PerGridCellSomToNew	Definition	Data Type	Valid Range
block_number	Block number	INT32	1 - 180
grid_cell_index	Grid cell index	INT32	0 - 1
band_index	Band index	INT32	0 - 3
valid	Flag indicating if SOM-to-new transform is valid for this grid cell and band	INT8	0 - 1 0 = invalid 1 = valid
som_area.start_line	Start line of an SOM area, offset from the first line of block 1, in units of 275-meter pixels	INT32	0 - 92159
som_area.start_sample	Start sample of an SOM area, offset from the leftmost (minimum SOM Y) pixel of the block containing the given range of line coordinates, in units of 275-meter pixels	INT32	0 - 2047
som_area.number_line	Number of lines in an SOM area, in units of 275-meter pixels (range of line coordinates may not span more than one block)	INT32	0, 256
som_area.number_sample	Number of samples in an SOM area, in units of 275-meter pixels	INT32	0 - 2048
transform.coeff_line	Transform coefficients	FLOAT64 * 4	
transform.coeff_sample	Transform coefficients	FLOAT64 * 2	

I

7.0 MISR LEVEL 2 TOA/CLOUD PRODUCT

7.1 MISR LEVEL 2 TOA/CLOUD PRODUCT GRANULE NAMES

MISR Level 2 TOA/CLOUD Products are composed of the three granules listed below (Table 7-1).

Table 7-1: MISR Level 2 TOA/CLOUD File Granule Names.

MISR LEVEL 2 TOA/CLOUD FILE GRANULE NAME	ESDT Name	Section
MISR_AM1_TC_STEREO_Pmmm_Onnnnnn_Fff_vvvv.hdf	MIL2TCST	7.4
MISR_AM1_TC_CLASSIFIERS_Pmmm_Onnnnnn_Fff_vvvv.hdf	MIL2TCCL	7.5
MISR_AM1_TC_ALBEDO_Pmmm_Onnnnnn_Fff_vvvv.hdf	MIL2TCAL	7.6

7.2 MISR LEVEL 2 TOA/CLOUD PRODUCT GRANULE BRIEF DESCRIPTIONS

The Top-of-Atmosphere/Cloud Product consists of top-of-atmosphere (TOA) radiation information and cloud information, including Reflecting Level Reference Altitude (RLRA), Stereoscopic and Angular Signature Cloud masks, Cloud Motion Vectors (winds), Stereo-Matching results, parameters referenced to the RLRA, including bidirectional reflectance factors, view obscuration information, and texture indices, regional scene classifiers, cloud and topographic shadow masks, local (2.2-km resolution) albedos referenced to the RLRA, and coarse resolution (35.2-km) restrictive and expansive albedos.

Bidirectional reflectances of clear and cloudy regions obtained by MISR will be used to develop anisotropic reflectance models classified by cloud type, determine the spatial and temporal variability of cloud albedo, and validate coarse spatial resolution angular reflectance models generated by other instruments. Automated stereo matching of multi-angle imagery will be used to estimate cloud-top elevations and cloud motion vectors, which are then used in turn to establish the RLRA. Physically, the RLRA corresponds to the main reflecting layer, which will typically be the tops of bright clouds, or under atmospheric conditions corresponding to clear skies or thin cloud, it will be located at the surface. This information, together with morphological characteristics, will be used to provide automated classifications of cloud type. In addition, MISR albedos will help to obtain a better understanding of the nonlinear scaling between sub-grid and grid scale processes in general circulation models (GCM's).

7.3 MISR LEVEL 2 TOA/CLOUD PRODUCT GRANULE DATA SETS

The product will be produced as 3 separate ESDTs, each with one physical file (Table 7-1). Each physical file is in the HDF-EOS Grid “stacked-block” format and contains HDF-EOS Grid datasets, corresponding to parameters at 1.1 km, 2.2 km, 17.6 km, 35.2 km, or 70.4 km spatial resolution.

The grid datasets will have the usual x and y dimensions, as well as a third dimension corresponding to the SOM block number. The x and y dimensions will correspond to the number of 1.1 km², 2.2 km², 17.6 km², 35.2 km², or 70.4 km² regions in the along-track and cross-track directions. For each of the files, the number of blocks in the grid dataset will correspond exactly to the number and location of blocks in the Level 1B2 and Level 2 Aerosol/Surface Product files for the same orbit. Also, the blocks that make up the TOA/Cloud Product files are a direct subset of the blocks that make up the Ancillary Geographic Product.

Table 7-2: Level 2 TOA/CLOUD Product Files and Grid Datasets.

ESDT Shortname	Local Granule ID^a	Grid Dataset Name
MIL2TCST	MISR_AM1_TC_STEREO_Pmmm_Onnnnnn_Fff_vvvv.hdf	SubregParams
		RLRAREGParams
		DomainParams
MIL2TCCL	MISR_AM1_TC_CLASSIFIERS_Pmmm_Onnnnnn_Fff_vvvv.hdf	ASCMPParams_1.1_km
		CloudFractions_17.6_km
MIL2TCAL	MISR_AM1_TC_ALBEDO_Pmmm_Onnnnnn_Fff_vvvv.hdf	AlbedoParameters_35.2_km
		GeometricParameters_17.6_km
		ReflectingLevelParameters_2.2_km

a. Where Pmmm corresponds to the orbit path number, Onnnnnn is the absolute orbit number, cc is the camera identifier, ff is the file format version and vvvv is the version number (relating to the reprocessing of a dataset with different software and/or ancillary inputs).

7.4 MISR LEVEL 2 MIL2TCST CLOUD STEREO PRODUCT

7.4.1 File Metadata Description

Table 7-3: File Metadata for Cloud Stereo Product Files.

File Metadata Field Name	Definition	Data Type	Units	Valid Range
Path_number	Orbit path number	INT32	N/A	1-233
AGP_version_id	Version identifier for AGP	INT32	N/A	2
DID_version_id	Version Identifier for DID (<u>D</u> TED <u>D</u> igital <u>T</u> errain <u>E</u> levation <u>D</u> ataset] <u>I</u> ntermediate <u>D</u> ataset)	INT32	N/A	4
Number_blocks	Total number of blocks	INT32	N/A	1-180
Ocean_blocks_size	Ocean_blocks.number dimension	INT32	N/A	1-180
Ocean_blocks.count	Total number of blocks containing entirely ocean radiances	INT32	N/A	1-180
Ocean_blocks.numbers	List of block numbers containing entirely ocean radiances	180 x INT32	N/A	1-180
SOM_parameters.som_ellipsoid.a	Semimajor axis of ellipsoid	FLOAT64	meters	WGS84 ellipsoid (6.3781370E+06)
SOM_parameters.som_ellipsoid.e2	Eccentricity of ellipsoid squared	FLOAT64	N/A	WGS84 ellipsoid (6.6943480E-03)
SOM_parameters.som_orbit.aprime	Semimajor axis of orbit	FLOAT64	meters	1.0
SOM_parameters.som_orbit.eprime	Eccentricity of orbit	FLOAT64	N/A	1.0
SOM_parameters.som_orbit.gama	Longitude of perigee	FLOAT64	radians	1.0
SOM_parameters.som_orbit.nrev	Number of revolutions per ground track repeat cycle	INT32	N/A	233
SOM_parameters.som_orbit.ro	Radius of circular orbit	FLOAT64	meters	7.0780408E+06
SOM_parameters.som_orbit.i	Inclination of orbit (degrees)	FLOAT64	radians	1.7157253
SOM_parameters.som_orbit.P2P1	Ratio of time of revolution over length of Earth rotation/orbit	FLOAT64	N/A	6.8666667E-02

File Metadata Field Name	Definition	Data Type	Units	Valid Range
SOM_parameters.som_orbit.lambda0	Geodetic longitude of ascending node at time 0 (degrees)	FLOAT64	radians	-2pi: 2pi
Origin_block.ulc.x	SOM X coordinate (in meters) of the upper left corner of the first block	FLOAT64	meters	
Origin_block.ulc.y	SOM Y coordinate (in meters) of the upper left corner of the first block	FLOAT64	meters	
Origin_block.lrc.x	SOM X coordinate (in meters) of the lower right corner of the first block	FLOAT64	meters	
Origin_block.lrc.y	SOM Y coordinate (in meters) of the lower right corner of the first block	FLOAT64	meters	
Start_block	The block number in the AGP which corresponds to the first block in this file containing data.	INT32	N/A	1 - 180 Start_block < End block
End_block	The block number in the AGP which corresponds to the last block in this file containing data.	INT32	N/A	1 - 180 Start_block < End block
Cam_mode	Indicates whether the data in this grid file was obtained in MISR global mode or local mode.	INT32	N/A	0-1 1 = global 0 = local
Num_local_modes	The number of MISR local mode acquisitions contained in this file.	INT32	N/A	0-6 0 if data is global mode
Local_mode_site_name	The geographical name of the first local mode site contained in this file.	CHAR8	N/A	string up to 12 characters in length, including null
Orbit_QA	Indication of the overall quality of the orbit data based on analysis of quality flags in the spacecraft attitude and ephemeris data. Geolocation accuracy may be impaired for orbits with poor quality orbit data.	FLOAT32	N/A	-9999.0 = NoRetrieval, -1.0 = Poor, 0.0 = Nominal

7.4.2 Per-grid Metadata Description

Table 7-4: Per-grid Metadata for Cloud Stereo Product Files.

Common Grid Metadata	Definition	Data Type	Valid Values
Block_size.resolution_x	Resolution of block x dimension in meters	INT32	1100, 2200, 70400

Common Grid Metadata	Definition	Data Type	Valid Values
Block_size.resolution_y	Resolution of block y dimension in meters	INT32	1100, 2200, 70400
Block_size.size_x	Block x dimension	INT32	128, 64, 2
Block_size.size_y	Block y dimension	INT32	512, 256, 8

7.4.3 Per-block Metadata Description

Table 7-5: Per-block Metadata for Cloud Stereo Product Files.

PerBlockMetadataCommon	Definition	Data Type	Valid Values
Block_number	Current block number	INT32	1-180
Ocean_flag	Flag signalling whether the block contains entirely ocean radiances	INT8	0 = block has no ocean or is a mix of ocean and land 1 = block is entirely ocean
Block_coor_ulc_som_meter.x	Upper left corner SOM block x coordinate in meters	FLOAT64	
Block_coor_ulc_som_meter.y	Upper left corner SOM block y coordinate in meters	FLOAT64	
Block_coor_lrc_som_meter.x	Lower right corner SOM block x coordinate in meters	FLOAT64	
Block_coor_lrc_som_meter.y	Lower right corner SOM block y coordinate in meters	FLOAT64	
Data_flag	Flag signalling whether the block contains entirely fill data	INT8	0 = block contains entirely fill data 1 = block contains valid data

Common Per Block Metadata	Definition	Data Type	Valid Values
Geometric DQI	Geometric Data Quality Indicator copied from the L1B2 Terrain-projected parameter file.	INT32	-1 to 1

PerBlockMetadataTime	Definition	Data Type	Valid Values
BlockCenterTime	Imaging time for the block center (AN Camera) in UTC.	CHAR8	

7.4.4 Per-line Metadata Description

None.

7.4.5 Per-pixel Metadata Description

None.

7.4.6 Grid Data Set Descriptions

In order to minimize storage for the TOA/Cloud Product, many logical parameters will be packed so that each bit represents a logical value, or some number of bits within a byte or word represent a flag value.

To facilitate the interpretation of scientific data, floating point values are not scaled. Floating point values, and some integer values, may take on a flag value indicating invalid data. Currently, there is only a single flag value of -9999.0, representing missing floating point data. Missing integer data may be represented either by a value of 0 (for flag data) or -9999 (for measured data) or -99 (for measured byte integer data). Note that we may later add more flag values to distinguish the reason that the data are missing (e.g., never computed, arithmetic error, overflow, etc.).

Table 7-6: Cloud Stereo Product Field Dimension Descriptions.

Dimension	Description	Valid Values
SOMBlockDim	<i>SOMBlockDim</i> is the number of SOM blocks in the file. The slowest-varying dimension is implicitly the SOM block dimension. It is not shown in the tables below.	this can vary, with a typical value being approximately 140
XDim	<i>XDim</i> is the number of lines in a block. The x dimension direction is identical to the standard SOM x dimension.	128 for 1.1 km parameters 64 for 2.2 km parameters 8 for 17.6 km parameters 4 for 35.2 km parameters 2 for 70.4 km parameters



Table 7-6: Cloud Stereo Product Field Dimension Descriptions.

Dimension	Description	Valid Values
YDim	YDim is the number of samples in a block. The y dimension direction is identical to the standard SOM y dimension.	512 for 1.1 km parameters 256 for 2.2 km parameters 32 for 17.6 km parameters 16 for 35.2 km parameters 8 for 70.4 km parameters
NCamDim	NCamDim distinguishes the individual nine cameras	1-9. DF=1, CF=2, BF=3, AF=4, AN=5, AA=6, BA=7, CA=8, DA=9
NBandDim	NBandDim distinguishes the individual four camera bands	1-4. Blue=1, Green=2, Red=3, NIR=4.
WindDim	Number of individual cloud-motion (wind) vectors being calculated.	1-2. LowCloudBin = 1, HighCloudBin = 2.
EWHistogramDim	Number of bins in East-West direction of wind histogram	1-37
NSHistogramDim	Number of bins in North-South direction of wind histogram	1-37
WindYDisparityDim	Number of bins in the across-track (sample) Stereo Disparity Histograms that are part of the Wind-QA.	1-303
WindXDisparityDim	Number of bins in the along-track (line) Stereo Disparity Histograms that are part of the Wind-QA.	1-303

Table 7-7: Cloud Stereo Product Grid Dataset Descriptions.

Field Name Parameter Description	Dimension List	Number Type	Units	Transformation	Flag Values
SubregParams (Spatial Resolution: 1.1 km x 1.1 km, XDim = 128, YDim = 512)					
StereoHeight_BestWinds Stereoscopic height determined using the Best Quality Winds only, containing fill when a suitable wind was not available. (Feature-referenced).	XDim,YDim	INT16	m	None	No data=-9999
SDCM_BestWinds Stereoscopically-Derived Cloud Mask derived using the StereoHeight_BestWinds. Contains fill when a suitable wind was not available. (Feature-referenced).	XDim,YDim	UINT8	None	None	No Retrieval=0; CloudHC=1; CloudLC=2; NearSurface=3; Clear=4
StereoHeight_WithoutWinds Stereoscopic height calculated without a wind correction. (Feature-referenced).	XDim,YDim	INT16	m	None	No data=-9999

Field Name Parameter Description	Dimension List	Number Type	Units	Transformation	Flag Values
SDCM_WithoutWinds Stereoscopically-Derived Cloud Mask derived using the StereoHeight_WithoutWinds. (Feature-referenced).	XDim,YDim	UINT8	None	None	No Retrieval=0; CloudHC=1; CloudLC=2; NearSurface=3; Clear=4
FRRCCM_BestWinds Feature-referenced Radiometric Camera-by-camera Cloud Mask that used the StereoHeight_BestWinds for the projection. Contains fill when a suitable wind not available.	XDim,YDim	UINT8	None	None	No Retrieval=0; CloudHC=1; CloudLC=2; ClearLC=3; ClearHC=4
FRRCCM_WithoutWinds Feature-referenced Radiometric Camera-by-camera Cloud Mask that used the StereoHeight_WithoutWinds for the projection.	XDim,YDim	UINT8	None	None	No Retrieval=0; CloudHC=1; CloudLC=2; ClearLC=3; ClearHC=4
StereoHeightSource_BestWinds Stereoscopic height source flag for the BestWinds field. (Feature-referenced).	XDim,YDim	UINT8	None	None	No Retrieval=0; Preliminary Stereo=1; Surface=2; Default Cloud=3; MODIS=4
StereoOverrideFlag_BestWinds Stereoscopic override flag used in establishing reason for any stereo height overrides in the BestWinds field. (Feature-referenced).	XDim,YDim	UINT8	None	None	No Retrieval = 0 Keep Stereo=1; Above Max=2; Below Surface=3; RCCM Override=4
HeightComparisonCameraUsed_BestWinds Identifier of the camera used in retrieving the StereoHeight_BestWinds (ellipsoid referenced)	XDim,YDim	UINT8	None	None	No Retrieval=0; Df=1; Cf=2; Bf=3; Af=4; An=5; Aa=6; Ba=7; Ca=8; Da=9
StereoHeightSource_WithoutWinds Stereoscopic height source flag for the WithoutWinds field. (Feature-referenced).	XDim,YDim	UINT8	None	None	No Retrieval=0; Preliminary Stereo=1; Surface=2; Default Cloud=3; MODIS=4
StereoOverrideFlag_WithoutWinds Stereoscopic override flag used in establishing reason for any stereo height overrides in the WithoutWinds field. (Feature-referenced).	XDim,YDim	UINT8	None	None	No Retrieval=0; Keep Stereo=1; Above Max=2; Below Surface=3; RCCM Override=4

Field Name Parameter Description	Dimension List	Number Type	Units	Transformation	Flag Values
HeightComparisonCameraUsed_WithoutWinds Identifier of the camera used in retrieving the StereoHeight_WithoutWinds (ellipsoid referenced)	XDim,YDim	UINT8	None	None	No Retrieval=0; Df=1; Cf=2; Bf=3; Af=4; An=5; Aa=6; Ba=7; Ca=8; Da=9
PrelimFRStereoHeight_BestWinds Preliminary stereoscopic height derived using the Best Quality Winds only. Contains fill when no suitable wind available. (feature-referenced). Stereoscopically derived heights only - no inputs from RCCM or AGP.	XDim,YDim	INT16	m	None	No data=-9999
PrelimERStereoHeight_BestWinds Preliminary stereoscopic height derived using the Best Quality Winds only. Contains fill when no suitable wind available. (ellipsoid-referenced). Stereoscopically derived heights only - no inputs from RCCM or AGP.	XDim,YDim	INT16	m	None	No data=-9999
PrelimSDCM_BestWinds Preliminary Stereoscopically-Derived Cloud Mask derived using the BestWinds heights. Contains fill when no suitable wind available. (stereoscopically derived inputs only - no inputs used from Radiometric Camera-by-camera Cloud Mask or AGP). feature-referenced.	XDim,YDim	UINT8	None	None	No Retrieval=0; CloudHC=1; CloudLC=2; NearSurface=3; Clear=4
PrelimFRStereoHeight_WithoutWinds Preliminary stereoscopic height derived without correcting for the cloud motion. (feature-referenced). Stereoscopically derived heights only - no inputs from RCCM or AGP.	XDim,YDim	INT16	m	None	No data=-9999
PrelimERStereoHeight_WithoutWinds Preliminary stereoscopic height derived without correcting for the cloud motion. (ellipsoid-referenced). Stereoscopically derived heights only - no inputs from RCCM or AGP.	XDim,YDim	INT16	m	None	No data=-9999

Field Name Parameter Description	Dimension List	Number Type	Units	Transformation	Flag Values
PrelimSDCM_WithoutWinds Preliminary Stereoscopically-Derived Cloud Mask derived using the WithoutWinds heights. (stereoscopically derived inputs only - no inputs used from Radiometric Camera-by-camera Cloud Mask or AGP). feature-referenced.	XDim,YDim	UINT8	None	None	No Retrieval=0; CloudHC=1; CloudLC=2; NearSurface=3; Clear=4
PrelimERStereoHeight_RawWinds Preliminary stereoscopic height calculated using all available wind vectors (regardless of their quality) and defaulting back to a zero-wind vector otherwise. (ellipsoid-referenced). Stereoscopically derived heights only - no inputs from RCCM or AGP.	XDim,YDim	INT16	m	None	No data=-9999
CloudMotionBin_RawWinds Wind bin chosen (high, low, overlap) in the calculation of the RawWinds height field. (ellipsoid-referenced).	XDim,YDim	UINT8	None	None	No Retrieval=0; Low cloud bin=1; High cloud bin=2; Overlap=3
MetricValue_RawWinds M2 or M3 metric value corresponding to the PrelimERStereoHeight_RawWinds retrieval (ellipsoid-referenced)..	XDim,YDim	FLOAT32	None	None	No data=-9999.0
XDisparity_RawWinds Retrieved Along-track Disparity from Height Comparison Camera used in deriving the PrelimERStereoHeight_RawWinds. May jump between forward and aft comparison cameras within the same block (appearing discontinuous). (ellipsoid-referenced).	XDim,YDim	INT16	Pixels	None	No data=-9999
YDisparity_RawWinds Retrieved Cross-track Disparity from Height Comparison Camera used in deriving the PrelimERStereoHeight_RawWinds. May jump between forward and aft comparison cameras within the same block (appearing discontinuous). (ellipsoid-referenced)	XDim,YDim	INT16	Pixels	None	No data=-9999
MatcherMethod_RawWinds Stereoscopic matcher used in deriving the PrelimERStereoHeight_RawWinds. (ellipsoid-referenced).	XDim,YDim	UINT8	None	None	No Retrieval=0; M2=1; M3=2; RS=3; M2 & M3=4

Field Name Parameter Description	Dimension List	Number Type	Units	Transformation	Flag Values
MatchSubtype_RawWinds Stereoscopic match subtype used in deriving the PrelimERStereoHeight_RawWinds. (ellipsoid-referenced)	XDim,YDim	UINT8	None	None	No Retrieval=0; Previous Match Method=1; Pyramid Method=2
FRSnowIceMask_BestWinds Feature-referenced snow/ice mask that used the BestWinds heights for projection. Contains no_snow_ice when no suitable wind available. (feature-referenced).	XDim,YDim	UINT8	None	None	0=not snow/ice covered 1=snow/ice covered
FRSnowIceSource_BestWinds The data source for the FRSnowIceMask_BestWinds.	XDim,YDim	UINT8	None	None	No Retrieval=0; TASC: other not available=1; TASC: other out-of-bounds=2, DAO:other not available=3; DAO:other out-of-bounds=4; NSIDC:other not available=5; NSIDC:other out-of-bounds=6; MODIS=7
FRSnowIceMask_WithoutWinds Feature-referenced snow/ice mask that used the WithoutWinds heights for projection. (feature-referenced).	XDim,YDim	UINT8	None	None	0=not snow/ice covered 1=snow/ice covered
FRSnowIceSource_WithoutWind The data source for the FRSnowIceMask_WithoutWinds.	XDim,YDim	UINT8	None	None	No Retrieval=0; TASC: other not available=1; TASC: other out-of-bounds=2, DAO:other not available=3; DAO:other out-of-bounds=4; NSIDC:other not available=5; NSIDC:other out-of-bounds=6; MODIS=7
TRSnowIceMask Terrain-referenced snow/ice mask	XDim,YDim	UINT8	None	None	0=not snow/ice covered 1=snow/ice covered

Field Name Parameter Description	Dimension List	Number Type	Units	Transformation	Flag Values
TRSnowIceSource Terrain-referenced snow/ice mask and external data source	XDim,YDim	UINT8	None	None	No Retrieval=0; TASC:other not available=1; TASC:other out-of-bounds=2, DAO:other not available=3; DAO:other out-of-bounds=4; NSIDC:other not available=5; NSIDC:other out-of-bounds=6; MODIS=7;
RLRAregParams (Spatial Resolution: 2.2 km x 2.2 km, XDim = 64, YDim = 256)					
RLRA_WithoutWinds Reflecting Level Reference Altitude derived from the StereoHeight_WithoutWinds data.	XDim,YDim	INT16	m	None	No data=-9999
MinStereoHt_WithoutWinds Minimum value of the WithoutWinds stereo-scopically retrieved heights that contributed to this particular RLRA.	XDim,YDim	INT16	m	None	No data = -9999
MaxStereoHt_WithoutWinds Maximum value of the WithoutWinds stereoscopically retrieved heights that contributed to this particular RLRA.	XDim,YDim	INT16	m	None	No data = -9999
RLRAStDev_WithoutWinds RLRA standard deviation calculated from stereoscopically derived heights and surface over-rides.	XDim,YDim	INT16	m	None	No data=-9999
DomainParams (Spatial Resolution: 70.4 km x 70.4 km, XDim = 2, YDim = 8)					

Field Name Parameter Description	Dimension List	Number Type	Units	Transformation	Flag Values
CloudMotionSource Motion vector source flag	XDim,YDim	UINT8	None	None	Default motion vector used (stereo matching not attempted)=0; Wind Retrieval failed due to poor registration = 1; Default motion vector used (stereo matching failed)=2; LowCloud Wind Retrieval (stereo matching successful)=3; HighCloudWind Retrieval (stereo matching successful) = 4; LowCloudWind and HighCloudWind retrievals (stereo matching successful) = 5; No data = 253
NSCloudMotionSpeedLowCloud Bin North-South motion vector speed from low-cloud bin	XDim,YDim	FLOAT32	m/s	None	No data=-9999.0
EWCloudMotionSpeedLowCloud Bin East-West motion vector speed from low-cloud bin	XDim,YDim	FLOAT32	m/s	None	No data=-9999.0
NSCloudMotionSpeedHighCloud Bin North-South motion vector speed from high-cloud bin	XDim,YDim	FLOAT32	m/s	None	No data=-9999.0
EWCloudMotionSpeedHighCloud Bin East-West motion vector speed from high-cloud bin	XDim,YDim	FLOAT32	m/s	None	No data=-9999.0
MedianHeightLowCloudBin Median height of all those triplets contributing to the low-cloud motion vector.	XDim,YDim	FLOAT32	m	None	No data = -9999.0
MedianHeightHighCloudBin Median height of all those triplets contributing to the high-cloud motion vector.	XDim,YDim	FLOAT32	m	None	No data = -9999.0

Field Name Parameter Description	Dimension List	Number Type	Units	Transformation	Flag Values
LoHiCloudBinHeightSeparator Height separating High Cloud and Low Cloud motion vector bins	XDim,YDim	FLOAT32	m	None	No data=-9999.0
WindQualityFlagLowCloudBin The overall quality of the LowCloud Wind.	XDim,YDim	UINT8	None	None	0 = No Retrieval, 1 = Poor, 2= Unknown, 3= Good, 4 = VeryGood.
WindQualityFlagHighCloudBin The overall quality of the LowCloud Wind.	XDim,YDim	UINT8	None	None	0 = No Retrieval, 1 = Poor, 2= Unknown, 3= Good, 4 = VeryGood.
WindDisparitySummaryFlag LowCloudBin The quality of the LowCloud wind based on the disparities retrieved from the stereo-matcher.	XDim,YDim	UINT8	None	None	0 = No Retrieval, 1 = Poor, 2= Unknown, 3= Good, 4 = VeryGood.
WindDisparitySummaryFlag HighCloudBin The quality of the HighCloud wind based on the disparities retrieved from the stereo-matcher.	XDim,YDim	UINT8	None	None	0 = No Retrieval, 1 = Poor, 2= Unknown, 3= Good, 4 = VeryGood.
AlongMisregistrationErrorDf Misregistration error of the Df camera in the along-track direction. -N indicates camera is shifted N pixels in the upward direction, +N indicates camera shifted N pixels downward.	XDim,YDim	INT32	275-m pixels	None	No data = -9999
CrossMisregistrationErrorDf Misregistration error of the Df camera in the cross-track direction. -N indicates camera is shifted N pixels to the left, +N indicates camera shifted N pixels to the right.	XDim,YDim	INT32	275-m pixels	None	No data = -9999
AlongMisregistrationErrorDa Misregistration error of the Da camera in the cross-track direction.	XDim,YDim	INT32	275-m pixels	None	No data = -9999
CrossMisregistrationErrorDa Misregistration error of the Da camera in the cross-track direction.	XDim,YDim	INT32	275-m pixels	None	No data = -9999
CloudMotionSpeedHistogram motion vector speed histogram (37 X 37 bins)	XDim,YDim, EWHistogram Dim, NSHistogram Dim	37 X 37 X INT32	m/s	None	No data=0

Field Name Parameter Description	Dimension List	Number Type	Units	Transformation	Flag Values
HistogramMedianHt Median heights associated with motion vector histogram (37 X 37 bins)	XDim,YDim, EWHistogram Dim, NSHistogram Dim	37 X 37 X FLOAT32	m	None	No data=0
HistogramHtStDev Standard deviation of heights associated with motion vector histogram (37 X 37 bins)	XDim,YDim, EWHistogram Dim, NSHistogram Dim	37 X 37 X FLOAT32	m	None	No data=0
LoBndCloudMotionSpeed Lower bound of motion vector speed histogram	XDim,YDim	FLOAT32	m/s	None	No data=-9999.0
HiBndCloudMotionSpeed Upper bound of motion vector speed histogram	XDim,YDim	FLOAT32	m/s	None	No data=-9999.0
NBinsCloudMotionSpeedNS Number of bins in motion vector speed histogram, North-South direction	XDim,YDim	INT16	None	None	No data=-9999
NBinsCloudMotionSpeedEW Number of bins in motion vector speed histogram, East-West direction	XDim,YDim	INT16	None	None	No data=-9999
HeightRefCam Height retrieval reference camera	XDim,YDim	UINT8	None	None	No Retrieval=0; Df=1; Cf=2; Bf=3; Af=4; An=5; Aa=6; Ba=7; Ca=8; Da=9
HeightCompCamMostFwdScatt Height retrieval comparison camera that is the most-forward scattering of the two Height Retrieval Comparison Cameras.	XDim,YDim	UINT8	None	None	No Retrieval=0; Df=1; Cf=2; Bf=3; Af=4; An=5; Aa=6; Ba=7; Ca=8; Da=9
HeightCompCamLeastFwdScatt Height retrieval comparison camera that is the least-forward scattering.	XDim,YDim	UINT8	None	None	No Retrieval=0; Df=1; Cf=2; Bf=3; Af=4; An=5; Aa=6; Ba=7; Ca=8; Da=9
AvgScatAngMostFwd Average scattering angle for the most forward-scattering comparison camera	XDim,YDim	FLOAT32	deg	None	No data=-9999.0 or -8888 (block not processed)
AvgScatAngLeastFwd Average scattering angle for the least forward-scattering comparison camera	XDim,YDim	FLOAT32	deg	None	No data=-9999.0 or -8888 (block not processed)

Field Name Parameter Description	Dimension List	Number Type	Units	Transformation	Flag Values
CloudMotionRefCam Wind retrieval reference camera	XDim,YDim	UINT8	None	None	No Retrieval=0; Df=1; Cf=2; Bf=3; Af=4; An=5; Aa=6; Ba=7; Ca=8; Da=9
CloudMotionInterCamFwd Forward wind retrieval intermediate camera	XDim,YDim	UINT8	None	None	No Retrieval=0; Df=1; Cf=2; Bf=3; Af=4; An=5; Aa=6; Ba=7; Ca=8; Da=9
CloudMotionCompCamFwd Forward wind retrieval comparison camera	XDim,YDim	UINT8	None	None	No Retrieval=0; Df=1; Cf=2; Bf=3; Af=4; An=5; Aa=6; Ba=7; Ca=8; Da=9
CloudMotionInterCamAft Aftward wind retrieval intermediate camera	XDim,YDim	UINT8	None	None	No Retrieval=0; Df=1; Cf=2; Bf=3; Af=4; An=5; Aa=6; Ba=7; Ca=8; Da=9
CloudMotionCompCamAft Aftward wind retrieval comparison camera	XDim,YDim	UINT8	None	None	No Retrieval=0; Df=1; Cf=2; Bf=3; Af=4; An=5; Aa=6; Ba=7; Ca=8; Da=9
PeakWidthBfAnCrossDisparity Width of the two largest peaks in the Bf-An cross-track disparity distribution (in 275m pixels) that correspond to the low and high cloud winds. Used in the wind-retrieval qa.	WindDim, XDim,YDim	INT32	None	None	No data = -9999
PeakWidthBfAnAlongDisparity Width of the two largest peaks in the Bf-An along-track disparity distribution (in 275m pixels) that correspond to the low and high cloud winds. Used in the wind-retrieval qa.	WindDim, XDim,YDim	INT32	None	None	No data = -9999
PeakWidthBfDfCrossDisparity Width of the two largest peaks in the Bf-Df cross-track disparity distribution (in 275m pixels) that correspond to the low and high cloud winds. Used in the wind-retrieval qa.	WindDim, XDim,YDim	INT32	None	None	No data = -9999
PeakWidthBfDfAlongDisparity Width of the two largest peaks in the Bf-Df along-track disparity distribution (in 275m pixels) that correspond to the low and high cloud winds. Used in the wind-retrieval qa.	WindDim, XDim,YDim	INT32	None	None	No data = -9999

Field Name Parameter Description	Dimension List	Number Type	Units	Transformation	Flag Values
PeakWidthBaAnCrossDisparity Width of the two largest peaks in the Ba-An cross-track disparity distribution (in 275m pixels) that correspond to the low and high cloud winds. Used in the wind-retrieval qa.	WindDim, XDim,YDim	INT32	None	None	No data = -9999
PeakWidthBaAnAlongDisparity Width of the two largest peaks in the Ba-An along-track disparity distribution (in 275m pixels) that correspond to the low and high cloud winds. Used in the wind-retrieval qa.	WindDim, XDim,YDim	INT32	None	None	No data = -9999
PeakWidthBaDaCrossDisparity Width of the two largest peaks in the Ba-Da cross-track disparity distribution (in 275m pixels) that correspond to the low and high cloud winds. Used in the wind-retrieval qa.	WindDim, XDim,YDim	INT32	None	None	No data = -9999
PeakWidthBaDaAlongDisparity Width of the two largest peaks in the Ba-Da along-track disparity distribution (in 275m pixels) that correspond to the low and high cloud winds. Used in the wind-retrieval qa.	WindDim, XDim,YDim	INT32	None	None	No data = -9999
PeakCountsBfAnCrossDisparity Number of counts in the two largest peaks in the Bf-An cross-track disparity distribution that correspond to the low and high cloud winds. Used in the wind-retrieval qa.	XDim,YDim	INT32	None	None	No data = -9999
PeakCountsBfAnAlongDisparity Number of counts in the two largest peaks in the Bf-An along-track disparity distribution that correspond to the low and high cloud winds. Used in the wind-retrieval qa.	XDim,YDim	INT32	None	None	No data = -9999
PeakCountsBfDfCrossDisparity Number of counts in the two largest peaks in the Bf-Df cross-track disparity distribution that correspond to the low and high cloud winds. Used in the wind-retrieval qa.	XDim,YDim	INT32	None	None	No data = -9999
PeakCountsBfDfAlongDisparity Number of counts in the two largest peaks in the Bf-Df along-track disparity distribution that correspond to the low and high cloud winds. Used in the wind-retrieval qa.	XDim,YDim	INT32	None	None	No data = -9999

Field Name Parameter Description	Dimension List	Number Type	Units	Transformation	Flag Values
PeakCountsBaAnCrossDisparity Number of counts in the two largest peaks in the Ba-An cross-track disparity distribution that correspond to the low and high cloud winds. Used in the wind-retrieval qa.	XDim,YDim	INT32	None	None	No data = -9999
PeakCountsBaAnAlongDisparity Number of counts in the two largest peaks in the Ba-An along-track disparity distribution that correspond to the low and high cloud winds. Used in the wind-retrieval qa.	XDim,YDim	INT32	None	None	No data = -9999
PeakCountsBaDaCrossDisparity Number of counts in the two largest peaks in the Ba-Da cross-track disparity distribution that correspond to the low and high cloud winds. Used in the wind-retrieval qa.	XDim,YDim	INT32	None	None	No data = -9999
PeakCountsBaDaAlongDisparity Number of counts in the two largest peaks in the Ba-Da along-track disparity distribution that correspond to the low and high cloud winds. Used in the wind-retrieval qa.	XDim,YDim	INT32	None	None	No data = -9999
PeakLocationBfAnCrossDisparity Location of the two largest peaks in the Bf-An cross-track disparity distribution that correspond to the low and high cloud winds. Used in the wind-retrieval qa.	WindDim, XDim,YDim	INT32	None	None	No data = -9999
PeakLocationBfAnAlongDisparity Location of the two largest peaks in the Bf-An along-track disparity distribution that correspond to the low and high cloud winds. Used in the wind-retrieval qa.	WindDim, XDim,YDim	INT32	None	None	No data = -9999
PeakLocationBfDfCrossDisparity Location of the two largest peaks in the Bf-Df cross-track disparity distribution that correspond to the low and high cloud winds. Used in the wind-retrieval qa.	WindDim, XDim,YDim	INT32	None	None	No data = -9999
PeakLocationBfDfAlongDisparity Location of the two largest peaks in the Bf-Df along-track disparity distribution that correspond to the low and high cloud winds. Used in the wind-retrieval qa.	WindDim, XDim,YDim	INT32	None	None	No data = -9999

Field Name Parameter Description	Dimension List	Number Type	Units	Transformation	Flag Values
PeakLocationBaAnCrossDisparity Location of the two largest peaks in the Ba-An cross-track disparity distribution that correspond to the low and high cloud winds. Used in the wind-retrieval qa.	WindDim, XDim,YDim	INT32	None	None	No data = -9999
PeakLocationBaAnAlongDisparity Location of the two largest peaks in the Ba-An along-track disparity distribution that correspond to the low and high cloud winds. Used in the wind-retrieval qa.	WindDim, XDim,YDim	INT32	None	None	No data = -9999
PeakLocationBaDaCrossDisparity Location of the two largest peaks in the Ba-Da cross-track disparity distribution that correspond to the low and high cloud winds. Used in the wind-retrieval qa.	WindDim, XDim,YDim	INT32	None	None	No data = -9999
PeakLocationBaDaAlongDisparity Location of the two largest peaks in the Ba-Da along-track disparity distribution that correspond to the low and high cloud winds. Used in the wind-retrieval qa.	WindDim, XDim,YDim	INT32	None	None	No data = -9999
HistogramBfAnCrossDisparity Histogram distribution of the Bf-An cross-track disparities. Used in the wind-retrieval qa.	WindYDispa- rityDim XDim,YDim	INT16	None	None	No data = 0
HistogramBfAnAlongDisparity Histogram distribution of the Bf-An along-track disparities. Used in the wind-retrieval qa.	WindXDispa- rityDim XDim,YDim	INT16	None	None	No data = 0
HistogramBfDfCrossDisparity Histogram distribution of the Bf-Df cross-track disparities. Used in the wind-retrieval qa.	WindYDispa- rityDim XDim,YDim	INT16	None	None	No data = 0
HistogramBfDfAlongDisparity Histogram distribution of the Bf-Df along-track disparities. Used in the wind-retrieval qa.	WindXDispa- rityDim XDim,YDim	INT16	None	None	No data = 0
HistogramBaAnCrossDisparity Histogram distribution of the Ba-An cross-track disparities. Used in the wind-retrieval qa.	WindYDispa- rityDim XDim,YDim	INT16	None	None	No data = 0

Field Name Parameter Description	Dimension List	Number Type	Units	Transformation	Flag Values
HistogramBaAnAlongDisparity Histogram distribution of the Ba-An along-track disparities. Used in the wind-retrieval qa.	WindXDisparityDim XDim,YDim	INT16	None	None	No data = 0
HistogramBaDaCrossDisparity Histogram distribution of the Ba-Da cross-track disparities. Used in the wind-retrieval qa.	WindYDisparityDim XDim,YDim	INT16	None	None	No data = 0
HistogramBaDaAlongDisparity Histogram distribution of the Ba-Da along-track disparities. Used in the wind-retrieval qa.	WindXDisparityDim XDim,YDim	INT16	None	None	No data = 0
WindDisparityHistogramCross LowerBounds Lower bound (in 275m pixels) of the cross-track disparity distributions.	XDim,YDim	INT16	None	None	No data = -9999
WindDisparityHistogramCross UpperBounds Upper bound (in 275m pixels) of the cross-track disparity distributions.	XDim,YDim	INT16	None	None	No data = -9999
WindDisparityHistogramAlong LowerBounds Lower bound (in 275m pixels) of the along-track disparity distributions.	XDim,YDim	INT16	None	None	No data = -9999
WindDisparityHistogramAlong UpperBounds Upper bound (in 275m pixels) of the along-track disparity distributions.	XDim,YDim	INT16	None	None	No data = -9999
NumCloudMotionTripletsMatcher Total number of matches found by NM/M2 in the wind-retrieval process.	XDim,YDim	INT32	None	None	No data=-9999
NumCloudMotionTripletsMatcher Fwd Total number of matches found by NM/M2 for the forward triplets of cameras in the wind-retrieval process	XDim,YDim	INT32	None	None	No data = -9999
NumCloudMotionTripletsMatcher Aft Total number of matches found by NM/M2 for the Aft triplets of cameras in the wind-retrieval process	XDim,YDim	INT32	None	None	No data = -9999
NumCloudMotionTripletsDomain Cut Number of triplets surviving the cut on the AN camera position.	XDim,YDim	INT32	None	None	No data = -9999

Field Name Parameter Description	Dimension List	Number Type	Units	Transformation	Flag Values
NumCloudMotionTripletsIntoHist Number of triplets that are actually put into the wind histogram for subsequent analysis after surviving both the domain and height cuts.	XDim,YDim	INT32	None	None	No data = -9999
NumCloudMotionMatchesLow-Cloud Number of counts in the low-cloud wind histogram bin.	XDim,YDim	INT32	None	None	No data = -9999
NumCloudMotionMatchesHigh-Cloud Number of counts in the high-cloud wind histogram bin.	XDim,YDim	INT32	None	None	No data = -9999
SumCloudMotionMatchesLow-Cloud Total number of counts in all bins contributing to the low-cloud motion vector.	XDim,YDim	INT32	None	None	No data = -9999
SumCloudMotionMatchesHigh-Cloud Total number of counts contributing to the high-cloud motion vector.	XDim,YDim	INT32	None	None	No data = -9999
NumCloudMotionBinsLowCloud Number of bins contributing to the low-cloud motion vector.	XDim,YDim	INT32	None	None	No data = -9999
NumCloudMotionBinsHighCloud Number of bins contributing to the high-cloud motion vector.	XDim,YDim	INT32	None	None	No data = -9999
NumM23Prev Number of disparities assigned using M2 and verified by M3 using previous match method	XDim,YDim	INT32	None	None	No data=-9999 or -8888 (block not processed)
NumM2Prev Number of disparities assigned using M2 and not verified by M3 using previous match method	XDim,YDim	INT32	None	None	No data=-9999 or -8888 (block not processed)
NumM3Prev Number of disparities assigned using M3 using previous match method	XDim,YDim	INT32	None	None	No data=-9999 or -8888 (block not processed)
NumM23Pyr Number of disparities assigned using M2 and verified by M3 using pyramid method	XDim,YDim	INT32	None	None	No data=-9999 or -8888 (block not processed)

Field Name Parameter Description	Dimension List	Number Type	Units	Transformation	Flag Values
NumM2Pyr Number of disparities assigned using M2 and not verified by M3 using pyramid method	XDim,YDim	INT32	None	None	No data=-9999 or -8888 (block not processed)
NumM3Pyr Number of disparities assigned using M3 using pyramid method	XDim,YDim	INT32	None	None	No data=-9999 or -8888 (block not processed)
NumRS Number of disparities assigned using RS	XDim,YDim	INT32	None	None	No data=-9999 or -8888 (block not processed)
NumDisparitiesPrevMostFwd Number of disparities assigned using previous match method and choosing most fwd-scattering camera pair	XDim,YDim	INT32	None	None	No data=-9999 or -8888 (block not processed)
NumDisparitiesPrevLeastFwd Number of disparities assigned using previous match method and choosing least fwd-scattering camera pair	XDim,YDim	INT32	None	None	No data=-9999 or -8888 (block not processed)
NumDisparitiesPyrMostFwd Number of disparities assigned using pyramid method and choosing most fwd-scattering camera pair	XDim,YDim	INT32	None	None	No data=-9999 or -8888 (block not processed)
NumDisparitiesPyrLeastFwd Number of disparities assigned using pyramid method and choosing least fwd-scattering camera pair	XDim,YDim	INT32	None	None	No data=-9999 or -8888 (block not processed)
NumDisparitiesPrev Number of disparities assigned using previous match method	XDim,YDim	INT32	None	None	No data=-9999 or -8888 (block not processed)
NumDisparitiesPyr Number of disparities assigned using pyramid method	XDim,YDim	INT32	None	None	No data=-9999 or -8888 (block not processed)
NumM23SkewHCPrevMostFwd Number of disparities determined using M2 confirmed by M3, and having HC ray skewness (previous match method, most fwd-scattering camera pair)	XDim,YDim	INT32	None	None	No data=-9999 or -8888 (block not processed)
NumM23SkewLCPrevMostFwd Number of disparities determined using M2 confirmed by M3, and having LC ray skewness (previous match method, most fwd-scattering camera pair)	XDim,YDim	INT32	None	None	No data=-9999 or -8888 (block not processed)

Field Name Parameter Description	Dimension List	Number Type	Units	Transformation	Flag Values
NumM23SkewBlunderPrevMostFwd Number of disparities determined using M2 confirmed by M3, and having ray skewness blunder (previous match method, most fwd-scattering camera pair)	XDim,YDim	INT32	None	None	No data=-9999 or -8888 (block not processed)
NumM23SkewHCPrevLeastFwd Number of disparities determined using M2 confirmed by M3, and having HC ray skewness (previous match method, least fwd-scattering camera pair)	XDim,YDim	INT32	None	None	No data=-9999 or -8888 (block not processed)
NumM23SkewLCPrevLeastFwd Number of disparities determined using M2 confirmed by M3, and having LC ray skewness (previous match method, least fwd-scattering camera pair)	XDim,YDim	INT32	None	None	No data=-9999 or -8888 (block not processed)
NumM23SkewBlunderPrevLeast_Fwd Number of disparities determined using M2 confirmed by M3, and having ray skewness blunder (previous match method, least fwd-scattering camera pair)	XDim,YDim	INT32	None	None	No data=-9999 or -8888 (block not processed)
NumM23SkewHCPyrMostFwd Number of disparities determined using M2 confirmed by M3, and having HC ray skewness (pyramid method, most fwd-scattering camera pair)	XDim,YDim	INT32	None	None	No data=-9999 or -8888 (block not processed)
NumM23SkewLCPyrMostFwd Number of disparities determined using M2 confirmed by M3, and having LC ray skewness (pyramid method, most fwd-scattering camera pair)	XDim,YDim	INT32	None	None	No data=-9999 or -8888 (block not processed)
NumM23SkewBlunderPyrMostFwd Number of disparities determined using M2 confirmed by M3, and having ray skewness blunder (pyramid method, most fwd-scattering camera pair)	XDim,YDim	INT32	None	None	No data=-9999 or -8888 (block not processed)

Field Name Parameter Description	Dimension List	Number Type	Units	Transformation	Flag Values
NumM23SkewHCPyrLeastFwd Number of disparities determined using M2 confirmed by M3, and having HC ray skewness (pyramid method, least fwd-scattering camera pair)	XDim,YDim	INT32	None	None	No data=-9999 or -8888 (block not processed)
NumM23SkewLCPyrLeastFwd Number of disparities determined using M2 confirmed by M3, and having LC ray skewness (pyramid method, least fwd-scattering camera pair)	XDim,YDim	INT32	None	None	No data=-9999 or -8888 (block not processed)
NumM23SkewBlunderPyrLeast_Fwd Number of disparities determined using M2 confirmed by M3, and having ray skewness blunder (pyramid method, least fwd-scattering camera pair)	XDim,YDim	INT32	None	None	No data=-9999 or -8888 (block not processed)
NumM2SkewHCPrevMostFwd Number of disparities determined using M2 not confirmed by M3, and having HC ray skewness (previous match method, most fwd-scattering camera pair)	XDim,YDim	INT32	None	None	No data=-9999 or -8888 (block not processed)
NumM2SkewLCPrevMostFwd Number of disparities determined using M2 not confirmed by M3, and having LC ray skewness (previous match method, most fwd-scattering camera pair)	XDim,YDim	INT32	None	None	No data=-9999 or -8888 (block not processed)
NumM2SkewBlunderPrevMostFwd Number of disparities determined using M2 not confirmed by M3, and having ray skewness blunder (previous match method, most fwd-scattering camera pair)	XDim,YDim	INT32	None	None	No data=-9999 or -8888 (block not processed)
NumM2SkewHCPrevLeastFwd Number of disparities determined using M2 and having HC ray skewness (previous match method, least fwd-scattering camera pair)	XDim,YDim	INT32	None	None	No data=-9999 or -8888 (block not processed)
NumM2SkewLCPrevLeastFwd Number of disparities determined using M2 and having LC ray skewness (previous match method, least fwd-scattering camera pair)	XDim,YDim	INT32	None	None	No data=-9999 or -8888 (block not processed)

Field Name Parameter Description	Dimension List	Number Type	Units	Transformation	Flag Values
NumM2SkewBlunderPrevLeast Fwd Number of disparities determined using M2 and having ray skewness blunder (previous match method, least fwd-scattering camera pair)	XDim,YDim	INT32	None	None	No data=-9999 or -8888 (block not processed)
NumM2SkewHCPyrMostFwd Number of disparities determined using M2 not confirmed by M3, and having HC ray skewness (pyramid method, most fwd-scattering camera pair)	XDim,YDim	INT32	None	None	No data=-9999 or -8888 (block not processed)
NumM2SkewLCPyrMostFwd Number of disparities determined using M2 not confirmed by M3, and having LC ray skewness (pyramid method, most fwd-scattering camera pair)	XDim,YDim	INT32	None	None	No data=-9999 or -8888 (block not processed)
NumM2SkewBlunderPyrMostFwd Number of disparities determined using M2 not confirmed by M3, and having ray skewness blunder (pyramid method, most fwd-scattering camera pair)	XDim,YDim	INT32	None	None	No data=-9999 or -8888 (block not processed)
NumM2SkewHCPyrLeastFwd Number of disparities determined using M2 and having HC ray skewness (pyramid method, least fwd-scattering camera pair)	XDim,YDim	INT32	None	None	No data=-9999 or -8888 (block not processed)
NumM2SkewLCPyrLeastFwd Number of disparities determined using M2 and having LC ray skewness (pyramid method, east fwd-scattering camera pair)	XDim,YDim	INT32	None	None	No data=-9999 or -8888 (block not processed)
NumM2SkewBlunderPyrLeastFwd Number of disparities determined using M2 and having ray skewness blunder pyramid method, (least fwd-scattering camera pair)	XDim,YDim	INT32	None	None	No data=-9999 or -8888 (block not processed)
NumM3SkewHCPrevMostFwd Number of disparities determined using M3 and having HC ray skewness (previous match method, most fwd-scattering camera pair)	XDim,YDim	INT32	None	None	No data=-9999 or -8888 (block not processed)

Field Name Parameter Description	Dimension List	Number Type	Units	Transformation	Flag Values
NumM3SkewLCPrevMostFwd Number of disparities determined using M3 and having LC ray skewness (previous match method, most fwd-scattering camera pair)	XDim,YDim	INT32	None	None	No data=-9999 or -8888 (block not processed)
NumM3SkewBlunderPrevMostFwd Number of disparities determined using M3 and having ray skewness blunder (previous match method, most fwd-scattering camera pair)	XDim,YDim	INT32	None	None	No data=-9999 or -8888 (block not processed)
NumM3SkewHCPrevLeastFwd Number of disparities determined using M3 and having HC ray skewness (previous match method, least fwd-scattering camera pair)	XDim,YDim	INT32	None	None	No data=-9999 or -8888 (block not processed)
NumM3SkewLCPrevLeastFwd Number of disparities determined using M3 and having LC ray skewness (previous match method, least fwd-scattering camera pair)	XDim,YDim	INT32	None	None	No data=-9999 or -8888 (block not processed)
NumM3SkewBlunderPrevLeast_Fwd Number of disparities determined using M3 and having ray skewness blunder (previous match method, least fwd-scattering camera pair)	XDim,YDim	INT32	None	None	No data=-9999 or -8888 (block not processed)
NumM3SkewHCPyrMostFwd Number of disparities determined using M3 and having HC ray skewness (pyramid method, most fwd-scattering camera pair)	XDim,YDim	INT32	None	None	No data=-9999 or -8888 (block not processed)
NumM3SkewLCPyrMostFwd Number of disparities determined using M3 and having LC ray skewness (pyramid method, most fwd-scattering camera pair)	XDim,YDim	INT32	None	None	No data=-9999 or -8888 (block not processed)
NumM3SkewBlunderPyrMostFwd Number of disparities determined using M3 and having ray skewness blunder (pyramid method, most fwd-scattering camera pair)	XDim,YDim	INT32	None	None	No data=-9999 or -8888 (block not processed)
NumM3SkewHCPyrLeastFwd Number of disparities determined using M3 and having HC ray skewness (pyramid method, least fwd-scattering camera pair)	XDim,YDim	INT32	None	None	No data=-9999 or -8888 (block not processed)

Field Name Parameter Description	Dimension List	Number Type	Units	Transformation	Flag Values
NumM3SkewLCPyrLeastFwd Number of disparities determined using M3 and having LC ray skewness (pyramid method, least fwd-scattering camera pair)	XDim,YDim	INT32	None	None	No data=-9999 or -8888 (block not processed)
NumM3SkewBlunderPyrLeastFwd Number of disparities determined using M3 and having ray skewness blunder (pyramid method, least fwd-scattering camera pair)	XDim,YDim	INT32	None	None	No data=-9999 or -8888 (block not processed)
NumRSSkewHCMostFwd Number of disparities determined using RS and having HC ray skewness (most fwd-scattering camera pair)	XDim,YDim	INT32	None	None	No data=-9999 or -8888 (block not processed)
NumRSSkewLCMostFwd Number of disparities determined using RS and having LC ray skewness (most fwd-scattering camera pair)	XDim,YDim	INT32	None	None	No data=-9999 or -8888 (block not processed)
NumRSSkewBlunderMostFwd Number of disparities determined using RS and having ray skewness blunder (most fwd-scattering camera pair)	XDim,YDim	INT32	None	None	No data=-9999 or -8888 (block not processed)
NumRSSkewHCLeastFwd Number of disparities determined using RS and having HC ray skewness (least fwd-scattering camera pair)	XDim,YDim	INT32	None	None	No data=-9999 or -8888 (block not processed)
NumRSSkewLCleastFwd Number of disparities determined using RS and having LC ray skewness (least fwd-scattering camera pair)	XDim,YDim	INT32	None	None	No data=-9999 or -8888 (block not processed)
NumRSSkewBlunderLeastFwd Number of disparities determined using RS and having ray skewness blunder (least fwd-scattering camera pair)	XDim,YDim	INT32	None	None	No data=-9999 or -8888 (block not processed)

7.4.7 Per-grid QA Metadata

Table 7-8: Per-grid QA Metadata for Cloud Stereo Products.

Data Field Name	Data Type	Field Dimensions	Valid Range
SwathQaGlobal: Swath-level Constructs			
NNonFillDomains	INT32	--	0 - 2272
NSuccMotionVectorDomains	INT32	--	0 - 2272
NDisparitiesMostFwdScat	INT32	--	0 - 9,306,112
NDisparitiesLeastFwdScat	INT32	--	0 - 9,306,112
NM23Disparities	INT32	--	0 - 9,306,112
NM2Disparities	INT32	--	0 - 9,306,112
NM3Disparities	INT32	--	0 - 9,306,112
NRSDisparities	INT32	--	0 - 9,306,112
NNoRetrievalDisparities	INT32	--	0 - 9,306,112
NNonFillSubregions	INT32	--	0 - 9,306,112
NMODISFRSnowIce	INT32	--	0 - 9,306,112
NNSIDCFRSnowIceMODISOutOfBds	INT32	--	0 - 9,306,112
NNSIDCFRSnowIceMODISNA	INT32	--	0 - 9,306,112
NDAOFRSnowIceNSIDCOutOfBds	INT32	--	0 - 9,306,112
NDAOFRSnowIceNSIDCNA	INT32	--	0 - 9,306,112
NTASCFRSnowIceDAOOutOfBds	INT32	--	0 - 9,306,112
NTASCFRSnowIceDAONA	INT32	--	0 - 9,306,112
NNonFillSubWGoodMODISCIIdMask	INT32	--	0 - 9,306,112
NNonFillSubWBadMODISCIIdMask	INT32	--	0 - 9,306,112
NNonFillSubWNA MODISCIIdMask	INT32	--	0 - 9,306,112
NNonFillSubWGoodMODISCIIdHt	INT32	--	0 - 9,306,112
NNonFillSubWBadMODISCIIdHt	INT32	--	0 - 9,306,112
NNonFillSubWNA MODISCIIdHt	INT32	--	0 - 9,306,112
NNonFillSubSolarOblique	INT32	--	0 - 9,306,112
BlockQaGlobal: Block-level Constructs			
BlockNumber	INT32	--	1 - 180
ValidRecord	UINT8	--	0, 1

Data Field Name	Data Type	Field Dimensions	Valid Range
TpGeomDataQualInd	FLOAT64	NCAM	-1 - 1
NSubLowMotionVectorBin	INT32	--	0 - 65,536
NSubHighMotionVectorBin	INT32	--	0 - 65,536
NSubOverlapMotionVectorBin	INT32	--	0 - 65,536
NSubNoRetrMotionVectorBin	INT32	--	0 - 65,536
NTRSubSnowIce	INT32	--	0 - 65,536
NFRSubSnowIce	INT32	--	0 - 65,536
NM23MostFwdScat	INT32	--	0 - 65,536
NM23LeastFwdScat	INT32	--	0 - 65,536
NM2MostFwdScat	INT32	--	0 - 65,536
NM2LeastFwdScat	INT32	--	0 - 65,536
NM3MostFwdScat	INT32	--	0 - 65,536
NM3LeastFwdScat	INT32	--	0 - 65,536
NRSMostFwdScat	INT32	--	0 - 65,536
NRSLeastFwdScat	INT32	--	0 - 65,536
NSubStereoHtOverridWSurf	INT32	--	0 - 65,536
NSubStereoHtOverridWDef	INT32	--	0 - 65,536
NSubStereoHtFromMODIS	INT32	--	0 - 65,536
NSubStereoHtNR	INT32	--	0 - 65,536
NDefaultRLRA	INT32	--	0 - 16,384
NNoRetrievalRLRA	INT32	--	0 - 16,384
MeanRLRA	FLOAT32	--	0.0 - 20,000 m

7.5 MISR LEVEL 2 MIL2TCCL CLOUD CLASSIFIER PRODUCT

7.5.1 File Metadata Description

Table 7-9: File Metadata for Cloud Classifier Product Files.

File Metadata Field Name	Definition	Data Type	Units	Valid Range
Path_number	Orbit path number	INT32	N/A	1-233
AGP_version_id	Version identifier for AGP	INT32	N/A	2
DID_version_id	Version Identifier for DID (DTED Digital Terrain Elevation Dataset] Intermediate Dataset)	INT32	N/A	4
Number_blocks	Total number of blocks	INT32	N/A	1-180
Ocean_blocks_size	Ocean_blocks.number dimension	INT32	N/A	1-180
Ocean_blocks.count	Total number of blocks containing entirely ocean radiances	INT32	N/A	1-180
Ocean_blocks.numbers	List of block numbers containing entirely ocean radiances	180 x INT32	N/A	1-180
SOM_parameters.som_ellipsoid.a	Semimajor axis of ellipsoid	FLOAT64	meters	WGS84 ellipsoid (6.3781370E+06)
SOM_parameters.som_ellipsoid.e2	Eccentricity of ellipsoid squared	FLOAT64	N/A	WGS84 ellipsoid (6.6943480E-03)
SOM_parameters.som_orbit.aprime	Semimajor axis of orbit	FLOAT64	meters	1.0
SOM_parameters.som_orbit.eprime	Eccentricity of orbit	FLOAT64	N/A	1.0
SOM_parameters.som_orbit.gama	Longitude of perigee	FLOAT64	radians	1.0
SOM_parameters.som_orbit.nrev	Number of revolutions per ground track repeat cycle	INT32	N/A	233
SOM_parameters.som_orbit.ro	Radius of circular orbit	FLOAT64	meters	7.0780408E+06
SOM_parameters.som_orbit.i	Inclination of orbit (degrees)	FLOAT64	radians	1.7157253
SOM_parameters.som_orbit.P2P1	Ratio of time of revolution over length of Earth rotation/orbit	FLOAT64	N/A	6.8666667E-02

File Metadata Field Name	Definition	Data Type	Units	Valid Range
SOM_parameters.som_orbit.lambda0	Geodetic longitude of ascending node at time 0 (degrees)	FLOAT64	radians	-2pi : 2pi
Origin_block.ulc.x	SOM X coordinate (in meters) of the upper left corner of the first block	FLOAT64	meters	
Origin_block.ulc.y	SOM Y coordinate (in meters) of the upper left corner of the first block	FLOAT64	meters	
Origin_block.lrc.x	SOM X coordinate (in meters) of the lower right corner of the first block	FLOAT64	meters	
Origin_block.lrc.y	SOM Y coordinate (in meters) of the lower right corner of the first block	FLOAT64	meters	
Start_block	The block number in the AGP which corresponds to the first block in this file containing data.	INT32	N/A	1 - 180 Start_block < End block
End_block	The block number in the AGP which corresponds to the last block in this file containing data.	INT32	N/A	1 - 180 Start_block < End block
Cam_mode	Indicates whether the data in this grid file was obtained in MISR global mode or local mode.	INT32	N/A	0-1 1 = global 0 = local
Num_local_modes	The number of MISR local mode acquisitions contained in this file.	INT32	N/A	0-6 0 if data is global mode
Local_mode_site_name	The geographical name of the first local mode site contained in this file.	CHAR8	N/A	string up to 12 characters in length, including null
Orbit_QA	Indication of the overall quality of the orbit data based on analysis of quality flags in the spacecraft attitude and ephemeris data. Geolocation accuracy may be impaired for orbits with poor quality orbit data.	FLOAT32	N/A	-9999.0 = NoRetrieval, -1.0 = Poor, 0.0 = Nominal

7.5.2 Per-grid Metadata Description

Table 7-10: Per-grid Metadata for Cloud Classifier Product Files.

Common Grid Metadata	Definition	Data Type	Valid Values
Block_size.resolution_x	Resolution of block x dimension in meters	INT32	1100, 17600

Common Grid Metadata	Definition	Data Type	Valid Values
Block_size.resolution_y	Resolution of block y dimension in meters	INT32	1100, 17600
Block_size.size_x	Block x dimension	INT32	128, 8
Block_size.size_y	Block y dimension	INT32	512, 32

7.5.3 Per-block Metadata Description

Table 7-11: Per-block Metadata for Cloud Classifier Product Files.

PerBlockMetadataCommon	Definition	Data Type	Valid Values
Block_number	Current block number	INT32	1-180
Ocean_flag	Flag signalling whether the block contains entirely ocean radiances	INT8	0 = block has no ocean or is a mix of ocean and land 1 = block is entirely ocean
Block_coor_ulc_som_meter.x	Upper left corner SOM block x coordinate in meters	FLOAT64	
Block_coor_ulc_som_meter.y	Upper left corner SOM block y coordinate in meters	FLOAT64	
Block_coor_lrc_som_meter.x	Lower right corner SOM block x coordinate in meters	FLOAT64	
Block_coor_lrc_som_meter.y	Lower right corner SOM block y coordinate in meters	FLOAT64	
Data_flag	Flag signalling whether the block contains entirely fill data	INT8	0 = block contains entirely fill data 1 = block contains valid data

Common Per Block Metadata	Definition	Data Type	Valid Values
Geometric DQI	Geometric Data Quality Indicator copied from the L1B2 Terrain-projected parameter file.	INT32	-1 to 1

PerBlockMetadataTime	Definition	Data Type	Valid Values
BlockCenterTime	Imaging time for the block center (AN Camera) in UTC.	CHAR8	

7.5.4 Per-line Metadata Description

None.

7.5.5 Per-pixel Metadata Description

None.

7.5.6 Grid Data Set Descriptions

In order to minimize storage for the TOA/Cloud Product, many logical parameters will be packed so that each bit represents a logical value, or some number of bits within a byte or word represent a flag value.

To facilitate the interpretation of scientific data, floating point values are not scaled. Floating point values, and some integer values, may take on a flag value indicating invalid data. Currently, there is only a single flag value of -9999.0, representing missing floating point data. Missing integer data may be represented either by a value of 0 (for flag data) or -9999 (for measured data) or -99 (for measured byte integer data). Note that we may later add more flag values to distinguish the reason that the data are missing (e.g., never computed, arithmetic error, overflow, etc.).

Table 7-12: Cloud Classifier Product Field Dimension Descriptions

Dimension	Description	Valid Values
SOMBlockDim	<i>SOMBlockDim</i> is the number of SOM blocks in the file. The slowest-varying dimension is implicitly the SOM block dimension. It is not shown in the tables below.	this can vary, with a typical value being approximately 140
XDim	<i>XDim</i> is the number of lines in a block. The x dimension direction is identical to the standard SOM x dimension.	128 for 1.1 km parameters 64 for 2.2 km parameters 8 for 17.6 km parameters 4 for 35.2 km parameters 2 for 70.4 km parameters
YDim	<i>YDim</i> is the number of samples in a block. The y dimension direction is identical to the standard SOM y dimension.	512 for 1.1 km parameters 256 for 2.2 km parameters 32 for 17.6 km parameters 16 for 35.2 km parameters 8 for 70.4 km parameters

Table 7-12: Cloud Classifier Product Field Dimension Descriptions (Continued)

Dimension	Description	Valid Values
NCamDim	NCamDim distinguishes the individual nine cameras	1-9. DF=1, CF=2, BF=3, AF=4, AN=5, AA=6, BA=7, CA=8, DA=9
NBandDim	NBandDim distinguishes the individual four camera bands	1-4. Blue=1, Green=2, Red=3, NIR=4.
NAltitudeDim	NAltitudeDim is the number of altitude bins in the Regional Scene Classifiers	0-4. NoRetrieval=0, Surface=1, LowAltitude=2, MiddleAltitude=3, HighAltitude=4.

Table 7-13: Cloud Classifier Product Grid Dataset Descriptions.

Field Name Parameter Description	Dimension List	Number Type	Units	Transformation	Flag Values
ASCMPParams_1.1_km (Spatial Resolution: 1.1 km x 1.1 km, XDim = 128, YDim = 512)					
AngularSignatureCloudMask Final feature-referenced Angular Signature Cloud Mask	XDim,YDim	UINT8	None	None	NoRetrieval=0; CloudHC=1; CloudLC=2; ClearLC=3; ClearHC=4
ASCMObservable The observable that is compared against the threshold to calculate the cloud-mask. (Feature-referenced).	XDim,YDim	FLOAT32	None	None	No data = -9999.0
ASCMSRefCamScatteringAngle The scattering angle (in degrees) of the reference camera. (Feature-referenced).	XDim,YDim	FLOAT32	None	None	No data = -9999.0
ASCMSReferenceCamera ASCMS Reference Camera (one of Df, Da, Cf or Ca). (Feature-referenced).	XDim,YDim	UINT8	None	None	NoRetrieval=0; Df=1; Cf=2; Ca=8; Da=9
ASCMSComparisonCamera ASCMS Comparison Camera (one of Cf, Ca, Bf or Ba). (Feature-referenced).	XDim,YDim	UINT8	None	None	NoRetrieval=0; Cf=2; Bf=3; Ba=7; Ca=8
FwdCamTerrainRefASCMS "preliminary" terrain-referenced ASCMS as calculated using the forward cameras	XDim,YDim	UINT8	None	None	NoRetrieval=0; CloudHC=1; CloudLC=2; ClearLC=3; ClearHC=4
AftCamTerrainRefASCMS "preliminary" terrain-referenced ASCMS as calculated using the aft cameras	XDim,YDim	UINT8	None	None	NoRetrieval=0; CloudHC=1; CloudLC=2; ClearLC=3; ClearHC=4

Field Name Parameter Description	Dimension List	Number Type	Units	Transformation	Flag Values
NumProjectionsASCM The total number of terrain-referenced ASCM values projecting to this given feature-referenced pixel.	XDim,YDim	UINT8	None	None	No data=0; Not overridden=0; Overridden= >1
CloudShadowMask Cloud Shadow Mask	XDim,YDim	UINT8	None	None	No data=0; Cloud Shadow HC=1; Cloud Shadow LC=2; Cloud Free=3
TopographicShadowMask Topographic Shadow Mask	XDim,YDim	UINT8	None	None	No data=0 Not topo shadowed=1 Topo shadowed=2
CloudFractions_17.6_km (Spatial Resolution: 17.6 km x 17.6 km, XDim = 8, YDim = 32)					
CombinedFractionCloudHC Fractional area classified as containing any type of cloud with high confidence	XDim,YDim	FLOAT32	None	None	No data=-9999.0 Valid data = 0.0 - 1.0
CombinedFractionClearHC Fractional area classified as clear of any type of clear with high confidence	XDim,YDim	FLOAT32	None	None	No data=-9999.0 Valid data = 0.0 - 1.0
FractionLandPixels Fraction of 1.1 km subregions classified as land	XDim,YDim	FLOAT32	None	None	No data=-9999.0 Valid data = 0.0 - 1.0
FractionRetrievedStereo-Height The fraction of 1.1km pixels that have a stereoscopically-derived cloud-top height.	XDim,YDim	FLOAT32	None	None	No data=-9999.0 Valid data = 0.0 - 1.0
FractionDefaultStereoHeight The fraction of 1.1km pixels that have a "default" (surface override or default cloud) height.	XDim,YDim	FLOAT32	None	None	No data=-9999.0 Valid data = 0.0 - 1.0
FractionNoRetrievalStereo-Height The fraction of 1.1km pixels that do not have a retrieval for the final stereo heights..	XDim,YDim	FLOAT32	None	None	No data=-9999.0 Valid data = 0.0 - 1.0
FractionNoRetrievalPrelim-StereoHeight The fraction of 1.1km pixels that do not have a retrieval for the preliminary stereo heights..	XDim,YDim	FLOAT32	None	None	No data=-9999.0 Valid data = 0.0 - 1.0

Field Name Parameter Description	Dimension List	Number Type	Units	Transformation	Flag Values
FractionRCCMCloudHC Fraction of RCCM pixels that are CloudHC (calculated independently for all 9 angles) Derived from the terrain-referenced RCCM (output of L1B3).	XDim,YDim, NCamDim	9 X FLOAT32	None	None	No data=-9999.0 Valid data = 0.0 - 1.0
FractionRCCMCloudLC Fraction of RCCM pixels that are CloudLC (calculated independently for all 9 angles) Derived from the terrain-referenced RCCM (output of L1B3).	XDim,YDim, NCamDim	9 X FLOAT32	None	None	No data=-9999.0 Valid data = 0.0 - 1.0
FractionRCCMNoRetrieval Fraction of RCCM pixels that do not have a retrieval (calculated independently for all 9 angles) Derived from the terrain-referenced RCCM (output of L1B3).	XDim,YDim, NCamDim	9 X FLOAT32	None	None	No data=-9999.0 Valid data = 0.0 - 1.0
FractionCloudHCExcluding-ASC Fractional area classified as containing any type of cloud with high confidence, excluding clouds detected with the ASCM	XDim,YDim	FLOAT32	None	None	No data=-9999.0 Valid data = 0.0 - 1.0
FractionCloudLCExcluding-ASC Fractional area classified as containing any type of cloud with low confidence, excluding clouds detected with the ASCM	XDim,YDim	FLOAT32	None	None	No data=-9999.0 Valid data = 0.0 - 1.0
SDCMCloudHCByHeight Fraction of 1.1km SDCM pixels that are CloudHC (binned into 5 height classes) Derived from the BestWinds SDCM.	XDim,YDim, NAltitudeDim	5 X FLOAT32	None	None	No data=-9999.0 Valid data = 0.0 - 1.0
SDCMCloudLCByHeight Fraction of 1.1km SDCM pixels that are CloudLC (binned into 5 height classes). Derived from the BestWinds SDCM.	XDim,YDim, NAltitudeDim	5 X FLOAT32	None	None	No data=-9999.0 Valid data = 0.0 - 1.0
SDCMClearLCByHeight Fraction of 1.1km SDCM pixels that are ClearLC (NearSurface) (binned into 5 height classes). Derived from the BestWinds SDCM.	XDim,YDim, NAltitudeDim	5 X FLOAT32	None	None	No data=-9999.0 Valid data = 0.0 - 1.0

Field Name Parameter Description	Dimension List	Number Type	Units	Transformation	Flag Values
SDCMClearHCByHeight Fraction of 1.1km SDCM pixels that are ClearHC (binned into 5 height classes). Derived from the BestWinds SDCM.	XDim,YDim, NAltitudeDim	5 X FLOAT32	None	None	No data=-9999.0 Valid data = 0.0 - 1.0
SDCMNoRetrievalByHeight Fraction of 1.1km SDCM pixels that are lacking a retrieval (binned into 5 height classes). Derived from the BestWinds SDCM.	XDim,YDim, NAltitudeDim	5 X FLOAT32	None	None	No data=-9999.0 Valid data = 0.0 - 1.0
RCCM_AnCloudHCByHeight Fraction of 1.1km RCCM_An pixels that are CloudHC (binned into 5 height classes). Derived from the (BestWinds) Feature-Referenced RCCM found in the stereo product.	XDim,YDim, NAltitudeDim	5 X FLOAT32	None	None	No data=-9999.0 Valid data = 0.0 - 1.0
RCCM_AnCloudLCByHeight Fraction of 1.1km RCCM_An pixels that are CloudLC (binned into 5 height classes). Derived from the (BestWinds) Feature-Referenced RCCM found in the stereo product	XDim,YDim, NAltitudeDim	5 X FLOAT32	None	None	No data=-9999.0 Valid data = 0.0 - 1.0
RCCM_AnClearLCByHeight Fraction of 1.1km RCCM_An pixels that are ClearLC (NearSurface) (binned into 5 height classes). Derived from the (BestWinds) Feature-Referenced RCCM found in the stereo product	XDim,YDim, NAltitudeDim	5 X FLOAT32	None	None	No data=-9999.0 Valid data = 0.0 - 1.0
RCCM_AnClearHCByHeight Fraction of 1.1km RCCM_An pixels that are ClearHC (binned into 5 height classes). Derived from the (BestWinds) Feature-Referenced RCCM found in the stereo product	XDim,YDim, NAltitudeDim	5 X FLOAT32	None	None	No data=-9999.0 Valid data = 0.0 - 1.0

Field Name Parameter Description	Dimension List	Number Type	Units	Transformation	Flag Values
RCCM_AnNoRetrieval ByHeight Fraction of 1.1km RCCM_An pixels that are lacking a retrieval (binned into 5 height classes). Derived from the (BestWinds) Feature-Referenced RCCM found in the stereo product	XDim,YDim, NAltitudeDim	5 X FLOAT32	None	None	No data=-9999.0 Valid data = 0.0 - 1.0
ASCMCloudHCByHeight Fraction of 1.1km ASCM pixels that are CloudHC (binned into 5 height classes).	XDim,YDim, NAltitudeDim	5 X FLOAT32	None	None	No data=-9999.0 Valid data = 0.0 - 1.0
ASCMCloudLCByHeight Fraction of 1.1km ASCM pixels that are CloudLC (binned into 5 height classes).	XDim,YDim, NAltitudeDim	5 X FLOAT32	None	None	No data=-9999.0 Valid data = 0.0 - 1.0
ASCMClearLCByHeight Fraction of 1.1km ASCM pixels that are ClearLC (NearSurface) (binned into 5 height classes).	XDim,YDim, NAltitudeDim	5 X FLOAT32	None	None	No data=-9999.0 Valid data = 0.0 - 1.0
ASCMClearHCByHeight Fraction of 1.1km ASCM pixels that are ClearHC (binned into 5 height classes).	XDim,YDim, NAltitudeDim	5 X FLOAT32	None	None	No data=-9999.0 Valid data = 0.0 - 1.0
ASCMNoRetrievalByHeight Fraction of 1.1km ASCM pixels that are lacking a retrieval (binned into 5 height classes).	XDim,YDim, NAltitudeDim	5 X FLOAT32	None	None	No data=-9999.0 Valid data = 0.0 - 1.0
PrelimSDCMCloudHCBy- Height Fraction of 1.1km Preliminary SDCM pixels that are CloudHC (binned into 5 height classes) Derived from the BestWinds PrelimSDCM.	XDim,YDim, NAltitudeDim	5 X FLOAT32	None	None	No data=-9999.0 Valid data = 0.0 - 1.0
PrelimSDCMCloudLCByHeight Fraction of 1.1km Preliminary SDCM pixels that are CloudLC (binned into 5 height classes). Derived from the BestWinds PrelimSDCM.	XDim,YDim, NAltitudeDim	5 X FLOAT32	None	None	No data=-9999.0 Valid data = 0.0 - 1.0

Field Name Parameter Description	Dimension List	Number Type	Units	Transformation	Flag Values
PrelimSDCMClearLCByHeight Fraction of 1.1km Preliminary SDCM pixels that are ClearLC (NearSurface) (binned into 5 height classes). Derived from the BestWinds PrelimSDCM.	XDim,YDim, NAltitudeDim	5 X FLOAT32	None	None	No data=-9999.0 Valid data = 0.0 - 1.0
PrelimSDCMClearHCByHeight Fraction of 1.1km Preliminary SDCM pixels that are ClearHC (binned into 5 height classes). Derived from the BestWinds PrelimSDCM.	XDim,YDim, NAltitudeDim	5 X FLOAT32	None	None	No data=-9999.0 Valid data = 0.0 - 1.0
PrelimSDCMNoRetrievalBy-Height Fraction of 1.1km Preliminary SDCM pixels that are lacking a retrieval (binned into 5 height classes). Derived from the BestWinds PrelimSDCM.	XDim,YDim, NAltitudeDim	5 X FLOAT32	None	None	No data=-9999.0 Valid data = 0.0 - 1.0

7.5.7 Per-grid QA Metadata

Table 7-14: Per-grid QA Metadata for Cloud Classifier Products.

Data Field Name	Data Type	Field Dimensions	Valid Range
SwathQaGlobal: Swath-level Constructs			
NNonFillSubregions	INT32	--	0 - 2272
NNonFillSolarOblique	INT32	--	0 - 2272
Block-level Constructs			
BlockNumber	INT32	--	1 - 180
ValidRecord	UINT8	--	0, 1
TPGeomDataQuallnd	FLOAT64	NCAM	-1 - 1
NSubAscmNR	INT32	--	0 -65,536
NSubAscmOverride	INT32	--	0 - 65,536

7.6 MISR LEVEL 2 MIL2TCAL CLOUD ALBEDO PRODUCT

7.6.1 File Metadata Description

Table 7-15: File Metadata for Cloud Albedo Product Files.

File Metadata Field Name	Definition	Data Type	Units	Valid Range
Path_number	Orbit path number	INT32	N/A	1-233
AGP_version_id	Version identifier for AGP	INT32	N/A	2
DID_version_id	Version Identifier for DID (DTED Digital Terrain Elevation Dataset] Intermediate Dataset)	INT32	N/A	4
Number_blocks	Total number of blocks	INT32	N/A	1-180
Ocean_blocks_size	Ocean_blocks.number dimension	INT32	N/A	1-180
Ocean_blocks.count	Total number of blocks containing entirely ocean radiances	INT32	N/A	1-180
Ocean_blocks.numbers	List of block numbers containing entirely ocean radiances	180 x INT32	N/A	1-180
SOM_parameters.som_ellipsoid.a	Semimajor axis of ellipsoid	FLOAT64	meters	WGS84 ellipsoid (6.3781370E+06)
SOM_parameters.som_ellipsoid.e2	Eccentricity of ellipsoid squared	FLOAT64	N/A	WGS84 ellipsoid (6.6943480E-03)
SOM_parameters.som_orbit.aprime	Semimajor axis of orbit	FLOAT64	meters	1.0
SOM_parameters.som_orbit.eprime	Eccentricity of orbit	FLOAT64	N/A	1.0
SOM_parameters.som_orbit.gama	Longitude of perigee	FLOAT64	radians	1.0
SOM_parameters.som_orbit.nrev	Number of revolutions per ground track repeat cycle	INT32	N/A	233
SOM_parameters.som_orbit.ro	Radius of circular orbit	FLOAT64	meters	7.0780408E+06
SOM_parameters.som_orbit.i	Inclination of orbit (degrees)	FLOAT64	radians	1.7157253
SOM_parameters.som_orbit.P2P1	Ratio of time of revolution over length of Earth rotation/orbit	FLOAT64	N/A	6.8666667E-02

File Metadata Field Name	Definition	Data Type	Units	Valid Range
SOM_parameters.som_orbit.lambda0	Geodetic longitude of ascending node at time 0 (degrees)	FLOAT64	radians	-2pi: 2pi
Origin_block.ulc.x	SOM X coordinate (in meters) of the upper left corner of the first block	FLOAT64	meters	
Origin_block.ulc.y	SOM Y coordinate (in meters) of the upper left corner of the first block	FLOAT64	meters	
Origin_block.lrc.x	SOM X coordinate (in meters) of the lower right corner of the first block	FLOAT64	meters	
Origin_block.lrc.y	SOM Y coordinate (in meters) of the lower right corner of the first block	FLOAT64	meters	
Start_block	The block number in the AGP which corresponds to the first block in this file containing data.	INT32	N/A	1 - 180 Start_block < End block
End_block	The block number in the AGP which corresponds to the last block in this file containing data.	INT32	N/A	1 - 180 Start_block < End block
Cam_mode	Indicates whether the data in this grid file was obtained in MISR global mode or local mode.	INT32	N/A	0-1 1 = global 0 = local
Num_local_modes	The number of MISR local mode acquisitions contained in this file.	INT32	N/A	0-6 0 if data is global mode
Local_mode_site_name	The geographical name of the first local mode site contained in this file.	CHAR8	N/A	string up to 12 characters in length, including null
Orbit_QA	Indication of the overall quality of the orbit data based on analysis of quality flags in the spacecraft attitude and ephemeris data. Geolocation accuracy may be impaired for orbits with poor quality orbit data.	FLOAT32	N/A	-9999.0 = NoRetrieval, -1.0 = Poor, 0.0 = Nominal

7.6.2 Per-grid Metadata Description

Table 7-16: Per-grid Metadata for Cloud Albedo Product Files.

Common Grid Metadata	Definition	Data Type	Valid Values
Block_size.resolution_x	Resolution of block x dimension in meters	INT32	2200, 17600, 35200

Common Grid Metadata	Definition	Data Type	Valid Values
Block_size.resolution_y	Resolution of block y dimension in meters	INT32	2200, 17600, 35200
Block_size.size_x	Block x dimension	INT32	64, 8, 4
Block_size.size_y	Block y dimension	INT32	256, 32, 16

7.6.3 Per-block Metadata Description

Table 7-17: Per-block Metadata for Cloud Albedo Product Files.

PerBlockMetadataCommon	Definition	Data Type	Valid Values
Block_number	Current block number	INT32	1-180
Ocean_flag	Flag signalling whether the block contains entirely ocean radiances	INT8	0 = block has no ocean or is a mix of ocean and land 1 = block is entirely ocean
Block_coor_ulc_som_meter.x	Upper left corner SOM block x coordinate in meters	FLOAT64	
Block_coor_ulc_som_meter.y	Upper left corner SOM block y coordinate in meters	FLOAT64	
Block_coor_lrc_som_meter.x	Lower right corner SOM block x coordinate in meters	FLOAT64	
Block_coor_lrc_som_meter.y	Lower right corner SOM block y coordinate in meters	FLOAT64	
Data_flag	Flag signalling whether the block contains entirely fill data	INT8	0 = block contains entirely fill data 1 = block contains valid data

Common Per Block Metadata	Definition	Data Type	Valid Values
Geometric DQI	Geometric Data Quality Indicator copied from the L1B2 Terrain-projected parameter file.	INT32	-1 to 1

PerBlockMetadataTime	Definition	Data Type	Valid Values
BlockCenterTime	Imaging time for the block center (AN Camera) in UTC.	CHAR8	

7.6.4 Per-line Metadata Description

None.

7.6.5 Per-pixel Metadata Description

None.

7.6.6 Grid Data Set Descriptions

In order to minimize storage for the TOA/Cloud Product, many logical parameters will be packed so that each bit represents a logical value, or some number of bits within a byte or word represent a flag value.

To facilitate the interpretation of scientific data, floating point values are not scaled. Floating point values, and some integer values, may take on a flag value indicating invalid data. Currently, there is only a single flag value of -9999.0, representing missing floating point data. Missing integer data may be represented either by a value of 0 (for flag data) or -9999 (for measured data) or -99 (for measured byte integer data). Note that we may later add more flag values to distinguish the reason that the data are missing (e.g. never computed, arithmetic error, overflow, etc.).

Table 7-18: Cloud Albedo Product Field Dimension Descriptions

Dimension	Description	Valid Values
SOMBlockDim	<i>SOMBlockDim</i> is the number of SOM blocks in the file. The slowest-varying dimension is implicitly the SOM block dimension. It is not shown in the tables below.	this can vary, with a typical value being approximately 140
XDim	<i>XDim</i> is the number of lines in a block. The x dimension direction is identical to the standard SOM x dimension.	128 for 1.1 km parameters 64 for 2.2 km parameters 8 for 17.6 km parameters 4 for 35.2 km parameters 2 for 70.4 km parameters



Table 7-18: Cloud Albedo Product Field Dimension Descriptions (Continued)

Dimension	Description	Valid Values
YDim	YDim is the number of samples in a block. The y dimension direction is identical to the standard SOM y dimension.	512 for 1.1 km parameters 256 for 2.2 km parameters 32 for 17.6 km parameters 16 for 35.2 km parameters 8 for 70.4 km parameters
NCamDim	NCamDim distinguishes the individual nine cameras	1-9. DF=1, CF=2, BF=3, AF=4, AN=5, AA=6, BA=7, CA=8, DA=9
NBandDim	NBandDim distinguishes the individual four camera bands	1-4. Blue=1, Green=2, Red=3, NIR=4.

Table 7-19: Cloud Albedo Product Grid Dataset Descriptions.

Field Name Parameter Description	Dimension List	Number Type	Units	Transformation	Flag Values
ReflectingLevelParameters_2.2_km : (Spatial Resolution: 2.2 km x 2.2 km, XDim = 64, YDim = 256)					
AlbedoLocal Local TOA albedo (4 bands)	XDim,YDim, NBandDim	4 X FLOAT32	None	None	No data=-9999.0
NumUnobscuredTop Number of unobscured top pixels (9 angles)	XDim,YDim, NCamDim	9 X INT8	None	None	No data=-99 or -98
BRFTop_Mean Top BRF referenced to RLRA. (4 bands X 9 angles)	XDim,YDim, NCamDim, NBandDim	4 X 9 X FLOAT32	None	None	No data=-9999.0 pr - 9998.0
FlagCamFillTop Source Flag for Top BRF's indicating whether or not BRF was filled-in or not. (4 bands x 9 angles)	XDim,YDim, NCamDim, NBandDim	4 X 9 X UINT8	None	None	0 = Not-Filled-In or no data, 1 = Filled-In
NumUnobscuredSide Number of unobscured side pixels (9 angles)	XDim,YDim, NCamDim	9 X INT16	None	None	No data=-9999 or -9998
BRFSide_Mean Side BRF referenced to RLRA (4 bands X 9 angles)	XDim,YDim, NCamDim, NBandDim	4 X 9 X FLOAT32	None	None	No data=-9999.0 or - 9998.0
FlagCamFillSide Source Flag for Side BRF's indicating whether or not BRF was filled-in or not. (4 bands x 9 angles)	XDim,YDim, NCamDim, NBandDim	4 X 9 X UINT8	None	None	0 = Not-Filled-In or no data, 1 = Filled-In

Field Name Parameter Description	Dimension List	Number Type	Units	Transformation	Flag Values
LocalAlbedoMethodandSAW Reason Local albedo contribution methodology/Reasons for solid angle weighting (4 bands X 9 angles)	XDim,YDim, NCamDim, NBandDim	4 X 9 X UINT8	None	None	No Retrieval=0; Cloudy Deterministic=1; Cloudy Stochastic=2; Clear Deterministic=3; Solid Angle Weighting SAW - sun overhead=4; SAW (nadir camera)=5; SAW - Cloudy criteria not met=7; SAW - Clear, too few angles to try=8; SAW - Clear, too few angles to match=9; SAW - Clear angle doesn't match=10; SAW -AZM undetermined=11; No Df/Da camera data=12; No contri- bution found = 15;
GLDVStdDevTotal First top texture index computed from the standard deviation of all BRF's assigned to the top of a given RLRA column. (9 angles).	XDim,YDim, NCamDim	9 X FLOAT32	None	None	No data=-9999.0
GLDVStdDevAlong Second top texture index computed from the along-track standard deviation of BRF's assigned to the top of a given RLRA column. (9 angles)	XDim,YDim, NCamDim	9 X FLOAT32	None	None	No data=-9999.0
GLDVStdDevAcross Third top texture index computed from the cross-track standard deviation of BRF's assigned to the top of a given RLRA column. (9 angles)	XDim,YDim, NCamDim	9 X FLOAT32	None	None	No data=-9999.0
RLRAInterpolated The RLRA used in the reprojection of the BRF's up to the RLRA after interpolation to fill in all the missing values.	XDim,YDim	FLOAT32	metres	None	No data = -9999.0

Field Name Parameter Description	Dimension List	Number Type	Units	Transformation	Flag Values
CloudyClearDesignation Cloudy/clear and cloud phase designation	XDim,YDim	UINT8	None	None	No Retrieval/ Undetermined=0; Clear=1; Cloudy: liquid cloud phase=2; Cloudy:ice cloud phase=3; Cloudy:unknown cloud phase=4.
HighCloudIndicator High cloud indicator	XDim,YDim	UINT8	None	None	No Retrieval=0; High Cloud Present=1; High Cloud Not Present=2; High Cloud Undeter- mined=3
CloudyClearSource cloud phase source	XDim,YDim	UINT8	None	None	No Retrieval=0; MODIS=1; TASC: other out-of- bounds=2; TASC; other not available=3
CloudLiquidProbability Probability that the cloud phase is liquid.	XDim,YDim	UINT8	None	None	0-100, No data = -99
CloudTopTemperature Cloud-top temperature	XDim,YDim	FLOAT32	Deg. Celcius	None	No data=-9999.0
FlagCloudPhaseOverride Cloud phase override flag (8 off-nadir angles, 4 bands)	XDim,YDim, NBandDim	4 X UINT8	None	Pack lowest bit of override flag for all 8 off- nadir cameras into bits 1-8	None
CloudTexture Texture of the cloud-top as determined by looking at the GLDVStDevTotal.	XDim,YDim	UINT8	None	None	No Retrieval=0; Homogeneous=1; Heterogeneous=2
HomogeneityReferenceCam Homogeneity reference camera used in determining the CloudTexture flag.	XDim,YDim	UINT8	None	None	No Retrieval=0; Bf=3; Af=4; An=5; Aa=6; Ba=7
SurfaceType Surface type	XDim,YDim	UINT8	None	None	No Retrieval=0; Water=1; Vegetated Land=2; Non- Vegetated Land=3; Snow/ice = 4
CSSCSurfaceType Corresponding Surface Type from the CloudScreeningSurface Classification Dataset.	XDim,YDim	INT16	None	None	No data = -9999, 0 = Water 1-1580 = Land

Field Name Parameter Description	Dimension List	Number Type	Units	Transformation	Flag Values
IndexSolarZenith Solar zenith angle index	XDim,YDim	INT8	None	None	No Retrieval=-99, 1-15.
IndexViewingZenith View zenith angle index for each camera	XDim,YDim, NCamDim	9 x INT8	None	None	No Retrieval=-99, 1-2.
IndexBlueAltitude Blue band altitude bin index	XDim,YDim	INT8	None	None	No Retrieval=-99, 1-4.
IndexGreenAltitude Green band altitude bin index	XDim,YDim	INT8	None	None	No Retrieval=-99, 1-4.
IndexBrightness Brightness index, 9 cameras	XDim,YDim, NCamDim	9 X INT8	None	None	No Retrieval=-99, 1-13.
IndexIgloo Igloo index (off-nadir cameras)	XDim,YDim	UINT8	None	Pack lowest bit from each camera into 8 bits	No Retrieval = 0, Forward Scatter = 1, Backward Scatter = 2
RelativeAzimuthBinInterpolator Relative azimuth angle bin + interpolation fraction.	XDim,YDim, NCamDim	9 X FLOAT32	None	Integer portion = lower of 2 surrounding relative azimuth angle bins. Remainder = interpolation fraction between this bin and the higher one.	No Retrieval = -9999.0 0.0 - 7.0
ClearSkyR0 Clear sky local albedo R0 parameter (4 bands)	XDim,YDim, NBandDim	4 X FLOAT32	None	None	No data=-9999.0
ClearSkyKappa Clear sky local albedo Kappa parameter (4 bands)	XDim,YDim, NBandDim	4 X FLOAT32	None	None	No data=-9999.0
ClearSkyBeta Clear sky local albedo Beta parameter (4 bands)	XDim,YDim, NBandDim	4 X FLOAT32	None	None	No data=-9999.0
ClearSkyCameras Channels used in clear-sky fits (4 bands X 9 angles)	XDim,YDim, NBandDim	4 X UINT16	None	Pack lowest bit from each camera into lowest 9 bits, for each band	None
ClearSkyChiSquare Camera-averaged chi-square for clear-sky fits (4 bands)	XDim,YDim, NBandDim	4 X FLOAT32	None	None	No data=-9999.0
GeometricParameters_17.6_km					

Field Name Parameter Description	Dimension List	Number Type	Units	Transformation	Flag Values
SolarZenithAngle Solar zenith angle	XDim,YDim	FLOAT32	degs	None	No data=-9999.0
ViewZenithAngle View zenith angle (9 angles)	XDim,YDim, NCamDim	9 X FLOAT32	degs	None	No data=-9999.0
RelativeAzimuthAngle View-Sun relative azimuth angle (9 angles)	XDim,YDim, NCamDim	9 X FLOAT32	degs	None	No data=-9999.0
AlbedoParameters_35.2_km:					
AlbedoExpansive Expansive albedo (4 bands)	XDim,YDim, NBandDim	4 X FLOAT32	None	None	No data=-9999.0
AlbedoRestrictive Total restrictive albedo (4 bands)	XDim,YDim, NBandDim	4 X FLOAT32	None	None	No data=-9999.0
SolarZenithCosineRegional Regional mean solar zenith angle cosine	XDim,YDim	FLOAT32	None	None	No data=-9999.0
NumLocalAlbedoGood Number of pixels with successful calculation of local albedo.	XDim,YDim, NBandDim	4 x INT16	None	None	No data = -9999 Valid data = 0 - 256
NumLocalAlbedoGood NoCamFill Number of pixels that did not contain any filled-in BRF's with successful calculation of local albedo.	XDim,YDim, NBandDim	4 x INT16	None	None	No data = -9999 Valid data = 0 - 256
LocalAlbedo_Mean Average value of local albedo over this region.	XDim,YDim, NBandDim	4 x FLOAT32	None	None	No data = -9999.0
LocalAlbedo_StdDev Standard deviation of all local albedos in this region.	XDim,YDim, NBandDim	4 x FLOAT32	None	None	No data = -9999.0
LocalAlbedoNoCamFill_Mean Average value of all local albedo pixels which did not contain any filled-in BRF's.	XDim,YDim, NBandDim	4 x FLOAT32	None	None	No data = -9999.0
LocalAlbedoNoCamFill_StdDev Standard deviation of all local albedos in this region that did not contain any filled-in BRF's.	XDim,YDim, NBandDim	4 x FLOAT32	None	None	No data = -9999.0
NumDeterministicSucceeded Number of pixels for which deterministic modelling of a local albedo component succeeded, tabulated separately for each band and camera.	XDim,YDim, NBandDim, NCamDim	4 x 9 x INT16	None	None	No data = -9999 Valid data = 0 - 256

Field Name Parameter Description	Dimension List	Number Type	Units	Transformation	Flag Values
NumDeterministicFailed Number of pixels for which deterministic modelling of a local albedo component failed, tabulated separately for each band and camera.	XDim,YDim, NBandDim, NCamDim	4 x 9 x INT16	None	None	No data = -9999 Valid data = 0 - 256
NumStochasticSucceeded Number of pixels for which stochastic modelling of a local albedo component succeeded, tabulated separately for each band and camera.	XDim,YDim, NBandDim, NCamDim	4 x 9 x INT16	None	None	No data = -9999 Valid data = 0 - 256
NumStochasticFailed Number of pixels for which stochastic modelling of a local albedo component failed, tabulated separately for each band and camera.	XDim,YDim, NBandDim, NCamDim	4 x 9 x INT16	None	None	No data = -9999] Valid data = 0 - 256
RestrictiveAlbedoTop Restrictive albedo top-leaving term (4 bands)	XDim,YDim, NBandDim	4 X FLOAT32	None	None	No data=-9999.0
RestrictiveAlbedoSide Side-leaving contribution at each angle (4 bands X 9 angles)	XDim,YDim, NBandDim, NCamDim	4 X 9 X FLOAT32	None	None	No data=-9999.0
NumSubRestrictiveAlbedoTop Number of subregions contributing to top-leaving term (4 bands)	XDim,YDim, NBandDim	4 X UINT16	None	None	No data=65533 Valid data = 0 - 256
NumSubRestrictiveAlbedoSide Number of subregions contributing to side-leaving term (4 bands X 9 angles)	XDim,YDim, NBandDim, NCamDim	4 X 9 X UINT16	None	None	No data=65533 Valid data = 0 - 256
FlagRestrictiveAlbedoSide Camera angles contributing to side-leaving term (4 bands X 9 angles)	XDim,YDim	4 X UINT16	None	Pack lowest bit from each camera into lowest 9 bits, for each band	None.
NumSubExpansiveConsidered Number of subregions considered during summation	XDim,YDim	INT32	None	None	No data=-9999 Block not processed=-8888
NumSubExpansiveUsed Number of subregions actually included in summation (4 bands)	XDim,YDim, NBandDim	4 X INT32	None	None	No data=-9999 or -8888 (block not processed)

Field Name Parameter Description	Dimension List	Number Type	Units	Transformation	Flag Values
NumSubExpansiveMissBRFTop Number of subregions eliminated due to missing top-leaving term (4 bands)	XDim,YDim, NBandDim	4 X INT32	None	None	No data=-9999 or -8888 (block not processed)
NumSubExpansiveMissBRFSide Number of subregions eliminated due to missing side-leaving term (4 bands)	XDim,YDim, NBandDim	4 X INT32	None	None	No data=-9999 or -8888 (block not processed)
NumSubExpansiveBadObscTop Number of subregions eliminated due to obscured top-leaving term (4 bands)	XDim,YDim, NBandDim	4 X INT32	None	None	No data=-9999 or -8888 (block not processed)
NumSubExpansiveBadObscSide Number of subregions eliminated due to obscured side-leaving term (4 bands)	XDim,YDim, NBandDim	4 X INT32	None	None	No data=-9999 or -8888 (block not processed)
NumSubExpansiveOblique Number of subregions eliminated due to sun angle too oblique	XDim,YDim	INT32	None	None	No data=-9999 Block not processed=-8888
FractionExpansiveClearHighConf Fractional area contributing to the expansive albedo classified as Clear HC	XDim,YDim	FLOAT32	None	None	No data=-9999.0
FractionExpansiveClearLowConf Fractional area contributing to the expansive albedo classified as Clear LC	XDim,YDim	FLOAT32	None	None	No data=-9999.0

7.6.7 Per-grid QA Metadata

Table 7-20: Per-grid QA Metadata for Cloud Albedo Products.

Data Field Name	Data Type	Field Dimensions	Valid Range
SwathQaGlobal: Swath-level Constructs			
NNonFillTopBRF	INT32	NBAND	0 - 2,326,528
NSuccLocalAlbedo	INT32	NBAND	0 - 2,326,528
NCldySkyContribLocalAlbedo	INT32	NBAND	0 - 2,326,528
NClrSkyContribLocalAlbedo	INT32	NBAND	0 - 2,326,528
NSAWOnlyLocalAlbedo	INT32	NBAND	0 - 2,326,528



Data Field Name	Data Type	Field Dimensions	Valid Range
NRLRASubWGoodMODISCIdPhase	INT32	--	0 - 2,326,528
NRLRASubWBadMODISCIdPhase	INT32	--	0 - 2,326,528
NRLRASubWNAMEMODISCIdPhase	INT32	--	0 - 2,326,528
NNonFill35kmReg	INT16	NBAND	0 - 9088
NSuccRestAlbedo	INT16	NBAND	0 - 9088
NSuccExpAlbedo	INT16	NBAND	0 - 9088
BlockQaGlobal: Block-level Constructs			
BlockNumber	INT32	--	1 - 180
ValidRecord	UINT8	--	0, 1
TpGeomDataQualInd	FLOAT64	NCAM	-1 - 1
UpLeftCornerLat	FLOAT64	--	-90 - 90
UpLeftCornerLong	FLOAT64	--	-180 - 180
UpRightCornerLat	FLOAT64	--	-90 - 90
UpRightCornerLong	FLOAT64	--	-180 - 180
LowLeftCornerLat	FLOAT64	--	-90 - 90
LowLeftCornerLong	FLOAT64	--	-180 - 180
LowRightCornerLat	FLOAT64	--	-90 - 90
LowRightCornerLong	FLOAT64	--	-180 - 180
NumRtraFilled	INT32	--	0 - 16,384
NumPixSucceedTop	INT32	NCAM	0 - 16,384
NumPixSucceedSider	INT32	NCAM	0 - 16,384
NumPixNoLookVector	INT32	NCAM	0 - 16,384
NumPixNoBrfBlue	INT32	NCAM	0 - 16,384
NumPixNoBrfGreen	INT32	NCAM	0 - 16,384
NumPixNoBrfRed	INT32	NCAM	0 - 16,384
NumPixNoBrfNIR	INT32	NCAM	0 - 16,384
NAZMCIdLiquidPhase	INT16	--	0 - 16,384
NAZMCIdIcePhase	INT16	--	0 - 16,384
NAZMCIdUnknownPhase	INT16	--	0 - 16,384
NAZMCIdr	INT16	--	0 - 16,384
NAZMUndetermined	INT16	--	0 - 16,384

Data Field Name	Data Type	Field Dimensions	Valid Range
NNoFillAZMCIdLiquidPhase	INT16	--	0 - 16,384
NNoFillAZMCIdIcePhase	INT16	--	0 - 16,384
NNoFillAZMCIdUnknownPhase	INT16	--	0 - 16,384
NNoFillAZMCIdr	INT16	--	0 - 16,384
NNoFillAZMUndetermined	INT16	--	0 - 16,384
NAZMCIdUnknownOverridWLIquid	INT16	--	0 - 16,384
NSnowIceSub	INT16	--	0 - 16,384
NWaterSub	INT16	--	0 - 16,384
NVegetated	INT16	--	0 - 16,384
NNonVegetatedLandSub	INT16	--	0 - 16,384
NAZMCIdSnowIceSub	INT16	--	0 - 16,384
NAZMCIdWaterSub	INT16	--	0 - 16,384
NAZMCIdVegetatedLandSub	INT16	--	0 - 16,384
NAZMCIdNonVegetatedLandSub	INT16	--	0 - 16,384
NNoFillAZMCIdSnowIceSub	INT16	--	0 - 16,384
NNoFillAZMCIdWaterSub	INT16	--	0 - 16,384
NNoFillAZMCIdVegetatedLandSub	INT16	--	0 - 16,384
NNoFillAZMCIdNonVegetatedLandSub	INT16	--	0 - 16,384
NHighCIdPresentSub	INT16	--	0 - 16,384
NHighCIdNotPresentSub	INT16	--	0 - 16,384
NHighCIdUndeterminedSub	INT16	--	0 - 16,384
NSubWHomogenRefCamAn	INT16	--	0 - 16,384
NSubWHomogenRefCamAf	INT16	--	0 - 16,384
NSubWHomogenRefCamAa	INT16	--	0 - 16,384
NSubWHomogenRefCamBf	INT16	--	0 - 16,384
NSubWHomogenRefCamBa	INT16	--	0 - 16,384
NSubWHomogenRefCamNA	INT16	--	0 - 16,384
NSubHomogeneousTexture	INT16	--	0 - 16,384
NSubHeterogeneousTexture	INT16	--	0 - 16,384
NSubTextureNA	INT16	--	0 - 16,384
NBlueSubNoLocalAttempted	INT16	NCAM	0 - 16,384

Data Field Name	Data Type	Field Dimensions	Valid Range
NBlueSubLocalUsingDetermCld	INT16	NCAM	0 - 16,384
NBlueSubLocalUsingStochastCld	INT16	NCAM	0 - 16,384
NBlueSubLocalUsingDetermClr	INT16	NCAM	0 - 16,384
NBlueSubLocalUsingSAW	INT16	NCAM	0 - 16,384
NBlueSubLocalNotSucc	INT16	NCAM	0 - 16,384
NGreenSubNoLocalAttempted	INT16	NCAM	0 - 16,384
NGreenSubLocalUsingDetermCld	INT16	NCAM	0 - 16,384
NGreenSubLocalUsingStochastCld	INT16	NCAM	0 - 16,384
NGreenSubLocalUsingDetermClr	INT16	NCAM	0 - 16,384
NGreenSubLocalUsingSAW	INT16	NCAM	0 - 16,384
NGreenSubLocalNotSucc	INT16	NCAM	0 - 16,384
NRedSubNoLocalAttempted	INT16	NCAM	0 - 16,384
NRedSubLocalUsingDetermCld	INT16	NCAM	0 - 16,384
NRedSubLocalUsingStochastCld	INT16	NCAM	0 - 16,384
NRedSubLocalUsingDetermClr	INT16	NCAM	0 - 16,384
NRedSubLocalUsingSAW	INT16	NCAM	0 - 16,384
NRedSubLocalNotSucc	INT16	NCAM	0 - 16,384
NNIRSubNoLocalAttempted	INT16	NCAM	0 - 16,384
NNIRSubLocalUsingDetermCld	INT16	NCAM	0 - 16,384
NNIRSubLocalUsingStochastCld	INT16	NCAM	0 - 16,384
NNIRSubLocalUsingDetermClr	INT16	NCAM	0 - 16,384
NNIRSubLocalUsingSAW	INT16	NCAM	0 - 16,384
NNIRSubLocalNotSucc	INT16	NCAM	0 - 16,384
NBlueSubSAWOblique	INT16	NCAM	0 - 16,384
NBlueSubSAWNadirView	INT16	NCAM	0 - 16,384
NBlueSubSAWMissingBRFs	INT16	NCAM	0 - 16,384
NBlueSubSAWCldyModelFailed	INT16	NCAM	0 - 16,384
NBlueSubSAWTooFewAngAttemptClr	INT16	NCAM	0 - 16,384
NBlueSubSAWTooFewAngMatchClr	INT16	NCAM	0 - 16,384
NBlueSubSAWNotThisAngleMatchClr	INT16	NCAM	0 - 16,384
NBlueSubSAWSceneUnclassifiable	INT16	NCAM	0 - 16,384



Data Field Name	Data Type	Field Dimensions	Valid Range
NBlueSubSAWNolglooCamAvail	INT16	NCAM	0 - 16,384
NGreenSubSAWOblique	INT16	NCAM	0 - 16,384
NGreenSubSAWNadirView	INT16	NCAM	0 - 16,384
NGreenSubSAWMissingBRFs	INT16	NCAM	0 - 16,384
NGreenSubSAWCldyModelFailed	INT16	NCAM	0 - 16,384
NGreenSubSAWTooFewAngAttemptClr	INT16	NCAM	0 - 16,384
NGreenSubSAWTooFewAngMatchClr	INT16	NCAM	0 - 16,384
NGreenSubSAWNotThisAngleMatchClr	INT16	NCAM	0 - 16,384
NGreenSubSAWSceneUnclassifiable	INT16	NCAM	0 - 16,384
NGreenSubSAWNolglooCamAvail	INT16	NCAM	0 - 16,384
NRedSubSAWOblique	INT16	NCAM	0 - 16,384
NRedSubSAWNadirView	INT16	NCAM	0 - 16,384
NRedSubSAWMissingBRFs	INT16	NCAM	0 - 16,384
NRedSubSAWCldyModelFailed	INT16	NCAM	0 - 16,384
NRedSubSAWTooFewAngAttemptClr	INT16	NCAM	0 - 16,384
NRedSubSAWTooFewAngMatchClr	INT16	NCAM	0 - 16,384
NRedSubSAWNotThisAngleMatchClr	INT16	NCAM	0 - 16,384
NRedSubSAWSceneUnclassifiable	INT16	NCAM	0 - 16,384
NRedSubSAWNolglooCamAvail	INT16	NCAM	0 - 16,384
NNIRSubSAWOblique	INT16	NCAM	0 - 16,384
NNIRSubSAWNadirView	INT16	NCAM	0 - 16,384
NNIRSubSAWMissingBRFs	INT16	NCAM	0 - 16,384
NNIRSubSAWCldyModelFailed	INT16	NCAM	0 - 16,384
NNIRSubSAWTooFewAngAttemptClr	INT16	NCAM	0 - 16,384
NNIRSubSAWTooFewAngMatchClr	INT16	NCAM	0 - 16,384
NNIRSubSAWNotThisAngleMatchClr	INT16	NCAM	0 - 16,384
NNIRSubSAWSceneUnclassifiable	INT16	NCAM	0 - 16,384
NNIRSubSAWNolglooCamAvail	INT16	NCAM	0 - 16,384
MeanSolarZenAngleCos	FLOAT32	--	0.0 - 1.0
BlockQaGlobalHist: Block-level Histograms			
LoBndLocAlbBlue	FLOAT32	--	

Data Field Name	Data Type	Field Dimensions	Valid Range
HiBndLocAlbBlue	FLOAT32	--	
NBinsLocAlbBlue	INT16	--	0 - 22
HistLocAlbBlue	INT16	22	0 - 16,384
LoBndLocAlbBlueNoFill	FLOAT32	--	
HiBndLocAlbBlueNoFill	FLOAT32	--	
NBinsLocAlbBlueNoFill	INT16	--	0 - 22
HistLocAlbBlueNoFill	INT16	22	0 - 16,384
LoBndLocAlbClearBlue	FLOAT32	--	
HiBndLocAlbClearBlue	FLOAT32	--	
NBinsLocAlbClearBlue	INT16	--	0 - 22
HistLocAlbClearBlue	INT16	22	0 - 16,384
LoBndLocAlbClearBlueNoFill	FLOAT32	--	
HiBndLocAlbClearBlueNoFill	FLOAT32	--	
NBinsLocAlbClearBlueNoFill	INT16	--	0 - 22
HistLocAlbClearBlueNoFill	INT16	22	0 - 16,384
LoBndLocAlbCloudBlue	FLOAT32	--	
HiBndLocAlbCloudBlue	FLOAT32	--	
NBinsLocAlbCloudBlue	INT16	--	0 - 22
HistLocAlbCloudBlue	INT16	22	0 - 16,384
LoBndLocAlbCloudBlueNoFill	FLOAT32	--	
HiBndLocAlbCloudBlueNoFill	FLOAT32	--	
NBinsLocAlbCloudBlueNoFill	INT16	--	0 - 22
HistLocAlbCloudBlueNoFill	INT16	22	0 - 16,384
LoBndResAlbBlue	FLOAT32	--	
HiBndResAlbBlue	FLOAT32	--	
NBinsResAlbBlue	INT16	--	0 - 22
HistResAlbBlue	INT16	22	0 - 16,384
LoBndResAlbBlueNoFill	FLOAT32	--	
HiBndResAlbBlueNoFill	FLOAT32	--	
NBinsResAlbBlueNoFill	INT16	--	0 - 22
HistResAlbBlueNoFill	INT16	22	0 - 16,384



Data Field Name	Data Type	Field Dimensions	Valid Range
LoBndExpAlbBlue	FLOAT32	--	
HiBndExpAlbBlue	FLOAT32	--	
NBinsExpAlbBlue	INT16	--	0 - 22
HistExpAlbBlue	INT16	22	0 - 16,384
LoBndLocAlbGreen	FLOAT32	--	
HiBndLocAlbGreen	FLOAT32	--	
NBinsLocAlbGreen	INT16	--	0 - 22
HistLocAlbGreen	INT16	22	0 - 16,384
LoBndLocAlbGreenNoFill	FLOAT32	--	
HiBndLocAlbGreenNoFill	FLOAT32	--	
NBinsLocAlbGreenNoFill	INT16	--	0 - 22
HistLocAlbGreenNoFill	INT16	22	0 - 16,384
LoBndLocAlbClearGreen	FLOAT32	--	
HiBndLocAlbClearGreen	FLOAT32	--	
NBinsLocAlbClearGreen	INT16	--	0 - 22
HistLocAlbClearGreen	INT16	22	0 - 16,384
LoBndLocAlbClearGreenNoFill	FLOAT32	--	
HiBndLocAlbClearGreenNoFill	FLOAT32	--	
NBinsLocAlbClearGreenNoFill	INT16	--	0 - 22
HistLocAlbClearGreenNoFill	INT16	22	0 - 16,384
LoBndLocAlbCloudGreen	FLOAT32	--	
HiBndLocAlbCloudGreen	FLOAT32	--	
NBinsLocAlbCloudGreen	INT16	--	0 - 22
HistLocAlbCloudGreen	INT16	22	0 - 16,384
LoBndLocAlbCloudGreenNoFill	FLOAT32	--	
HiBndLocAlbCloudGreenNoFill	FLOAT32	--	
NBinsLocAlbCloudGreenNoFill	INT16	--	0 - 22
HistLocAlbCloudGreenNoFill	INT16	22	0 - 16,384
LoBndResAlbGreen	FLOAT32	--	
HiBndResAlbGreen	FLOAT32	--	
NBinsResAlbGreen	INT16	--	0 - 22



Data Field Name	Data Type	Field Dimensions	Valid Range
HistResAlbGreen	INT16	22	0 - 16,384
LoBndResAlbGreenNoFill	FLOAT32	--	
HiBndResAlbGreenNoFill	FLOAT32	--	
NBinsResAlbGreenNoFill	INT16	--	0 - 22
HistResAlbGreenNoFill	INT16	22	0 - 16,384
LoBndExpAlbGreen	FLOAT32	--	
HiBndExpAlbGreen	FLOAT32	--	
NBinsExpAlbGreen	INT16	--	0 - 22
HistExpAlbGreen	INT16	22	0 - 16,384
LoBndLocAlbRed	FLOAT32	--	
HiBndLocAlbRed	FLOAT32	--	
NBinsLocAlbRed	INT16	--	0 - 22
HistLocAlbRed	INT16	22	0 - 16,384
LoBndLocAlbRedNoFill	FLOAT32	--	
HiBndLocAlbRedNoFill	FLOAT32	--	
NBinsLocAlbRedNoFill	INT16	--	0 - 22
HistLocAlbRedNoFill	INT16	22	0 - 16,384
LoBndLocAlbClearRed	FLOAT32	--	
HiBndLocAlbClearRed	FLOAT32	--	
NBinsLocAlbClearRed	INT16	--	0 - 22
HistLocAlbClearRed	INT16	22	0 - 16,384
LoBndLocAlbClearRedNoFill	FLOAT32	--	
HiBndLocAlbClearRedNoFill	FLOAT32	--	
NBinsLocAlbClearRedNoFill	INT16	--	0 - 22
HistLocAlbClearRedNoFill	INT16	22	0 - 16,384
LoBndLocAlbCloudRed	FLOAT32	--	
HiBndLocAlbCloudRed	FLOAT32	--	
NBinsLocAlbCloudRed	INT16	--	0 - 22
HistLocAlbCloudRed	INT16	22	0 - 16,384
LoBndLocAlbCloudRedNoFill	FLOAT32	--	
HiBndLocAlbCloudRedNoFill	FLOAT32	--	



Data Field Name	Data Type	Field Dimensions	Valid Range
NBinsLocAlbCloudRedNoFill	INT16	--	0 - 22
HistLocAlbCloudRedNoFill	INT16	22	0 - 16,384
LoBndResAlbRed	FLOAT32	--	
HiBndResAlbRed	FLOAT32	--	
NBinsResAlbRed	INT16	--	0 - 22
HistResAlbRed	INT16	22	0 - 16,384
LoBndResAlbRedNoFill	FLOAT32	--	
HiBndResAlbRedNoFill	FLOAT32	--	
NBinsResAlbRedNoFill	INT16	--	0 - 22
HistResAlbRedNoFill	INT16	22	0 - 16,384
LoBndExpAlbRed	FLOAT32	--	
HiBndExpAlbRed	FLOAT32	--	
NBinsExpAlbRed	INT16	--	0 - 22
HistExpAlbRed	INT16	22	0 - 16,384
LoBndLocAlbNIR	FLOAT32	--	
HiBndLocAlbNIR	FLOAT32	--	
NBinsLocAlbNIR	INT16	--	0 - 22
HistLocAlbNIR	INT16	22	0 - 16,384
LoBndLocAlbNIRNoFill	FLOAT32	--	
HiBndLocAlbNIRNoFill	FLOAT32	--	
NBinsLocAlbNIRNoFill	INT16	--	0 - 22
HistLocAlbNIRNoFill	INT16	22	0 - 16,384
LoBndLocAlbClearNIR	FLOAT32	--	
HiBndLocAlbClearNIR	FLOAT32	--	
NBinsLocAlbClearNIR	INT16	--	0 - 22
HistLocAlbClearNIR	INT16	22	0 - 16,384
LoBndLocAlbClearNIRNoFill	FLOAT32	--	
HiBndLocAlbClearNIRNoFill	FLOAT32	--	
NBinsLocAlbClearNIRNoFill	INT16	--	0 - 22
HistLocAlbClearNIRNoFill	INT16	22	0 - 16,384
LoBndLocAlbCloudNIR	FLOAT32	--	



Data Field Name	Data Type	Field Dimensions	Valid Range
HiBndLocAlbCloudNIR	FLOAT32	--	
NBinsLocAlbCloudNIR	INT16	--	0 - 22
HistLocAlbCloudNIR	INT16	22	0 - 16,384
LoBndLocAlbCloudNIRNoFill	FLOAT32	--	
HiBndLocAlbCloudNIRNoFill	FLOAT32	--	
NBinsLocAlbCloudNIRNoFill	INT16	--	0 - 22
HistLocAlbCloudNIRNoFill	INT16	22	0 - 16,384
LoBndResAlbNIR	FLOAT32	--	
HiBndResAlbNIR	FLOAT32	--	
NBinsResAlbNIR	INT16	--	0 - 22
HistResAlbNIR	INT16	22	0 - 16,384
LoBndResAlbNIRNoFill	FLOAT32	--	
HiBndResAlbNIRNoFill	FLOAT32	--	
NBinsResAlbNIRNoFill	INT16	--	0 - 22
HistResAlbNIRNoFill	INT16	22	0 - 16,384
LoBndExpAlbNIR	FLOAT32	--	
HiBndExpAlbNIR	FLOAT32	--	
NBinsExpAlbNIR	INT16	--	0 - 22
HistExpAlbNIR	INT16	22	0 - 16,384
<i>BlockQaGlobalHist2: Block-level Histograms</i>			
LoBndResAlbTopBlue	FLOAT32	--	
HiBndResAlbTopBlue	FLOAT32	--	
NBinsResAlbTopBlue	INT16	--	0 - 22
HistResAlbTopBlue	INT16	22	0 - 16,384
LoBndResAlbSideBlueDf	FLOAT32	--	
HiBndResAlbSideBlueDf	FLOAT32	--	
NBinsResAlbSideBlueDf	INT16	--	0 - 22
HistResAlbSideBlueDf	INT16	22	0 - 16,384
LoBndResAlbSideBlueCf	FLOAT32	--	
HiBndResAlbSideBlueCf	FLOAT32	--	
NBinsResAlbSideBlueCf	INT16	--	0 - 22



Data Field Name	Data Type	Field Dimensions	Valid Range
HistResAlbSideBlueCf	INT16	22	0 - 16,384
LoBndResAlbSideBlueBf	FLOAT32	--	
HiBndResAlbSideBlueBf	FLOAT32	--	
NBinsResAlbSideBlueBf	INT16	--	0 - 22
HistResAlbSideBlueBf	INT16	22	0 - 16,384
LoBndResAlbSideBlueAf	FLOAT32	--	
HiBndResAlbSideBlueAf	FLOAT32	--	
NBinsResAlbSideBlueAf	INT16	--	0 - 22
HistResAlbSideBlueAf	INT16	22	0 - 16,384
LoBndResAlbSideBlueAn	FLOAT32	--	
HiBndResAlbSideBlueAn	FLOAT32	--	
NBinsResAlbSideBlueAn	INT16	--	0 - 22
HistResAlbSideBlueAn	INT16	22	0 - 16,384
LoBndResAlbSideBlueAa	FLOAT32	--	
HiBndResAlbSideBlueAa	FLOAT32	--	
NBinsResAlbSideBlueAa	INT16	--	0 - 22
HistResAlbSideBlueAa	INT16	22	0 - 16,384
LoBndResAlbSideBlueBa	FLOAT32	--	
HiBndResAlbSideBlueBa	FLOAT32	--	
NBinsResAlbSideBlueBa	INT16	--	0 - 22
HistResAlbSideBlueBa	INT16	22	0 - 16,384
LoBndResAlbSideBlueCa	FLOAT32	--	
HiBndResAlbSideBlueCa	FLOAT32	--	
NBinsResAlbSideBlueCa	INT16	--	0 - 22
HistResAlbSideBlueCa	INT16	22	0 - 16,384
LoBndResAlbSideBlueDa	FLOAT32	--	
HiBndResAlbSideBlueDa	FLOAT32	--	
NBinsResAlbSideBlueDa	INT16	--	0 - 22
HistResAlbSideBlueDa	INT16	22	0 - 16,384
LoBndResAlbTopGreen	FLOAT32	--	
HiBndResAlbTopGreen	FLOAT32	--	

Data Field Name	Data Type	Field Dimensions	Valid Range
NBinsResAlbTopGreen	INT16	--	0 - 22
HistResAlbTopGreen	INT16	22	0 - 16,384
LoBndResAlbSideGreenDf	FLOAT32	--	
HiBndResAlbSideGreenDf	FLOAT32	--	
NBinsResAlbSideGreenDf	INT16	--	0 - 22
HistResAlbSideGreenDf	INT16	22	0 - 16,384
LoBndResAlbSideGreenCf	FLOAT32	--	
HiBndResAlbSideGreenCf	FLOAT32	--	
NBinsResAlbSideGreenCf	INT16	--	0 - 22
HistResAlbSideGreenCf	INT16	22	0 - 16,384
LoBndResAlbSideGreenBf	FLOAT32	--	
HiBndResAlbSideGreenBf	FLOAT32	--	
NBinsResAlbSideGreenBf	INT16	--	0 - 22
HistResAlbSideGreenBf	INT16	22	0 - 16,384
LoBndResAlbSideGreenAf	FLOAT32	--	
HiBndResAlbSideGreenAf	FLOAT32	--	
NBinsResAlbSideGreenAf	INT16	--	0 - 22
HistResAlbSideGreenAf	INT16	22	0 - 16,384
LoBndResAlbSideGreenAn	FLOAT32	--	
HiBndResAlbSideGreenAn	FLOAT32	--	
NBinsResAlbSideGreenAn	INT16	--	0 - 22
HistResAlbSideGreenAn	INT16	22	0 - 16,384
LoBndResAlbSideGreenAa	FLOAT32	--	
HiBndResAlbSideGreenAa	FLOAT32	--	
NBinsResAlbSideGreenAa	INT16	--	0 - 22
HistResAlbSideGreenAa	INT16	22	0 - 16,384
LoBndResAlbSideGreenBa	FLOAT32	--	
HiBndResAlbSideGreenBa	FLOAT32	--	
NBinsResAlbSideGreenBa	INT16	--	0 - 22
HistResAlbSideGreenBa	INT16	22	0 - 16,384
LoBndResAlbSideGreenCa	FLOAT32	--	



Data Field Name	Data Type	Field Dimensions	Valid Range
HiBndResAlbSideGreenCa	FLOAT32	--	
NBinsResAlbSideGreenCa	INT16	--	0 - 22
HistResAlbSideGreenCa	INT16	22	0 - 16,384
LoBndResAlbSideGreenDa	FLOAT32	--	
HiBndResAlbSideGreenDa	FLOAT32	--	
NBinsResAlbSideGreenDa	INT16	--	0 - 22
HistResAlbSideGreenDa	INT16	22	0 - 16,384
LoBndResAlbTopRed	FLOAT32	--	
HiBndResAlbTopRed	FLOAT32	--	
NBinsResAlbTopRed	INT16	--	0 - 22
HistResAlbTopRed	INT16	22	0 - 16,384
LoBndResAlbSideRedDf	FLOAT32	--	
HiBndResAlbSideRedDf	FLOAT32	--	
NBinsResAlbSideRedDf	INT16	--	0 - 22
HistResAlbSideRedDf	INT16	22	0 - 16,384
LoBndResAlbSideRedCf	FLOAT32	--	
HiBndResAlbSideRedCf	FLOAT32	--	
NBinsResAlbSideRedCf	INT16	--	0 - 22
HistResAlbSideRedCf	INT16	22	0 - 16,384
LoBndResAlbSideRedBf	FLOAT32	--	
HiBndResAlbSideRedBf	FLOAT32	--	
NBinsResAlbSideRedBf	INT16	--	0 - 22
HistResAlbSideRedBf	INT16	22	0 - 16,384
LoBndResAlbSideRedAf	FLOAT32	--	
HiBndResAlbSideRedAf	FLOAT32	--	
NBinsResAlbSideRedAf	INT16	--	0 - 22
HistResAlbSideRedAf	INT16	22	0 - 16,384
LoBndResAlbSideRedAn	FLOAT32	--	
HiBndResAlbSideRedAn	FLOAT32	--	
NBinsResAlbSideRedAn	INT16	--	0 - 22
HistResAlbSideRedAn	INT16	22	0 - 16,384

Data Field Name	Data Type	Field Dimensions	Valid Range
LoBndResAlbSideRedAa	FLOAT32	--	
HiBndResAlbSideRedAa	FLOAT32	--	
NBinsResAlbSideRedAa	INT16	--	0 - 22
HistResAlbSideRedAa	INT16	22	0 - 16,384
LoBndResAlbSideRedBa	FLOAT32	--	
HiBndResAlbSideRedBa	FLOAT32	--	
NBinsResAlbSideRedBa	INT16	--	0 - 22
HistResAlbSideRedBa	INT16	22	0 - 16,384
LoBndResAlbSideRedCa	FLOAT32	--	
HiBndResAlbSideRedCa	FLOAT32	--	
NBinsResAlbSideRedCa	INT16	--	0 - 22
HistResAlbSideRedCa	INT16	22	0 - 16,384
LoBndResAlbSideRedDa	FLOAT32	--	
HiBndResAlbSideRedDa	FLOAT32	--	
NBinsResAlbSideRedDa	INT16	--	0 - 22
HistResAlbSideRedDa	INT16	22	0 - 16,384
LoBndResAlbTopNIR	FLOAT32	--	
HiBndResAlbTopNIR	FLOAT32	--	
NBinsResAlbTopNIR	INT16	--	0 - 22
HistResAlbTopNIR	INT16	22	0 - 16,384
LoBndResAlbSideNIRdf	FLOAT32	--	
HiBndResAlbSideNIRdf	FLOAT32	--	
NBinsResAlbSideNIRdf	INT16	--	0 - 22
HistResAlbSideNIRdf	INT16	22	0 - 16,384
LoBndResAlbSideNIRcf	FLOAT32	--	
HiBndResAlbSideNIRcf	FLOAT32	--	
NBinsResAlbSideNIRcf	INT16	--	0 - 22
HistResAlbSideNIRcf	INT16	22	0 - 16,384
LoBndResAlbSideNIRbf	FLOAT32	--	
HiBndResAlbSideNIRbf	FLOAT32	--	
NBinsResAlbSideNIRbf	INT16	--	0 - 22



Data Field Name	Data Type	Field Dimensions	Valid Range
HistResAlbSideNIRBf	INT16	22	0 - 16,384
LoBndResAlbSideNIRAf	FLOAT32	--	
HiBndResAlbSideNIRAf	FLOAT32	--	
NBinsResAlbSideNIRAf	INT16	--	0 - 22
HistResAlbSideNIRAf	INT16	22	0 - 16,384
LoBndResAlbSideNIRAn	FLOAT32	--	
HiBndResAlbSideNIRAn	FLOAT32	--	
NBinsResAlbSideNIRAn	INT16	--	0 - 22
HistResAlbSideNIRAn	INT16	22	0 - 16,384
LoBndResAlbSideNIRAA	FLOAT32	--	
HiBndResAlbSideNIRAA	FLOAT32	--	
NBinsResAlbSideNIRAA	INT16	--	0 - 22
HistResAlbSideNIRAA	INT16	22	0 - 16,384
LoBndResAlbSideNIRBa	FLOAT32	--	
HiBndResAlbSideNIRBa	FLOAT32	--	
NBinsResAlbSideNIRBa	INT16	--	0 - 22
HistResAlbSideNIRBa	INT16	22	0 - 16,384
LoBndResAlbSideNIRCa	FLOAT32	--	
HiBndResAlbSideNIRCa	FLOAT32	--	
NBinsResAlbSideNIRCa	INT16	--	0 - 22
HistResAlbSideNIRCa	INT16	22	0 - 16,384
LoBndResAlbSideNIRDa	FLOAT32	--	
HiBndResAlbSideNIRDa	FLOAT32	--	
NBinsResAlbSideNIRDa	INT16	--	0 - 22
HistResAlbSideNIRDa	INT16	22	0 - 16,384
LoBndResAlbSideCamsBlue	FLOAT32	--	
HiBndResAlbSideCamsBlue	FLOAT32	--	
NBinsResAlbSideCamsBlue	INT16	--	0 - 22
HistResAlbSideCamsBlue	INT16	22	0 - 16,384
LoBndResAlbSideCamsGreen	FLOAT32	--	
HiBndResAlbSideCamsGreen	FLOAT32	--	

Data Field Name	Data Type	Field Dimensions	Valid Range
NBinsResAlbSideCamsGreen	INT16	--	0 - 22
HistResAlbSideCamsGreen	INT16	22	0 - 16,384
LoBndResAlbSideCamsRed	FLOAT32	--	
HiBndResAlbSideCamsRed	FLOAT32	--	
NBinsResAlbSideCamsRed	INT16	--	0 - 22
HistResAlbSideCamsRed	INT16	22	0 - 16,384
LoBndResAlbSideCamsNIR	FLOAT32	--	
HiBndResAlbSideCamsNIR	FLOAT32	--	
NBinsResAlbSideCamsNIR	INT16	--	0 - 22
HistResAlbSideCamsNIR	INT16	22	0 - 16,384
BlockQaGlobalHist3: Block-level Histograms			
LoBndRlraKm	FLOAT32	--	
HiBndRlraKm	FLOAT32	--	
NbinsRlraKm	INT16	--	0 - 22
HistRlraKm	INT16	22	0 - 16,384
LoBndRlraKmNoFill	FLOAT32	--	
HiBndRlraKmNoFill	FLOAT32	--	
NbinsRlraKmNoFill	INT16	--	0 - 22
HistRlraKmNoFill	INT16	22	0 - 16,384
LoBndLiqCloudPhaseProb	FLOAT32	--	
HiBndLiqCloudPhaseProb	FLOAT32	--	
NBinsLiqCloudPhaseProb	INT16	--	0 - 22
HistLiqCloudPhaseProb	INT16	22	0 - 16,384
LoBndSunZenithIndex	FLOAT32	--	
HiBndSunZenithIndex	FLOAT32	--	
NBinsSunZenithIndex	INT16	--	0 - 22
HistSunZenithIndex	INT16	22	0 - 16,384
LoBndRelAzimuthAngleDf	FLOAT32	--	
HiBndRelAzimuthAngleDf	FLOAT32	--	
NBinsRelAzimuthAngleDf	INT16	--	0 - 22
HistRelAzimuthAngleDf	INT16	22	0 - 16,384



Data Field Name	Data Type	Field Dimensions	Valid Range
LoBndRelAzimuthAngleCf	FLOAT32	--	
HiBndRelAzimuthAngleCf	FLOAT32	--	
NBinsRelAzimuthAngleCf	INT16	--	0 - 22
HistRelAzimuthAngleCf	INT16	22	0 - 16,384
LoBndRelAzimuthAngleBf	FLOAT32	--	
HiBndRelAzimuthAngleBf	FLOAT32	--	
NBinsRelAzimuthAngleBf	INT16	--	0 - 22
HistRelAzimuthAngleBf	INT16	22	0 - 16,384
LoBndRelAzimuthAngleAf	FLOAT32	--	
HiBndRelAzimuthAngleAf	FLOAT32	--	
NBinsRelAzimuthAngleAf	INT16	--	0 - 22
HistRelAzimuthAngleAf	INT16	22	0 - 16,384
LoBndRelAzimuthAngleAn	FLOAT32	--	
HiBndRelAzimuthAngleAn	FLOAT32	--	
NBinsRelAzimuthAngleAn	INT16	--	0 - 22
HistRelAzimuthAngleAn	INT16	22	0 - 16,384
LoBndRelAzimuthAngleAa	FLOAT32	--	
HiBndRelAzimuthAngleAa	FLOAT32	--	
NBinsRelAzimuthAngleAa	INT16	--	0 - 22
HistRelAzimuthAngleAa	INT16	22	0 - 16,384
LoBndRelAzimuthAngleBa	FLOAT32	--	
HiBndRelAzimuthAngleBa	FLOAT32	--	
NBinsRelAzimuthAngleBa	INT16	--	0 - 22
HistRelAzimuthAngleBa	INT16	22	0 - 16,384
LoBndRelAzimuthAngleCa	FLOAT32	--	
HiBndRelAzimuthAngleCa	FLOAT32	--	
NBinsRelAzimuthAngleCa	INT16	--	0 - 22
HistRelAzimuthAngleCa	INT16	22	0 - 16,384
LoBndRelAzimuthAngleDa	FLOAT32	--	
HiBndRelAzimuthAngleDa	FLOAT32	--	
NBinsRelAzimuthAngleDa	INT16	--	0 - 22

Data Field Name	Data Type	Field Dimensions	Valid Range
HistRelAzimuthAngleDa	INT16	22	0 - 16,384
LoBndBrightnessIndexDf	FLOAT32	--	
HiBndBrightnessIndexDf	FLOAT32	--	
NBinsBrightnessIndexDf	INT16	--	0 - 22
HistBrightnessIndexDf	INT16	22	0 - 16,384
LoBndBrightnessIndexCf	FLOAT32	--	
HiBndBrightnessIndexCf	FLOAT32	--	
NBinsBrightnessIndexCf	INT16	--	0 - 22
HistBrightnessIndexCf	INT16	22	0 - 16,384
LoBndBrightnessIndexBf	FLOAT32	--	
HiBndBrightnessIndexBf	FLOAT32	--	
NBinsBrightnessIndexBf	INT16	--	0 - 22
HistBrightnessIndexBf	INT16	22	0 - 16,384
LoBndBrightnessIndexAf	FLOAT32	--	
HiBndBrightnessIndexAf	FLOAT32	--	
NBinsBrightnessIndexAf	INT16	--	0 - 22
HistBrightnessIndexAf	INT16	22	0 - 16,384
LoBndBrightnessIndexAn	FLOAT32	--	
HiBndBrightnessIndexAn	FLOAT32	--	
NBinsBrightnessIndexAn	INT16	--	0 - 22
HistBrightnessIndexAn	INT16	22	0 - 16,384
LoBndBrightnessIndexAa	FLOAT32	--	
HiBndBrightnessIndexAa	FLOAT32	--	
NBinsBrightnessIndexAa	INT16	--	0 - 22
HistBrightnessIndexAa	INT16	22	0 - 16,384
LoBndBrightnessIndexBa	FLOAT32	--	
HiBndBrightnessIndexBa	FLOAT32	--	
NBinsBrightnessIndexBa	INT16	--	0 - 22
HistBrightnessIndexBa	INT16	22	0 - 16,384
LoBndBrightnessIndexCa	FLOAT32	--	
HiBndBrightnessIndexCa	FLOAT32	--	



Data Field Name	Data Type	Field Dimensions	Valid Range
NBinsBrightnessIndexCa	INT16	--	0 - 22
HistBrightnessIndexCa	INT16	22	0 - 16,384
LoBndBrightnessIndexDa	FLOAT32	--	
HiBndBrightnessIndexDa	FLOAT32	--	
NBinsBrightnessIndexDa	INT16	--	0 - 22
HistBrightnessIndexDa	INT16	22	0 - 16,384
LoBndClearSkyCamsBlue	FLOAT32	--	
HiBndClearSkyCamsBlue	FLOAT32	--	
NBinsClearSkyCamsBlue	INT16	--	0 - 22
HistClearSkyCamsBlue	INT16	22	0 - 16,384
LoBndClearSkyCamsGreen	FLOAT32	--	
HiBndClearSkyCamsGreen	FLOAT32	--	
NBinsClearSkyCamsGreen	INT16	--	0 - 22
HistClearSkyCamsGreen	INT16	22	0 - 16,384
LoBndClearSkyCamsRed	FLOAT32	--	
HiBndClearSkyCamsRed	FLOAT32	--	
NBinsClearSkyCamsRed	INT16	--	0 - 22
HistClearSkyCamsRed	INT16	22	0 - 16,384
LoBndClearSkyCamsNIR	FLOAT32	--	
HiBndClearSkyCamsNIR	FLOAT32	--	
NBinsClearSkyCamsNIR	INT16	--	0 - 22
HistClearSkyCamsNIR	INT16	22	0 - 16,384

8.0 MISR LEVEL 2 AEROSOL/SURFACE PRODUCT

8.1 MISR LEVEL 2 A/S PRODUCT GRANULE NAMES

MISR Level 2 Aerosol/Surface Products are composed of the three granules listed below (Table 8-1).

Table 8-1: MISR Level 2 Aerosol/Surface File Granule Names.

MISR LEVEL 2 A/S FILE GRANULE NAME	ESDT Name	Section
MISR_AM1_AS_AEROSOL_Pnnn_Onnnnnn_Fnn_nnnn.hdf	MIL2ASAE	8.4
MISR_AM1_AS_LAND_Pnnn_Onnnnnn_Fnn_nnnn.hdf	MIL2ASLS	8.5
MISR_AM1_AS_OCEAN_Pnnn_Onnnnnn_Fnn_nnnn.hdf	MIL2ASOS	8.6

8.2 MISR LEVEL 2 A/S PRODUCT GRANULE BRIEF DESCRIPTIONS

The Aerosol/Surface Subsystem Software provides for the end-to-end generation of the MISR Level 2 Aerosol/Surface Product. The product generation occurs in several stages.

Initially, the Level 1B2 high-resolution data samples are averaged to the resolutions required by the Aerosol and Surface retrieval algorithms. The averaged radiances are then normalized to an Earth-Sun distance of 1 AU, converted to equivalent reflectances, corrected for out-of-band radiance, and corrected for ozone absorption. The 1.1 km x 1.1 km subregions are then screened for contamination from sources such as clouds, cloud shadows, sun glitter over water, topographically complex terrain, and topographically shadowed regions.

Next, these corrected equivalent reflectances from selected subregions contained within the 17.6 x 17.6 km region are compared to model equivalent reflectances obtained from the SMART (Simulated MISR Ancillary Radiative Transfer) dataset to obtain the best estimate of the atmospheric aerosol properties. The model equivalent reflectances correspond to various aerosol types and amounts, sun and view geometries, surface types and meteorological conditions. A subset of appropriate SMART models is chosen based upon ambient meteorological conditions, sun and view angles, and surface type. Constraints on optical depth are also computed from the minimum corrected equivalent reflectances within a region. Over dark water regions, a set of 4 χ^2 minimization tests are performed, comparing model equivalent reflectances, calculated assuming an ocean surface boundary, and the MISR regional equivalent reflectances. The aerosol models which result in the lowest residuals indicate the column aerosol parameters that best characterize the region. Over heterogeneous land regions, the minimization is performed in a slightly different manner, due to the variability of the surface reflectance. First, view angle-dependent empirical orthogonal functions (EOFs), computed from the corrected MISR subregional equivalent reflectances, are used in an expansion of the surface-reflected component of the equivalent reflectances at the top of the atmosphere. This expansion term plus the model atmospheric path equivalent reflectances (i.e., TOA

equivalent reflectances for a black surface) are then compared to the MISR regional TOA equivalent reflectances. The model which results in the lowest residuals (based on a least squares determination of the EOF coefficients in the expansion term) indicates the column aerosol parameters that best characterize the region. When the surface (ocean or land) is not directly observable because of an optically thick atmospheric condition due to an unusually large amount of atmospheric contamination (e.g. dust or volcanic plumes), then the model atmospheric path equivalent reflectances are compared directly to the MISR regional equivalent reflectances, using the 4 χ^2 minimization tests.

A subregional surface retrieval is conducted on regions for which valid land aerosol retrievals exist. The retrieval is performed using the corrected equivalent reflectances, retrieved aerosol parameters, and auxiliary information from the SMART dataset. The spectral and PAR-integrated bihemispherical reflectance (BHR) and directional hemispherical reflectance (DHR) are retrieved, along with the spectral hemispherical-directional reflectance factors (HDRF) and bidirectional reflectance factors (BRF) and BRF model parameters, for all valid land and inland water subregions. Subregional surface classification and leaf area index (LAI) and subregional FPAR (fraction of photosynthetically-active radiation) are also determined. Subregional variability is also calculated for land regions. For tropical ocean regions near the equator with valid aerosol retrievals, the water-leaving equivalent reflectance at the B-camera viewing angle is also retrieved, after correcting the MISR equivalent reflectances for sun glitter and whitecaps. Two different methods of atmospheric correction are used, and both results are used to determine a corresponding phytoplankton pigment concentration.

Table 8-2: Surface-Atmosphere Radiation Interaction Terms

Term	Name	Definition	Units
BRDF	Bidirectional Reflectance Distribution Function	surface-leaving radiance divided by incident irradiance from a single direction	ster ⁻¹
BRF	Bidirectional Reflectance Factor	surface-leaving radiance divided by radiance from a Lambert reflector illuminated from a single direction	n/a
HDRF	Hemispherical-Directional Reflectance Factor	surface-leaving radiance divided by radiance from a Lambert reflector with same illumination	n/a
DHR	Directional-Hemispherical Reflectance	radiant exitance divided by irradiance under illumination from a single direction	n/a
BHR	Bi-Hemispherical Reflectance	radiant exitance divided by irradiance under same illumination conditions	n/a
L	Radiance	radiant energy per time-area-solid angle	W/m ² -ster
E	Irradiance	radiant energy flux	W/m ²
M	Radiant Exitance	radiant energy flux leaving a surface	W/m ²

8.3 MISR LEVEL 2 A/S PRODUCT GRANULE DATA SETS

The product will be produced as 3 separate ESDTs. The Aerosol, Land Surface, and Ocean Surface files each are stored as one physical file, as shown in Table 8-3. Each physical file is in the HDF-EOS Grid “stacked-block” format and each contains two or three HDF-EOS Grid datasets, corresponding to parameters at 1.1 km spatial resolution, at 17.6 km spatial resolution, and at 70.4 km spatial resolution. The grid datasets will have the usual x and y dimensions, as well as a third dimension corresponding to the SOM block number. The x and y dimensions will correspond to the the number of 1.1 km² subregions, 17.6 km² regions, or 70.4 km² domains in the along-track and cross-track directions. For the files containing aerosol parameters and land surface parameters, the number of blocks in the grid dataset will correspond exactly to the number and location of blocks in the Level 1B2 and Level 2 TOA/Cloud Product files for the same orbit. Also, the blocks that make up the Aerosol/Surface Product files are a direct subset of the blocks that make up the Ancillary Geographic Product. For the ocean surface parameters, there will only be 6 blocks present, because the parameters are only reported along a 600 km belt around the equator.

Table 8-3: Level 2 Aerosol/Surface Product Files and Grid Datasets.

ESDT Shortname	Local Granule ID^a	Grid Dataset Name
MIL2ASAE	MISR_AM1_AS_AEROSOL_Pnnn_Onnnnnn_Fnn_nnnn.hdf	SubregParamsAer
		RegParamsAer
		DomParamsAer
MIL2ASLS	MISR_AM1_AS_LAND_Pnnn_Onnnnnn_Fnn_nnnn.hdf	SubregParamsLnd
		RegParamsLnd
MIL2ASOS	MISR_AM1_AS_OCEAN_Pnnn_Onnnnnn_Fnn_nnnn.hdf	SubregParamsOcn
		RegParamsOcn

a. *Pnnn* corresponds to the orbit path, *Onnnnnn* corresponds to the absolute orbit number, *Fnn* is the file format version number, and *nnnn* is the file content version number.

8.4 MISR LEVEL 2 MIL2ASAE AEROSOL PRODUCT

8.4.1 File Metadata Description

Table 8-4: File Metadata for Aerosol Product Files.

File Metadata Field Name	Definition	Data Type	Units	Valid Range
Path_number	Orbit path number	INT32	N/A	1-233
AGP_version_id	Version identifier for AGP	INT32	N/A	2
DID_version_id	Version identifier for DID (DTED [Digital Terrain Elevation Dataset] Intermediate Dataset)	INT32	N/A	4
Number_blocks	Total number of blocks	INT32	N/A	1-180
Ocean_blocks_size	Ocean_blocks.number dimension	INT32	N/A	1-180
Ocean_blocks.count	Total number of blocks containing entirely ocean radiances	INT32	N/A	1-180
Ocean_blocks.numbers	List of block numbers containing entirely ocean radiances	INT32	N/A	1-180
SOM_parameters.som_ellipsoid.a	Semimajor axis of ellipsoid (m)	FLOAT64	meters	WGS84 ellipsoid (6.3781370E+06)
SOM_parameters.som_ellipsoid.e2	Eccentricity of ellipsoid squared	FLOAT64	N/A	WGS84 ellipsoid (6.6943480E-03)
SOM_parameters.som_orbit.aprime	Semimajor axis of orbit	FLOAT64	meters	Not used.
SOM_parameters.som_orbit.eprime	Eccentricity of orbit	FLOAT64	N/A	Not used.
SOM_parameters.som_orbit.gama	Longitude of perigee	FLOAT64	radians	Not used.
SOM_parameters.som_orbit.nrev	Number of revolutions per ground track repeat cycle	INT32	N/A	233
SOM_parameters.som_orbit.ro	Radius of circular orbit (m)	FLOAT64	meters	7.0780408E+06

File Metadata Field Name	Definition	Data Type	Units	Valid Range
SOM_parameters.som_orbit.i	Inclination of orbit (radians)	FLOAT64	radians	1.7157253
SOM_parameters.som_orbit.P2P1	Ratio of time of revolution over length of Earth rotation/orbit	FLOAT64	N/A	6.8666667E-02
SOM_parameters.som_orbit.lambda0	Geodetic longitude of ascending node at time 0 (radians)	FLOAT64	radians	-2pi to 2pi
Origin_block.ulc.x	SOM X coordinate (in meters) of the upper left corner of the first block	FLOAT64	meters	6 million to 33 million
Origin_block.ulc.y	SOM Y coordinate (in meters) of the upper left corner of the first block	FLOAT64	meters	+/- 12 million
Origin_block.lrc.x	SOM X coordinate (in meters) of the lower right corner of the first block	FLOAT64	meters	6 million to 33 million
Origin_block.lrc.y	SOM Y coordinate (in meters) of the lower right corner of the first block	FLOAT64	meters	+/- 12 million
Start_block	The block number in the AGP which corresponds to the first block in this file containing data.	INT32	N/A	1 - 180 Start_block < End block
End_block	The block number in the AGP which corresponds to the last block in this file containing data.	INT32	N/A	1 - 180 Start_block < End block
Cam_mode	Indicates whether the data in this grid file was obtained in MISR global mode or local mode.	INT32	N/A	0-1 1 = global 0 = local
Num_local_modes	The number of MISR local mode acquisitions contained in this file.	INT32	N/A	0-6 0 if data is global mode
Local_mode_site_name	The geographical name of the first local mode site contained in this file.	CHAR8	N/A	string up to 12 characters in length, including null
Orbit_QA	Indication of the overall quality of the orbit data based on analysis of quality flags in the spacecraft attitude and ephemeris data. Geolocation accuracy may be impaired for orbits with poor quality orbit data.	FLOAT32	N/A	-9999.0 = NoRetrieval, -1.0 = Poor, 0.0 = Nominal

8.4.2 Vdata Description

HDF vdatas are used in the aerosol product as “flag legends,” which map flag values to their defini-

tions. Flag legend vdatas consist of two fields called "Value" and "Description." The "Value" field is of type UINT8, and consists of one element. The "Description" field is of type CHAR8, and consists of 80 elements. There is one record per flag value. The flag legends are summarized below. To obtain the actual values of the flag values and descriptions, read the vdatas in the file, or refer to Table 8-9 in this document.

Table 8-5: Aerosol Product File Vdata Summary

Vdata Name	Records	Description
RetrAppMask Flag Legend	One per flag value	Map flag values to descriptions
OptDepthUpBdCam Flag Legend	One per flag value	Map flag values to descriptions
OptDepthUpBdBand Flag Legend	One per flag value	Map flag values to descriptions
AlgTypeFlag Flag Legend	One per flag value	Map flag values to descriptions
RegClassInd Flag Legend	One per flag value	Map flag values to descriptions
CamRainbow Flag Legend	One per flag value	Map flag values to descriptions
AerRetrSuccFlag Flag Legend	One per flag value	Map flag values to descriptions
ColOzAbundSrc Flag Legend	One per flag value	Map flag values to descriptions
SfcWindspSrc Flag Legend	One per flag value	Map flag values to descriptions
SfcPresSrc Flag Legend	One per flag value	Map flag values to descriptions
RegAltPresSrc Flag Legend	One per flag value	Map flag values to descriptions
SfcAirTempSrc Flag Legend	One per flag value	Map flag values to descriptions
RegAltAirTempSrc Flag Legend	One per flag value	Map flag values to descriptions
ColPrecipWaterSrc Flag Legend	One per flag value	Map flag values to descriptions
RelHumidProfileSrc Flag Legend	One per flag value	Map flag values to descriptions
StratAerFlag Flag Legend	One per flag value	Map flag values to descriptions
StratAerOptDepthSrc Flag Legend	One per flag value	Map flag values to descriptions
CirrFlag Flag Legend	One per flag value	Map flag values to descriptions
CirrOptDepthSrc Flag Legend	One per flag value	Map flag values to descriptions

8.4.3 Per-grid Metadata Description

Table 8-6: Per-grid Metadata for Aerosol Product Files.

Common Grid Metadata	Definition	Data Type	Valid Values
Block_size.resolution_x	Resolution of block x dimension in meters	INT32	1100, 17600, 70400
Block_size.resolution_y	Resolution of block y dimension in meters	INT32	1100, 17600, 70400
Block_size.size_x	Block x dimension	INT32	128, 8, 2
Block_size.size_y	Block y dimension	INT32	512, 32, 8

Aerosol Grid Metadata	Definition	Data Type	Valid Values
<i>Aerosol SubregParams (1.1 km x 1.1 km)</i>			

8.4.4 Per-block Metadata Description

Table 8-7: Per-block Metadata for Aerosol Product Files.

PerBlockMetadataCommon	Definition	Data Type	Valid Values
Block_number	Current block number	INT32	1-180
Ocean_flag	Flag signalling whether the block contains entirely ocean radiances	INT8	0 = block has no ocean or is a mix of ocean and land 1 = block is entirely ocean
Block_coor_ulc_som_meter.x	Upper left corner SOM block x coordinate in meters	FLOAT64	
Block_coor_ulc_som_meter.y	Upper left corner SOM block y coordinate in meters	FLOAT64	
Block_coor_lrc_som_meter.x	Lower right corner SOM block x coordinate in meters	FLOAT64	
Block_coor_lrc_som_meter.y	Lower right corner SOM block y coordinate in meters	FLOAT64	

PerBlockMetadataCommon	Definition	Data Type	Valid Values
Data_flag	Flag signalling whether the block contains entirely fill data	INT8	0 = block contains entirely fill data 1 = block contains valid data

Common Per Block Metadata	Definition	Data Type	Valid Values
Geometric DQI	Geometric Data Quality Indicator copied from the L1B2 Terrain-projected parameter file.	FLOAT64	-1 to 1

8.4.5 Per-line Metadata Description

None.

8.4.6 Per-pixel Metadata Description

None.

8.4.7 Grid Data Set Descriptions

In order to minimize storage for the Aerosol/Surface Product, some parameters will be packed so that each bit represents a logical value, or some number of bits within a byte or word represent a flag value. To facilitate the interpretation of scientific data, floating point values are not scaled. Floating point values and integer values may take on a flag value indicating invalid data. Currently, there is a flag value of -9999.0, representing missing floating point data; a flag value of 253, representing missing data for unsigned 8-bit integers; a flag value of 65533, representing missing data for unsigned 16-bit integers; and a flag value of -32768, representing missing data for 16-bit signed integers. In addition, there are flag values representing underflow and overflow. There is a flag value of 254, representing underflow for unsigned 8-bit integers; a flag value of 255, representing overflow for unsigned 8-bit integers; a flag value of 65534, representing underflow for unsigned 16-bit integers; a flag value of 65535, representing overflow for unsigned 16-bit integers; a flag value of -32767, representing underflow for 16-bit signed integers; and a flag value of 32767, representing overflow for 16-bit signed integers. Note that we may later add more flag values to distinguish

other reasons that the data are missing (e.g. never computed, arithmetic error, etc.).

Table 8-8: Aerosol Product Field Dimension Descriptions.

Dimension	Description	Valid Values
SOMBlockDim	<i>SOMBlockDim</i> is the number of SOM blocks in the file. The slowest-varying dimension is implicitly the SOM block dimension. It is not shown in the tables below.	- for the Aerosol and Land Surface files this can vary, with a typical value being approximately 140 - for the Ocean Surface file this will be 6
XDim	<i>XDim</i> is the number of lines in a block. The x dimension direction is identical to the standard SOM x dimension.	128 for 1.1 km parameters or 8 for 17.6 km parameters or 2 for 70.4 km parameters
YDim	<i>YDim</i> is the number of samples in a block. The y dimension direction is identical to the standard SOM y dimension.	512 for 1.1 km parameters or 32 for 17.6 km parameters or 8 for 70.4 km parameters
NCamDim	<i>NCamDim</i> is the number of MISR cameras.	9 where 1 = D forward 2 = C forward 3 = B forward 4 = A forward 5 = A nadir 6 = A aftward 7 = B aftward 8 = C aftward 9 = D aftward
NBandDim	<i>NBandDim</i> is the number of bands in a MISR camera.	4 where 1 = Blue 2 = Green 3 = Red 4 = NIR
NAerMixtureDim ^a	<i>NAerMixtureDim</i> is the maximum number of successful aerosol mixtures to report.	1-100
NRelHumDim	<i>NRelHumDim</i> is the number of levels in the relative humidity profile.	36

a. The aerosol mixtures referred to by this dimension are those in the Mixture Product, described in Section 9.10 of this document, "MISR Ancillary MIANACP Mixture Product." The names and properties of all aerosol mixtures are contained in the Mixture Product. The Mixture Product is separate from the Aerosol Product, and must be ordered separately.

Table 8-9: Aerosol Product Grid Dataset Descriptions, part I

Field Name Parameter Description	Dimension ^a List	Number Type	Units	Transformation	Flag Values
Grid SubregParamsAer (Spatial Resolution: 1.1 km x 1.1 km, XDim = 128, YDim = 512)					
RetrAppMask Retrieval applicability mask	XDim, YDim, NBandDim, NCamDim	UINT8	n/a	n/a	0 = clear 1 = missing data 2 = poor quality 3 = glitter-con- taminated 4 = topo. obscured 5 = topo. shadowed 6 = topo. complex 7 = cloudy 8 = cloud shadow 9 = not smooth 10 = not correlated 11 = region not suitable 253 = fill
Grid RegParamsAer (Spatial Resolution: 17.6 km x 17.6 km, XDim = 8, YDim = 32)					
RegMeanSpectralOptDepth Regional mean spectral optical depth, computed from optical depths of successful aerosol mixtures	XDim, YDim, NBandDim	FLOAT32	n/a	n/a	-9999 = fill
RegMedianSpectralOptDepth Regional median spectral optical depth, computed from optical depths of successful aerosol mixtures	XDim, YDim, NBandDim	FLOAT32	n/a	n/a	-9999 = fill
RegStDevSpectralOptDepth Standard deviation of spectral optical depths of successful aerosol mixtures	XDim, YDim, NBandDim	FLOAT32	n/a	n/a	-9999 = fill
RegWgtMeanSpectralOptDepth Mean of spectral optical depths retrieved for all aerosol mixtures, each weighted by the inverse of the chi-square fitting parameter for that mixture (chi- square absolute for aerosol mixtures over dark water; chi- square heterogeneous for aerosol mixtures over land)	XDim, YDim, NBandDim	FLOAT32	n/a	n/a	-9999 = fill

Table 8-9: Aerosol Product Grid Dataset Descriptions, part I

Field Name Parameter Description	Dimension ^a List	Number Type	Units	Transformation	Flag Values
RegWgtStDevSpectralOptDepth Standard deviation of spectral optical depths retrieved for all aerosol mixtures, each weighted by the inverse of the chi-square fitting parameter for that mixture (chi-square absolute for aerosol mixtures over dark water; chi-square heterogeneous for aerosol mixtures over land)	XDim, YDim, NBandDim	FLOAT32	n/a	n/a	-9999 = fill
RegBestFitSpectralOptDepth Optical depth with smallest chi-square fitting parameter (chi-square absolute for aerosol mixtures over dark water; chi-square heterogeneous for aerosol mixtures over land), out of all aerosol mixtures	XDim, YDim, NBandDim	FLOAT32	n/a	n/a	-9999 = fill
RegMeanAngstromExponent Regional mean Angstrom exponent, computed from Angstrom exponents of successful aerosol mixtures	XDim, YDim	FLOAT32	n/a	n/a	-9999 = fill
RegStDevAngstromExponent Standard deviation of Angstrom exponents of successful aerosol mixtures	XDim, YDim	FLOAT32	n/a	n/a	-9999 = fill
RegBestFitAngstromExponent Angstrom exponent with smallest chi-square fitting parameter (chi-square absolute for aerosol mixtures over dark water; chi-square heterogeneous for aerosol mixtures over land), out of all aerosol mixtures	XDim, YDim	FLOAT32	n/a	n/a	-9999 = fill

Table 8-9: Aerosol Product Grid Dataset Descriptions, part I

Field Name Parameter Description	Dimension ^a List	Number Type	Units	Transformation	Flag Values
RegBestFitChisq Smallest value of chi-square fitting parameter (chi-square absolute for aerosol mixtures over dark water; chi-square heterogeneous for aerosol mixtures over land), out of all aerosol mixtures	XDim, YDim	FLOAT32	n/a	n/a	-9999 = fill
RegBestFitCombinedResidual Smallest value of combined residual fitting parameter (a function of retrieval chi-squares and optical depth uncertainty), out of all aerosol mixtures	XDim, YDim	FLOAT32	n/a	n/a	-9999 = fill
RegBestFitMixture Aerosol mixture with smallest chi-square fitting parameter (chi-square absolute for aerosol mixtures over dark water; chi-square heterogeneous for aerosol mixtures over land), out of all aerosol mixtures	XDim, YDim	UINT8	n/a	n/a	253 = fill
RegBestFitMixtureEqRefl Aerosol mixture equivalent reflectances corresponding to RegBestFitSpectralOptDepth	XDim, YDim, NBandDim, NCamDim	UINT8	n/a	n/a	253 = fill

Table 8-9: Aerosol Product Grid Dataset Descriptions, part I

Field Name Parameter Description	Dimension ^a List	Number Type	Units	Transformation	Flag Values
AlgTypeFlag Algorithm type flag	XDim, YDim	UINT8	n/a	n/a	0 = no retrieval 1 = dark water retrieval 2 = OTA (optically thick atmosphere) retrieval 3 = heterogeneous land retrieval 4 = no successful retrieval; optical depth from "low optical depth" default 5 = no successful retrieval; optical depth from "optical depth in previous region" default 6 = no successful retrieval; optical depth from "Rayleigh scattering only" default 7 = no successful retrieval; optical depth from "optical depth upper bound algorithm" default 253 = fill
RegClassInd Region classification indicator	XDim, YDim	UINT8	n/a	n/a	0 = clear region 1 = solar oblique region 2 = topo. complex region 3 = cloudy region 4 = no valid data in region 253 = fill

Table 8-9: Aerosol Product Grid Dataset Descriptions, part I

Field Name Parameter Description	Dimension ^a List	Number Type	Units	Transformation	Flag Values
AerRetrSuccFlag Aerosol retrieval success flag	XDim, YDim	UINT8	n/a	n/a	1 = no success matches with aerosol mixtures 2 = no potential matches 3 = aerosol retrieval algorithm failure 4 = aerosol retrieval not attempted 5 = insufficient data to perform aerosol retrieval 6 = inadequate scene contrast to perform aerosol retrieval 7 = successful aerosol retrieval 8 = unsuccessful aerosol retrieval over land; default optical depth value being reported 253 = fill
NumSuccAerMixture Number of successful mixtures (was previously NumSuccAerModel)	XDim, YDim	UINT8	n/a	n/a	253 = fill
NumCamUsed Number of cameras in each band which meet the minimum number of subregions constraint specified in the aerosol science configuration file. (was previously NumClearCam)	XDim, YDim, NBandDim	UINT8	n/a	n/a	253 = fill

Table 8-9: Aerosol Product Grid Dataset Descriptions, part I

Field Name Parameter Description	Dimension ^a List	Number Type	Units	Transformation	Flag Values
CamRainbowFlag Camera rainbow flag	XDim, YDim	UINT16	n/a	1 bit per camera stored. First bit is D_forward camera; ninth bit is D_aft camera. Remainder of bits are zero. D_for = (CamRainbowFlag & 1) ^b C_for = (CamRainbowFlag & 2) >> 1 B_for = (CamRainbowFlag & 4) >> 2 A_for = (CamRainbowFlag & 8) >> 3 A_nadir = (CamRainbowFlag & 16) >> 4 A_aft = (CamRainbowFlag & 32) >> 5 B_aft = (CamRainbowFlag & 64) >> 6 C_aft = (CamRainbowFlag & 128) >> 7 D_aft = (CamRainbowFlag & 256) >> 8	0 = rainbow-free (one-bit flag) 1 = rainbow-influenced (one-bit flag) 0 = fill (16-bit flag)
NumEofUsed Number of EOFs (empirical orthogonal functions) used in aerosol retrieval over heterogeneous surface	XDim, YDim, NBandDim	UINT8	n/a	n/a	253 = fill
NumAcceptHetOptDepth Number of acceptable optical depths retrieved over heterogeneous surface, which may be used in land surface retrievals	XDim, YDim, NAerMixtureDim	UINT8	n/a	n/a	253 = fill
HetContrast Heterogeneous surface contrast measure (was previous HetLandContrast)	XDim, YDim, NBandDim	FLOAT32	n/a	n/a	-9999 = fill
RegSfcRetrOptDepth Aerosol optical depth to be used in the land surface retrieval	XDim, YDim	FLOAT32	n/a	n/a	-9999 = fill

Table 8-9: Aerosol Product Grid Dataset Descriptions, part I

Field Name Parameter Description	Dimension ^a List	Number Type	Units	Transformation	Flag Values
RegSfcRetrOptDepthUnc Uncertainty in aerosol optical depth to be used in the land surface retrieval	XDim, YDim	FLOAT32	n/a	n/a	-9999 = fill
RegSfcRetrMixture Aerosol mixture to be used in the land surface retrieval	XDim, YDim	UINT8	n/a	n/a	253 = fill
RegSfcRetrAlgTypeFlag Algorithm type used to compute aerosol mixture and optical depth	XDim, YDim	UINT8	n/a	n/a	253 = fill
NumAcceptSubr Number of subregions of acceptable quality for retrieval	XDim, YDim, NBandDim, NCamDim	UINT16	n/a	n/a	65533 = fill
RegEqRefl Observed regional equivalent reflectances which were used in the aerosol retrieval	XDim, YDim, NBandDim, NCamDim	FLOAT32	n/a	n/a	-9999 = fill
RegEqReflStDev Standard deviation of observed regional equivalent reflectances which were used in the aerosol retrieval	XDim, YDim, NBandDim, NCamDim	FLOAT32	n/a	n/a	-9999 = fill
RegEqReflDarkest Darkest observed regional equivalent reflectances	XDim, YDim, NBandDim, NCamDim	FLOAT32	n/a	n/a	-9999 = fill

a. Fields dimensioned by `NAerMixtureDim` correspond to the aerosol mixtures described in Section 9.10 of this document. The aerosol mixture names and properties are contained in the Mixture Product, which must be ordered separately from the Aerosol Product.

b. '&' refers to the bitwise AND operator, and '>>' refers to the right shift operator

Table 8-9: Aerosol Product Grid Dataset Descriptions, part II

Field Name Parameter Description	Dimension List	Number Type	Units	Transformation	Flag Values
SolZenAng Solar zenith angle	XDim, YDim	FLOAT32	degrees	n/a	-9999 = fill
ViewZenAng View zenith angle (9 cameras)	XDim, YDim, NCamDim	FLOAT32	degrees	n/a	-9999 = fill

Field Name Parameter Description	Dimension List	Number Type	Units	Transformation	Flag Values
RelViewCamAziAng Relative view-Sun azimuth (9 cameras)	XDim, YDim, NCamDim	FLOAT32	degrees	n/a	-9999 = fill
ScatterAng Scattering angle (9 cameras)	XDim, YDim, NCamDim	FLOAT32	degrees	n/a	-9999 = fill
GlitterAng Glitter angle (9 cameras)	XDim, YDim, NCamDim	FLOAT32	degrees	n/a	-9999 = fill
AerRetrSuccFlagPerMixture Aerosol retrieval success flag per mixture (was previously AerCompModId)	XDim, YDim, NAerMixtureDim	UINT8	n/a	n/a	253 = fill; X ² s not computed 252 = X ² s computed, with no successful match 251 = X ² s computed, with no successful match; this flag value applies when a default mixture is used 1-100 = X ² s computed with a successful match; value is equal to mixture number identifier
OptDepthPerMixture Column optical depth at 555 nm (was previously ColOptDepth)	XDim, YDim, NAerMixtureDim	FLOAT32	n/a	n/a	-9999 = fill
OptDepthUncPerMixture Column optical depth uncertainty at 555 nm (was previously ColOptDepthUnc)	XDim, YDim, NAerMixtureDim	FLOAT32	n/a	n/a	-9999 = fill
OptDepthUpBd Optical depth upper bound	XDim, YDim, NAerMixtureDim	FLOAT32	n/a	n/a	-9999 = fill
OptDepthUpBdCam Camera used to establish optical depth upper bound	XDim, YDim, NAerMixtureDim	UINT8	n/a	n/a	253 = fill 1 = D forward 2 = C forward 3 = B forward 4 = A forward 5 = A nadir 6 = A aftward 7 = B aftward 8 = C aftward 9 = D aftward

Field Name Parameter Description	Dimension List	Number Type	Units	Transformation	Flag Values
OptDepthUpBdBand Band used to establish optical depth upper bound	XDim, YDim, NAerMixtureDim	UINT8	n/a	n/a	253 = fill 1 = Blue 2 = Green 3 = Red 4 = NIR
ChisqAbs Absolute chi-square	XDim, YDim, NAerMixtureDim	FLOAT32	n/a	n/a	-9999 = fill
ChisqGeom Geometric chi-square	XDim, YDim, NAerMixtureDim	FLOAT32	n/a	n/a	-9999 = fill
ChisqSpec Spectral chi-square	XDim, YDim, NAerMixtureDim	FLOAT32	n/a	n/a	-9999 = fill
ChisqMaxdev Maximum deviation chi-square	XDim, YDim, NAerMixtureDim	FLOAT32	n/a	n/a	-9999 = fill
ChisqHet Heterogeneous chi-square	XDim, YDim, NAerMixtureDim	FLOAT32	n/a	n/a	-9999 = fill
ChisqHomog Homogeneous chi-square	XDim, YDim, NAerMixtureDim	FLOAT32	n/a	n/a	-9999 = fill
OptDepthDWCalcPerBand Green optical depth retrieved from dark water algorithm, calculated per spectral band	XDim, YDim, NAerMixtureDim, NBandDim	FLOAT32	n/a	n/a	-9999 = fill
OptDepthOTACalcPerBand Green optical depth retrieved from OTA (optically thick atmosphere) algorithm, calculated per spectral band	XDim, YDim, NAerMixtureDim, NBandDim	FLOAT32	n/a	n/a	-9999 = fill
OptDepthHetCalcPerBand Green optical depth retrieved from heterogeneous surface algorithm, calculated per spectral band	XDim, YDim, NAerMixtureDim, NBandDim	FLOAT32	n/a	n/a	-9999 = fill
OptDepthHomogCalcPerBand Green optical depth retrieved from homogeneous surface algorithm, calculated per spectral band	XDim, YDim, NAerMixtureDim, NBandDim	FLOAT32	n/a	n/a	-9999 = fill
ChisqAbsCalcPerBand Absolute chi-square, computed per-band	XDim, YDim, NBandDim, NAerMixtureDim	FLOAT32	n/a	n/a	-9999 = fill
ChisqHetCalcPerBand Heterogeneous chi-square, computed per-band	XDim, YDim, NBandDim, NAerMixtureDim	FLOAT32	n/a	n/a	-9999 = fill

Field Name Parameter Description	Dimension List	Number Type	Units	Transformation	Flag Values
ChisqHomogCalcPerBand Homogeneous chi-square, computed per-band	XDim, YDim, NBandDim, NAerMixtureDim	FLOAT32	n/a	n/a	-9999 = fill
ColOzAbund Column ozone abundance	XDim, YDim	FLOAT32	Dobson	n/a	-9999 = fill
ColOzAbundSrc Ozone data source	XDim, YDim	UINT8	n/a	n/a	0 = no data available 1 = TASC -> DAO not available 2 = TASC -> DAO out of bounds 3 = DAO 253 = fill
SfcWindsp Surface wind speed	XDim, YDim	FLOAT32	m/s	n/a	-9999 = fill
SfcWindspSrc Wind speed data source	XDim, YDim	UINT8	n/a	n/a	0 = no data available 1 = TASC -> DAO not available 2 = TASC -> DAO out of bounds 3 = DAO 253 = fill
SfcPres Surface pressure	XDim, YDim	FLOAT32	hPa	n/a	-9999 = fill
SfcPresSrc Surface pressure data source	XDim, YDim	UINT8	n/a	n/a	0 = no data available 1 = TASC -> DAO not available 2 = TASC -> DAO out of bounds 3 = DAO 253 = fill
RegAltPres Atmospheric pressure at regional terrain altitude	XDim, YDim	FLOAT32	hPa	n/a	-9999 = fill
RegAltPresSrc Atmospheric pressure at regional terrain altitude data source	XDim, YDim	UINT8	n/a	n/a	0 = no data available 1 = TASC -> DAO not available 2 = TASC -> DAO out of bounds 3 = DAO 253 = fill
SfcAirTemp Surface air temperature	XDim, YDim	FLOAT32	K	n/a	-9999 = fill

Field Name Parameter Description	Dimension List	Number Type	Units	Transformation	Flag Values
SfcAirTempSrc Surface air temperature data source	XDim, YDim	UINT8	n/a	n/a	0 = no data available 1 = TASC -> DAO not available 2 = TASC -> DAO out of bounds 3 = DAO 253 = fill
RegAltAirTemp Air temperature at regional terrain altitude	XDim, YDim	FLOAT32	K	n/a	-9999 = fill
RegAltAirTempSrc Air temperature at regional terrain altitude data source	XDim, YDim	UINT8	n/a	n/a	0 = no data available 1 = TASC -> DAO not available 2 = TASC -> DAO out of bounds 3 = DAO 253 = fill
ColPrecipWater Column precipitable water	XDim, YDim	FLOAT32	mm	n/a	-9999 = fill
ColPrecipWaterSrc Column precipitable water data source	XDim, YDim	UINT8	n/a	n/a	0 = no data available 1 = TASC -> DAO not available 2 = TASC -> DAO out of bounds 3 = DAO -> MODIS not available 4 = DAO -> MODIS out of bounds 5 = MODIS 253 = fill
RelHumProfile Relative humidity profile (36 pressure levels)	XDim, YDim, NRelHumDim	FLOAT32	%	n/a	-9999 = fill
RelHumProfileSrc Relative humidity profile data source	XDim, YDim	UINT8	n/a	n/a	0 = No data available 3 = DAO 253 = fill

Field Name Parameter Description	Dimension List	Number Type	Units	Transformation	Flag Values
StratAerFlag Stratospheric aerosol flag	XDim, YDim	UINT8	n/a	n/a	0 = no retrieval 1 = determined from retrieval 2 = input from external source and used during retrieval 3 = input from external source and reported only 4 = determined from retrieval but also input from external source and reported 253 = fill
StratAerOptDepth Stratospheric aerosol optical depth	XDim, YDim	FLOAT32	n/a	n/a	-9999 = fill
StratAerOptDepthSrc Stratospheric aerosol data source	XDim, YDim	UINT8	n/a	n/a	0 = no retrieval 5 = MODIS -> SAGE III not available 6 = MODIS -> SAGE III out of bounds 7 = SAGE III 253 = fill
CirrFlag Cirrus flag	XDim, YDim	UINT8	n/a	n/a	0 = no retrieval 1 = determined from retrieval 2 = input from external source and used during retrieval 3 = input from external source and reported only 4 = determined from retrieval but also input from external source and reported 253 = fill
CirrOptDepth Cirrus optical depth	XDim, YDim	FLOAT32	n/a	n/a	-9999 = fill

Field Name Parameter Description	Dimension List	Number Type	Units	Transformation	Flag Values
CirrOptDepthSrc Cirrus data source	XDim, YDim	UINT8	n/a	n/a	0 = no retrieval 1 = MISR TOA/Cloud Product 2 = MODIS 3 = none (MODIS not available) 4 = none (MODIS out of bounds) 253 = fill
Grid DomParamsAer (Spatial Resolution: 70.4 km x 70.4 km, XDim = 2, YDim = 8)					
DomMeanOptDepth Mean optical depth over a domain	XDim, YDim	FLOAT32	n/a	n/a	-9999 = fill
DomMedOptDepth Median optical depth over a domain	XDim, YDim	FLOAT32	n/a	n/a	-9999 = fill
OptDepthHistogram Histogram of optical depths, per mixture	XDim, YDim, NAerMixtureDim, NTauBinDim	UINT8	n/a	n/a	253 = fill

8.4.8 Per-grid QA Metadata

Table 8-10: Per-grid QA Metadata for Aerosol Products.

Data Field Name	Data Type	Field Dimensions	Valid Range
Swath-level Constructs			
NRegWAnyGoodDwSub Number of regions containing at least one good (non-fill) dark water subregion.	INT32	--	0-36,352
NRegWNoGoodDwSub Number of regions containing no good (non-fill) dark water subregions, but containing at least one good (non-fill) other subregion.	INT32	--	0-36,352
NSubWGoodData Number of subregions containing good (non-fill) data.	INT32	--	0-36,352
NPixEqRefNoCorrect Number of 1.1 km x 1.1 km pixels to which a spectral out-of-band correction was not applied.	INT32	NCamDim	0-9,306,112

Data Field Name	Data Type	Field Dimensions	Valid Range
NRegDwAlgProcSw Number of regions processed with the aerosol retrieval algorithm for a dark water surface.	INT32	--	0-36,352
NRegDwAlgSuccSw Number of regions processed with the aerosol retrieval algorithm for a dark water surface, with a successful retrieval result.	INT32	--	0-36,352
NRegOTAAlgProcSw Number of regions processed with the aerosol retrieval algorithm for an optically thick atmosphere.	INT32	--	0-36,352
NRegOTAAlgSuccSw Number of regions processed with the aerosol retrieval algorithm for an optically thick atmosphere, with a successful retrieval result.	INT32	--	0-36,352
NRegEofAlgProcSw Number of regions processed with the aerosol retrieval algorithm for a heterogeneous land surface.	INT32	--	0-36,352
NRegEofAlgSuccSw Number of regions processed with the aerosol retrieval algorithm for a heterogeneous land surface, with a successful retrieval result.	INT32	--	0-36,352
NTauEqZero Number of regions for which the retrieved aerosol optical depth was zero.	INT32	NAerMixtureDim	0-36,352
NTauEqTauUpBd Number of regions for which the retrieved aerosol optical depth was equal to the optical depth upper bound.	INT32	NAerMixtureDim	0-36,352
NTauGreaterThanTauUpBd Number of regions for which the retrieved aerosol optical depth was greater than the optical depth upper bound.	INT32	NAerMixtureDim	0-36,352
Block-level Constructs			
BlockNumber Block number.	INT32	--	1-180
ValidRecord Indicates if valid data are present for the block.	UINT8	--	0,1
NRegWAnyGoodDWSub Number of regions containing at least one good (non-fill) dark water subregion.	INT32	--	0-256
NRegWNoGoodDWSub Number of regions containing no good (non-fill) dark water subregions, but containing at least one good (non-fill) other subregion.	INT32	--	0-256

Data Field Name	Data Type	Field Dimensions	Valid Range
NRegDwAlgProc Number of regions processed with the aerosol retrieval algorithm for a dark water surface.	INT32	--	0-256
NRegDwAlgSucc Number of regions processed with the aerosol retrieval algorithm for a dark water surface, with a successful retrieval result.	INT32	--	0-256
NRegOTAAlgProc Number of regions processed with the aerosol retrieval algorithm for an optically thick atmosphere	INT32	--	0-256
NRegOTAAlgSucc Number of regions processed with the aerosol retrieval algorithm for an optically thick atmosphere, with a successful retrieval result.	INT32	--	0-256
NRegEofAlgProc Number of regions processed with the aerosol retrieval algorithm for a heterogeneous land surface.	INT32	--	0-256
NRegEofAlgSucc Number of regions processed with the aerosol retrieval algorithm for a heterogeneous land surface, with a successful retrieval result.	INT32	--	0-256
NRegObliqueSunAng Number of regions not processed due to oblique solar illumination angle.	INT32	--	0-256
NRegTopoComplex Number of regions not processed due to regional topographic complexity.	INT32	--	0-256
NRegReglCloudy Number of regions not processed due to regional cloudiness.	INT32	--	0-256
NRegNoGoodSubData Number of regions not processed due to the absence of any good subregion data.	INT32	--	0-256
NRegOzDAOvailOOB Number of regions for which DAO ozone data are available but out-of-bounds.	INT32	--	0-256
NRegOzDAONotAvail Number of regions for which DAO ozone data are not available.	INT32	--	0-256
NRegWsDAOvailOOB Number of regions for which DAO wind speed data are available but out-of-bounds.	INT32	--	0-256

Data Field Name	Data Type	Field Dimensions	Valid Range
NRegWsDAONotAvail Number of regions for which DAO wind speed data are not available.	INT32	--	0-256
NRegPsDAOAvailOOB Number of regions for which DAO surface pressure data are available but out-of-bounds.	INT32	--	0-256
NRegPsDAONotAvail Number of regions for which DAO surface pressure data are not available.	INT32	--	0-256
NRegTsDAOAvailOOB Number of regions for which DAO surface temperature data are available but out-of-bounds.	INT32	--	0-256
NRegTsDAONotAvail Number of regions for which DAO surface temperature data are not available.	INT32	--	0-256
NRegGeopHtNotAvail Number of regions for which geopotential height data are not available.	INT32	--	0-256
NRegPtDAOCalcOOB Number of regions for which the pressure at terrain height calculated using DAO surface pressure data is out-of-bounds.	INT32	--	0-256
NRegTtDAOCalcOOB Number of regions for which the air temperature at terrain height calculated using DAO surface temperature data is out-of-bounds.	INT32	--	0-256
NRegCpwModAvailOOB Number of regions for which the MODIS column precipitable water amount is available but out-of-bounds.	INT32	--	0-256
NRegCpwModNotAvail Number of regions for which the MODIS column precipitable water amount is not available.	INT32	--	0-256
NRegCpwDAOAvailOOB Number of regions for which the DAO column precipitable water amount is available but out-of-bounds.	INT32	--	0-256
NRegCpwDAONotAvail Number of regions for which the DAO column precipitable water amount is not available.	INT32	--	0-256
NRegCirTCAvail Number of regions for which L2TC cirrus data are available.	INT32	--	0-256

Data Field Name	Data Type	Field Dimensions	Valid Range
NRegCirModAvailOOB Number of regions for which L2TC cirrus data are available but out-of-bounds.	INT32	--	0-256
NRegCirModNotAvail Number of regions for which MODIS cirrus data are not available.	INT32	--	0-256
NRegStrSagAvailOOB Number of regions for which stratospheric aerosol data from SAGE are available but out-of-bounds.	INT32	--	0-256
NRegStrSagNotAvail Number of regions for which stratospheric aerosol data from SAGE are not available.	INT32	--	0-256
NRegStrModAvailOOB Number of regions for which stratospheric aerosol data from MODIS are available but out-of-bounds.	INT32	--	0-256
NRegStrModNotAvail Number of regions for which stratospheric aerosol data from MODIS are not available.	INT32	--	0-256
NSubWGGoodData Number of subregions containing good (non-fill) data.	INT32	--	0-65,536
NTauEqZero Number of regions for which the retrieved aerosol optical depth was zero.	INT32	NAerMixtureDim	0-256
NTauEqTauUpBd Number of regions for which the retrieved aerosol optical depth was equal to the optical depth upper bound.	INT32	NAerMixtureDim	0-256
NTauGreaterThanTauUpBd Number of regions for which the retrieved aerosol optical depth was greater than the optical depth upper bound.	INT32	NAerMixtureDim	0-256
NPixEqReflNoCorrect Number of 1.1 km x 1.1 km pixels to which a spectral out-of-band correction was not applied.	INT32	NCamDim	0-262,144
NSubHighValEqReflBlue Number of subregions with high-valued equivalent reflectances in the blue band.	INT32	NCamDim	0-65,536
NSubHighValEqReflGreen Number of subregions with high-valued equivalent reflectances in the green band.	INT32	NCamDim	0-65,536
NSubHighValEqReflRed Number of subregions with high-valued equivalent reflectances in the red band.	INT32	NCamDim	0-65,536

Data Field Name	Data Type	Field Dimensions	Valid Range
NSubHighValEqReflNir Number of subregions with high-valued equivalent reflectances in the near-infrared band.	INT32	NCamDim	0-65,536
CloudMaskSrc Data source for cloud mask.	INT32	--	SDCM values available from MISR TOA/Cloud product Defaulted to Georectified Radiance Product RCCM
CloudShadowMaskSrc Data source for cloud shadow mask.	INT32	--	Cloud shadow mask available from MISR TOA/Cloud Product Cloud shadow mask not available
TopoShadowMaskSrc Data source for topographic shadow mask.	INT32	--	Topographic shadow mask available from MISR TOA/Cloud Product Topographic shadow mask not available
GeomDataQualInd Geometric calibration data quality indicator.	FLOAT64	--	-1 to 1

8.5 MISR LEVEL 2 MIL2ASLS LAND SURFACE PRODUCT

8.5.1 File Metadata Description

Table 8-11: File Metadata for Land Surface Product Files.

File Metadata Field Name	Definition	Data Type	Units	Valid Range
Path_number	Orbit path number	INT32	N/A	1-233
AGP_version_id	Version identifier for AGP	INT32	N/A	2
DID_version_id	Version identifier for DID (D TED [Digital Terrain Elevation Dataset] Intermediate Dataset)	INT32	N/A	4
Number_blocks	Total number of blocks	INT32	N/A	1-180
Ocean_blocks_size	Ocean_blocks.number dimension	INT32	N/A	1-180

File Metadata Field Name	Definition	Data Type	Units	Valid Range
Ocean_blocks.count	Total number of blocks containing entirely ocean radiances	INT32	N/A	1-180
Ocean_blocks.numbers	List of block numbers containing entirely ocean radiances	INT32	N/A	1-180
SOM_parameters.som_ellipsoid.a	Semimajor axis of ellipsoid	FLOAT64	meters	WGS84 ellipsoid
SOM_parameters.som_ellipsoid.e2	Eccentricity of ellipsoid squared	FLOAT64	N/A	WGS84 ellipsoid
SOM_parameters.som_orbit.aprime	Semimajor axis of orbit	FLOAT64	meters	Not used.
SOM_parameters.som_orbit.eprime	Eccentricity of orbit	FLOAT64	N/A	Not used.
SOM_parameters.som_orbit.gamma	Longitude of perigee	FLOAT64	radians	Not used.
SOM_parameters.som_orbit.nrev	Number of revolutions per ground track repeat cycle	INT32	N/A	233
SOM_parameters.som_orbit.ro	Radius of circular orbit	FLOAT64	meters	7.0780408E+06
SOM_parameters.som_orbit.i	Inclination of orbit (degrees)	FLOAT64	radians	1.7157253
SOM_parameters.som_orbit.P2P1	Ratio of time of revolution over length of Earth rotation/orbit	FLOAT64	N/A	6.8666667E-02
SOM_parameters.som_orbit.lambda0	Geodetic longitude of ascending node at time 0 (degrees)	FLOAT64	radians	-2pi to 2pi
Origin_block.ulc.x	SOM X coordinate (in meters) of the upper left corner of the first block	FLOAT64	meters	6 million to 33 million
Origin_block.ulc.y	SOM Y coordinate (in meters) of the upper left corner of the first block	FLOAT64	meters	+/- 12 million
Origin_block.lrc.x	SOM X coordinate (in meters) of the lower right corner of the first block	FLOAT64	meters	6 million to 33 million
Origin_block.lrc.y	SOM Y coordinate (in meters) of the lower right corner of the first block	FLOAT64	meters	+/- 12 million
Start_block	The block number in the AGP which corresponds to the first block in this file containing data.	INT32	N/A	1 - 180 Start_block < End block
End_block	The block number in the AGP which corresponds to the last block in this file containing data.	INT32	N/A	1 - 180 Start_block < End block

File Metadata Field Name	Definition	Data Type	Units	Valid Range
Cam_mode	Indicates whether the data in this grid file was obtained in MISR global mode or local mode.	INT32	N/A	0-1 1 = global 0 = local
Num_local_modes	The number of MISR local mode acquisitions contained in this file.	INT32	N/A	0-6 0 if data is global mode
Local_mode_site_name	The geographical name of the first local mode site contained in this file.	CHAR8	N/A	string up to 12 characters in length, including null
Orbit_QA	Indication of the overall quality of the orbit data based on analysis of quality flags in the spacecraft attitude and ephemeris data. Geolocation accuracy may be impaired for orbits with poor quality orbit data.	FLOAT32	N/A	-9999.0 = NoRetrieval, -1.0 = Poor, 0.0 = Nominal

8.5.2 Vdata Description

HDF vdatas are used in the land surface product as “flag legends,” which map flag values to their definitions. Flag legend vdatas consist of two fields called "Value" and "Description." The "Value" field is of type UINT8, and consists of one element. The "Description" field is of type CHAR8, and consists of 80 elements. There is one record per flag value. The flag legends are summarized below. To obtain the actual values of the flag values and descriptions, read the vdatas in the file, or refer to Table 8-16 in this document.

Table 8-12: Land Surface Product File Vdata Summary

Vdata Name	Records	Description
RDQI Flag Legend	One per flag value	Map flag values to descriptions
BiomeBestEstimate Flag Legend	One per flag value	Map flag values to descriptions
LAIBestEstimateQA Flag Legend	One per flag value	Map flag values to descriptions
LAIQA Flag Legend	One per flag value	Map flag values to descriptions

8.5.3 Per-grid Metadata Description

Table 8-13: Per-grid Metadata for Land Surface Product Files.

Common Grid Metadata	Definition	Data Type	Valid Values
Block_size.resolution_x	Resolution of block x dimension in meters	INT32	1100, 17600
Block_size.resolution_y	Resolution of block y dimension in meters	INT32	1100, 17600
Block_size.size_x	Block x dimension	INT32	128, 8
Block_size.size_y	Block y dimension	INT32	512, 32

Land Surface Grid Metadata	Definition	Data Type	Valid Values
<i>Land Surface SubregParams (1.1 km x 1.1 km)</i>			
Min LandHDRF	Minimum value for field	FLOAT32	Read from grid metadata in file.
Max LandHDRF	Maximum value for field	FLOAT32	Read from grid metadata in file.
Scale LandHDRF	Scale factor to apply	FLOAT32	Read from grid metadata in file.
Offset LandHDRF	Offset factor to apply	FLOAT32	Read from grid metadata in file.
Fill LandHDRF	Fill value for field	UINT16	Read from grid metadata in file.
Underflow LandHDRF	Underflow flag value	UINT16	Read from grid metadata in file.
Overflow LandHDRF	Overflow flag value	UINT16	Read from grid metadata in file.
Min LandHDRFUncCamAvg	Minimum value for field	FLOAT32	Read from grid metadata in file.
Max LandHDRFUncCamAvg	Maximum value for field	FLOAT32	Read from grid metadata in file.
Scale LandHDRFUncCamAvg	Scale factor to apply	FLOAT32	Read from grid metadata in file.
Offset LandHDRFUncCamAvg	Offset factor to apply	FLOAT32	Read from grid metadata in file.
Fill LandHDRFUncCamAvg	Fill value for field	UINT16	Read from grid metadata in file.
Underflow LandHDRFUncCamAvg	Underflow flag value	UINT16	Read from grid metadata in file.
Overflow LandHDRFUncCamAvg	Overflow flag value	UINT16	Read from grid metadata in file.
Min LandBHR	Minimum value for field	FLOAT32	Read from grid metadata in file.
Max LandBHR	Maximum value for field	FLOAT32	Read from grid metadata in file.
Scale LandBHR	Scale factor to apply	FLOAT32	Read from grid metadata in file.

Land Surface Grid Metadata	Definition	Data Type	Valid Values
Offset LandBHR	Offset factor to apply	FLOAT32	Read from grid metadata in file.
Fill LandBHR	Fill value for field	UINT8	Read from grid metadata in file.
Underflow LandBHR	Underflow flag value	UINT8	Read from grid metadata in file.
Overflow LandBHR	Overflow flag value	UINT8	Read from grid metadata in file.
Min LandBHRRelUnc	Minimum value for field	FLOAT32	Read from grid metadata in file.
Max LandBHRRelUnc	Maximum value for field	FLOAT32	Read from grid metadata in file.
Scale LandBHRRelUnc	Scale factor to apply	FLOAT32	Read from grid metadata in file.
Offset LandBHRRelUnc	Offset factor to apply	FLOAT32	Read from grid metadata in file.
Fill LandBHRRelUnc	Fill value for field	UINT8	Read from grid metadata in file.
Underflow LandBHRRelUnc	Underflow flag value	UINT8	Read from grid metadata in file.
Overflow LandBHRRelUnc	Overflow flag value	UINT8	Read from grid metadata in file.
Min LandBRF	Minimum value for field	FLOAT32	Read from grid metadata in file.
Max LandBRF	Maximum value for field	FLOAT32	Read from grid metadata in file.
Scale LandBRF	Scale factor to apply	FLOAT32	Read from grid metadata in file.
Offset LandBRF	Offset factor to apply	FLOAT32	Read from grid metadata in file.
Fill LandBRF	Fill value for field	UINT16	Read from grid metadata in file.
Underflow LandBRF	Underflow flag value	UINT16	Read from grid metadata in file.
Overflow LandBRF	Overflow flag value	UINT16	Read from grid metadata in file.
Min LandDHR	Minimum value for field	FLOAT32	Read from grid metadata in file.
Max LandDHR	Maximum value for field	FLOAT32	Read from grid metadata in file.
Scale LandDHR	Scale factor to apply	FLOAT32	Read from grid metadata in file.
Offset LandDHR	Offset factor to apply	FLOAT32	Read from grid metadata in file.
Fill LandDHR	Fill value for field	UINT16	Read from grid metadata in file.
Underflow LandDHR	Underflow flag value	UINT16	Read from grid metadata in file.
Overflow LandDHR	Overflow flag value	UINT16	Read from grid metadata in file.
Min BRFModParam1	Minimum value for field	FLOAT32	Read from grid metadata in file.
Max BRFModParam1	Maximum value for field	FLOAT32	Read from grid metadata in file.
Scale BRFModParam1	Scale factor to apply	FLOAT32	Read from grid metadata in file.
Offset BRFModParam1	Offset factor to apply	FLOAT32	Read from grid metadata in file.
Fill BRFModParam1	Fill value for field	UINT16	Read from grid metadata in file.
Underflow BRFModParam1	Underflow flag value	UINT16	Read from grid metadata in file.

Land Surface Grid Metadata	Definition	Data Type	Valid Values
Overflow BRFFModParam1	Overflow flag value	UINT16	Read from grid metadata in file.
Min BRFFModParam2	Minimum value for field	FLOAT32	Read from grid metadata in file.
Max BRFFModParam2	Maximum value for field	FLOAT32	Read from grid metadata in file.
Scale BRFFModParam2	Scale factor to apply	FLOAT32	Read from grid metadata in file.
Offset BRFFModParam2	Offset factor to apply	FLOAT32	Read from grid metadata in file.
Fill BRFFModParam2	Fill value for field	UINT8	Read from grid metadata in file.
Underflow BRFFModParam2	Underflow flag value	UINT8	Read from grid metadata in file.
Overflow BRFFModParam2	Overflow flag value	UINT8	Read from grid metadata in file.
Min BRFFModParam3	Minimum value for field	FLOAT32	Read from grid metadata in file.
Max BRFFModParam3	Maximum value for field	FLOAT32	Read from grid metadata in file.
Scale BRFFModParam3	Scale factor to apply	FLOAT32	Read from grid metadata in file.
Offset BRFFModParam3	Offset factor to apply	FLOAT32	Read from grid metadata in file.
Fill BRFFModParam3	Fill value for field	UINT8	Read from grid metadata in file.
Underflow BRFFModParam3	Underflow flag value	UINT8	Read from grid metadata in file.
Overflow BRFFModParam3	Overflow flag value	UINT8	Read from grid metadata in file.
Min BRFFModFitResid	Minimum value for field	FLOAT32	Read from grid metadata in file.
Max BRFFModFitResid	Maximum value for field	FLOAT32	Read from grid metadata in file.
Scale BRFFModFitResid	Scale factor to apply	FLOAT32	Read from grid metadata in file.
Offset BRFFModFitResid	Offset factor to apply	FLOAT32	Read from grid metadata in file.
Fill BRFFModFitResid	Fill value for field	UINT16	Read from grid metadata in file.
Underflow BRFFModFitResid	Underflow flag value	UINT16	Read from grid metadata in file.
Overflow BRFFModFitResid	Overflow flag value	UINT16	Read from grid metadata in file.
Min NDVI	Minimum value for field	FLOAT32	Read from grid metadata in file.
Max NDVI	Maximum value for field	FLOAT32	Read from grid metadata in file.
Scale NDVI	Scale factor to apply	FLOAT32	Read from grid metadata in file.
Offset NDVI	Offset factor to apply	FLOAT32	Read from grid metadata in file.
Fill NDVI	Fill value for field	UINT8	Read from grid metadata in file.
Underflow NDVI	Underflow flag value	UINT8	Read from grid metadata in file.
Overflow NDVI	Overflow flag value	UINT8	Read from grid metadata in file.
Min LAIMean1	Minimum value for field	FLOAT32	Read from grid metadata in file.
Max LAIMean1	Maximum value for field	FLOAT32	Read from grid metadata in file.

Land Surface Grid Metadata	Definition	Data Type	Valid Values
Scale LAIMean1	Scale factor to apply	FLOAT32	Read from grid metadata in file.
Offset LAIMean1	Offset factor to apply	FLOAT32	Read from grid metadata in file.
Fill LAIMean1	Fill value for field	UINT8	Read from grid metadata in file.
Underflow LAIMean1	Underflow flag value	UINT8	Read from grid metadata in file.
Overflow LAIMean1	Overflow flag value	UINT8	Read from grid metadata in file.
Min LAIDelta1	Minimum value for field	FLOAT32	Read from grid metadata in file.
Max LAIDelta1	Maximum value for field	FLOAT32	Read from grid metadata in file.
Scale LAIDelta1	Scale factor to apply	FLOAT32	Read from grid metadata in file.
Offset LAIDelta1	Offset factor to apply	FLOAT32	Read from grid metadata in file.
Fill LAIDelta1	Fill value for field	UINT8	Read from grid metadata in file.
Underflow LAIDelta1	Underflow flag value	UINT8	Read from grid metadata in file.
Overflow LAIDelta1	Overflow flag value	UINT8	Read from grid metadata in file.
Min LAIMean2	Minimum value for field	FLOAT32	Read from grid metadata in file.
Max LAIMean2	Maximum value for field	FLOAT32	Read from grid metadata in file.
Scale LAIMean2	Scale factor to apply	FLOAT32	Read from grid metadata in file.
Offset LAIMean2	Offset factor to apply	FLOAT32	Read from grid metadata in file.
Fill LAIMean2	Fill value for field	UINT8	Read from grid metadata in file.
Underflow LAIMean2	Underflow flag value	UINT8	Read from grid metadata in file.
Overflow LAIMean2	Overflow flag value	UINT8	Read from grid metadata in file.
Min LAIDelta2	Minimum value for field	FLOAT32	Read from grid metadata in file.
Max LAIDelta2	Maximum value for field	FLOAT32	Read from grid metadata in file.
Scale LAIDelta2	Scale factor to apply	FLOAT32	Read from grid metadata in file.
Offset LAIDelta2	Offset factor to apply	FLOAT32	Read from grid metadata in file.
Fill LAIDelta2	Fill value for field	UINT8	Read from grid metadata in file.
Underflow LAIDelta2	Underflow flag value	UINT8	Read from grid metadata in file.
Overflow LAIDelta2	Overflow flag value	UINT8	Read from grid metadata in file.
Min SubrVar	Minimum value for field	FLOAT32	Read from grid metadata in file.
Max SubrVar	Maximum value for field	FLOAT32	Read from grid metadata in file.
Scale SubrVar	Scale factor to apply	FLOAT32	Read from grid metadata in file.
Offset SubrVar	Offset factor to apply	FLOAT32	Read from grid metadata in file.
Fill SubrVar	Fill value for field	UINT8	Read from grid metadata in file.

Land Surface Grid Metadata	Definition	Data Type	Valid Values
Underflow SubrVar	Underflow flag value	UINT8	Read from grid metadata in file.
Overflow SubrVar	Overflow flag value	UINT8	Read from grid metadata in file.

8.5.4 Per-block Metadata Description

Table 8-14: Per-block Metadata for Land Surface Product Files.

PerBlockMetadataCommon	Definition	Data Type	Valid Values
Block_number	Current block number	INT32	1-180
Ocean_flag	Flag signalling whether the block contains entirely ocean radiances	INT8	0 = block has no ocean or is a mix of ocean and land 1 = block is entirely ocean
Block_coor_ulc_som_meter.x	Upper left corner SOM block x coordinate in meters	FLOAT64	
Block_coor_ulc_som_meter.y	Upper left corner SOM block y coordinate in meters	FLOAT64	
Block_coor_lrc_som_meter.x	Lower right corner SOM block x coordinate in meters	FLOAT64	
Block_coor_lrc_som_meter.y	Lower right corner SOM block y coordinate in meters	FLOAT64	
Data_flag	Flag signalling whether the block contains entirely fill data	INT8	0 = block contains entirely fill data 1 = block contains valid data

Common Per Block Metadata	Definition	Data Type	Valid Values
Geometric DQI	Geometric Data Quality Indicator copied from the L1B2 Terrain-projected parameter file.	FLOAT64	-1 to 1

8.5.5 Per-line Metadata Description

None.

8.5.6 Per-pixel Metadata Description

None.

8.5.7 Grid Data Set Descriptions

In order to minimize storage for the Aerosol/Surface Product, some parameters will be packed so that each bit represents a logical value, or some number of bits within a byte or word represent a flag value. Floating point values and integer values may take on a flag value indicating invalid data. Currently, there is a flag value of -9999.0, representing missing floating point data; a flag value of 253, representing missing data for unsigned 8-bit integers; a flag value of 65533, representing missing data for unsigned 16-bit integers; and a flag value of -32768, representing missing data for 16-bit signed integers. In addition, there are flag values representing underflow and overflow. There is a flag value of 254, representing underflow for unsigned 8-bit integers; a flag value of 255, representing overflow for unsigned 8-bit integers; a flag value of 65534, representing underflow for unsigned 16-bit integers; a flag value of 65535, representing overflow for unsigned 16-bit integers; a flag value of -32767, representing underflow for 16-bit signed integers; and a flag value of 32767, representing overflow for 16-bit signed integers. Note that we may later add more flag values to distinguish other reasons that the data are missing (e.g. never computed, arithmetic error, etc.).

Some parameters are stored in scaled form. The equation for transforming them back to their unscaled form is described in the ‘Transformation’ column of Table 8-16. The scale and offset parameters referred to in the ‘Transformation’ column are stored in the grid metadata.

Table 8-15: Land Surface Product Field Dimension Descriptions

Dimension	Description	Valid Values
SOMBlockDim	<i>SOMBlockDim</i> is the number of SOM blocks in the file. The slowest-varying dimension is implicitly the SOM block dimension. It is not shown in the tables below.	- for the Aerosol and Land Surface files this can vary, with a typical value being approximately 140 - for the Ocean Surface file this will be 6
XDim	<i>XDim</i> is the number of lines in a block. The x dimension direction is identical to the standard SOM x dimension.	128 for 1.1 km parameters or 8 for 17.6 km parameters
YDim	<i>YDim</i> is the number of samples in a block. The y dimension direction is identical to the standard SOM y dimension.	512 for 1.1 km parameters or 32 for 17.6 km parameters

Table 8-15: Land Surface Product Field Dimension Descriptions (Continued)

Dimension	Description	Valid Values
NCamDim	<i>NCamDim</i> is the number of MISR cameras.	9 where 1 = D forward 2 = C forward 3 = B forward 4 = A forward 5 = A nadir 6 = A aftward 7 = B aftward 8 = C aftward 9 = D aftward
NBandDim	<i>NBandDim</i> is the number of bands in a MISR camera.	4 where 1 = Blue 2 = Green 3 = Red 4 = NIR
NFparSfcTypeTotDim	<i>NFparSfcTypeTotDim</i> is the total number of FPAR surface types.	10 where 1 = Grasses and cereal crops 2 = Shrubland 3 = Broadleaf crops 4 = Savanna 5 = Broadleaf forest 6 = Needleleaf forest 7 = Unknown 8 = Ambiguous 9 = Not land 10 = Barren
NFparSfcTypeVegDim	<i>NFparSfcTypeVegDim</i> is the number of vegetative FPAR surface types.	6 where 1 = Grasses and cereal crops 2 = Shrubland 3 = Broadleaf crops 4 = Savanna 5 = Broadleaf forest 6 = Needleleaf forest

Table 8-16: Land Surface Product Grid Dataset Descriptions.

Field Name Parameter Description	Dimension List	Number Type	Units	Transformation a	Flag Values
Grid SubregParamsLnd (Spatial Resolution: 1.1 km x 1.1 km, XDim = 128, YDim = 512)					

Field Name Parameter Description	Dimension List	Number Type	Units	Transformation ^a	Flag Values
LandHDRF Land HDRF	XDim, YDim, NBandDim, NCamDim	UINT16	n/a	If the HDRF value is not fill, overflow or underflow, do the following: Right-shift the HDRF value one bit, to remove the least significant bit, which is a flag value, leaving a 15-bit number. ^b Use this 15-bit number below: $y=(x*\text{Scale LandHDRF}) + \text{Offset LandHDRF}$	65533 = fill 65534 = underflow 65535 = overflow least significant bit: '0' indicates that HDRF results were obtained using the original (non-interpolated) equivalent reflectances as input. '1' indicates that HDRF results were obtained using interpolated equivalent reflectances as input.
LandHDRFUncCamAvg Camera-averaged HDRF uncertainty	XDim, YDim, NBandDim	UINT16	n/a	$y=(x*\text{Scale LandHDRFUncCamAvg}) + \text{Offset LandHDRFUncCamAvg}$	65533 = fill 65534 = underflow 65535 = overflow
RDQI Radiometric Data Quality Indicator	XDim, YDim, NBandDim, NCamDim	UINT8	n/a	n/a	0 = Within specifications 1 = Reduced accuracy 2 = Not usable for science 3 = Unusable for any purpose 253 = fill <i>Note that for land surface processing, only radiance values $\leq RDQI_1$ are considered acceptable for use in processing. $RDQI_1$ is a threshold specified in the L2AS Config file, in the Land Surface section.</i>
LandBHR Land BHR	XDim, YDim, NBandDim	UINT8	n/a	$y=(x*\text{Scale LandBHR}) + \text{Offset LandBHR}$	253 = fill 254 = underflow 255 = overflow
LandBHRRelUnc BHR relative uncertainty	XDim, YDim, NBandDim	UINT8	n/a	$y=(x*\text{Scale LandBHRRelUnc}) + \text{Offset LandBHRRelUnc}$	253 = fill 254 = underflow 255 = overflow

Field Name Parameter Description	Dimension List	Number Type	Units	Transformation ^a	Flag Values
LandBRF Land BRF	XDim, YDim, NBandDim, NCamDim	UINT16	n/a	If the BRF value is not fill, overflow or underflow, do the following: Right-shift the BRF value one bit, to remove the least significant bit, which is a flag value, leaving a 15-bit number. ^c Use this 15-bit number below: $y=(x \times \text{Scale LandBRF}) + \text{Offset LandBRF}$	65533 = fill 65534 = underflow 65535 = overflow least significant bit: ‘0’ indicates that BRF results were obtained using the original (non-interpolated) equivalent reflectances as input. ‘1’ indicates that BRF results were obtained using interpolated equivalent reflectances as input.
LandDHR Land DHR	XDim, YDim, NBandDim	UINT8	n/a	$y=(x \times \text{Scale LandDHR}) + \text{Offset LandDHR}$	253 = fill 254 = underflow 255 = overflow
BRFModParam1 1st BRF model parameter, r0 in Eq. 78, Level 2 Surface Retrieval ATBD	XDim, YDim, NBandDim	UINT16	n/a	$y=(x \times \text{Scale BRFModParam1}) + \text{Offset BRFModParam1}$	65533 = fill 65534 = underflow 65535 = overflow
BRFModParam2 2nd BRF model parameter, k in Eq. 78, Level 2 Surface Retrieval ATBD	XDim, YDim, NBandDim	UINT8	n/a	$y=(x \times \text{Scale BRFModParam2}) + \text{Offset BRFModParam2}$	253 = fill 254 = underflow 255 = overflow
BRFModParam3 3rd BRF model parameter, b in Eq. 78, Level 2 Surface Retrieval ATBD	XDim, YDim, NBandDim	UINT8	n/a	$y=(x \times \text{Scale BRFModParam3}) + \text{Offset BRFModParam3}$	253 = fill 254 = underflow 255 = overflow
BRFModFitResid BRF model fit residuals, Δ in Eq. 89a, Level 2 Surface Retrieval ATBD	XDim, YDim, NBandDim	UINT16	n/a	$y=(x \times \text{Scale BRFModFitResid}) + \text{Offset BRFModFitResid}$	65533 = fill 65534 = underflow 65535 = overflow
NDVI NDVI	XDim, YDim	UINT8	n/a	$y=(x \times \text{Scale NDVI}) + \text{Offset NDVI}$	253 = fill 254 = underflow 255 = overflow
BiomeBestEstimate Best estimate of biome type	XDim, YDim	UINT8	n/a	n/a	253 = fill 1 = Grasses and cereal crops 2 = Shrubland 3 = Broadleaf crops 4 = Savanna 5 = Broadleaf forest 6 = Needleleaf forest 7 = Unknown 8 = Ambiguous 9 = Not land 10 = Barren

Field Name Parameter Description	Dimension List	Number Type	Units	Transformation ^a	Flag Values
BiomeBestEstimateQA QA indicator for best estimate of biome type (<i>not yet computed; currently set to fill everywhere</i>)	XDim, YDim	UINT8	n/a	n/a	253 = fill
LAIBestEstimate Best estimate of LAI,	XDim, YDim	FLOAT32	n/a	n/a	-9999 = fill
LAIBestEstimateQA QA indicator for best estimate of LAI	XDim, YDim	UINT8	n/a	n/a	253 = fill 0 = LAI tests 1 and 2 passed 1 = LAI test 1 passed, LAI test 2 failed 2 = LAI test 1 failed, LAI test 2 passed (<i>not used</i>) 3 = LAI test 1 failed, LAI test 2 not attempted 4 = LAI tests not attempted due to poor solar, viewing geometry
FPARBestEstimate Best estimate of FPAR	XDim, YDim	FLOAT32	n/a	n/a	-9999 = fill
BHRPAR BHR(PAR)	XDim, YDim	FLOAT32	n/a	n/a	-9999 = fill
DHRPAR DHR(PAR)	XDim, YDim	FLOAT32	n/a	n/a	-9999 = fill
LAIMean1 Mean LAI, first test (6 biomes)	XDim, YDim, NFparSfcTypeVeg Dim	UINT8	n/a	$y=(x* \text{Scale LAIMean1})+ \text{Offset LAIMean1}$	253 = fill 254 = underflow 255 = overflow
LAIDelta1 Delta LAI, first test (6 biomes)	XDim, YDim, NFparSfcTypeVeg Dim	FLOAT32	n/a	n/a	-9999 = fill
LAINumGoodFit1 Number of good fits after first test (6 biomes)	XDim, YDim, NFparSfcTypeVeg Dim	UINT8	n/a	n/a	253 = fill
LAIMean2 Mean LAI, second test (6 biomes)	XDim, YDim, NFparSfcTypeVeg Dim	UINT8	n/a	$y=(x* \text{Scale LAIMean2})+ \text{Offset LAIMean2}$	253 = fill 254 = underflow 255 = overflow

Field Name Parameter Description	Dimension List	Number Type	Units	Transformation ^a	Flag Values
LAIDelta2 Delta LAI, second test (6 biomes)	XDim, YDim, NFparSfcTypeVeg Dim	FLOAT32	n/a	n/a	-9999 = fill
LAINumGoodFit2 Number of good fits after second test (6 biomes)	XDim, YDim, NFparSfcTypeVeg Dim	UINT8	n/a	n/a	253 = fill
LAIQA QA indicator for LAI	XDim, YDim, NFparSfcTypeVeg Dim	UINT8	n/a	n/a	253 = fill 0 = LAI tests 1 and 2 passed 1 = LAI test 1 passed, LAI test 2 failed 2 = LAI test 1 failed, LAI test 2 passed (<i>not used</i>) 3 = LAI test 1 failed, LAI test 2 not attempted 4 = LAI tests not attempted due to poor solar, viewing geometry
SubrVar Subregion variability	XDim, YDim, NBandDim	UINT8	n/a	$y=(x*Scale\ SubrVar)+Offset\ SubrVar$	253 = fill 254 = underflow 255 = overflow
Grid RegParamsLnd (Spatial Resolution: 17.6 km x 17.6 km, XDim = 8, YDim = 32)					
NormBlkSfclrrad Normalized black surface irradiance	XDim, YDim, NBandDim	FLOAT32	n/a	n/a	-9999 = fill
NormBlkSfclrradUnc Normalized black surface irradiance uncertainty	XDim, YDim, NBandDim	FLOAT32	n/a	n/a	-9999 = fill
BOABihemAlb BOA bihemispherical albedo	XDim, YDim, NBandDim	FLOAT32	n/a	n/a	-9999 = fill
BOABihemAlbUnc BOA bihemispherical albedo uncertainty	XDim, YDim, NBandDim	FLOAT32	n/a	n/a	-9999 = fill
RegSfcRetrOptDepth Aerosol optical depth to be used in the land surface retrieval	XDim, YDim	FLOAT32	n/a	n/a	-9999 = fill
RegSfcRetrOptDepthUnc Uncertainty in aerosol optical depth to be used in the land surface retrieval	XDim, YDim	FLOAT32	n/a	n/a	-9999 = fill

Field Name Parameter Description	Dimension List	Number Type	Units	Transformation ^a	Flag Values
RegSfcRetrMixture Aerosol mixture to be used in the land surface retrieval	XDim, YDim	UINT8	n/a	n/a	253 = fill
RegSfcRetrAlgTypeFlag Algorithm type used to compute aerosol mixture and optical depth	XDim, YDim	UINT8	n/a	n/a	253 = fill

- a. Scale and offset values can be read from the grid metadata, and are also listed in Table 8-13.
- b. Performing a right shift is roughly equal to dividing by 2.
- c. Performing a right shift is roughly equal to dividing by 2.

8.5.8 Per-grid QA Metadata

Table 8-17: Per-grid QA Metadata for Land Surface Products.

Data Field Name	Data Type	Field Dimensions	Valid Range
<i>Swath-level Constructs</i>			
NSubLandAlgProcSw Number of subregions processed with the land surface algorithms.	INT32	--	0-9,306,112
NSubSuccHdrfBhrSw Number of subregions with a successful HDRF/BHR retrieval.	INT32	NBandDim	0-9,306,112
NSubSuccBrfDhrSw Number of subregions with a successful BRF/DHR model parameter retrieval.	INT32	NBandDim	0-9,306,112
NSubSuccBiomeLaiSw Number of subregions with a successful LAI (leaf area index) retrieval.	INT32	--	0-9,306,112
NRegWAnyGoodLndSub Number of regions containing at least one good (non-fill) land subregion.	INT32	--	0-36,352
NRegLandAlgProcSw Number of regions processed with the land surface algorithms.	INT32	--	0-36,352
NSubSuccPARIntBhrSw Number of subregions with a successful PAR-integrated BHR retrieval.	INT32	--	0-9,306,112
NSubSuccPARIntDhrSw Number of subregions with a successful PAR-integrated DHR retrieval.	INT32	--	0-9,306,112

Data Field Name	Data Type	Field Dimensions	Valid Range
NSubSuccFPARSw Number of subregions with a successful FPAR retrieval.	INT32	--	0-9,306,112
Block-level Constructs			
BlockNumber Block number.	INT32	--	1-180
ValidRecord Indicates if valid data are present for the block.	UINT8	--	0,1
NRegWAnyGoodLndSub Number of regions containing at least one good (non-fill) land subregion.	INT32	--	0-256
NSubWGoodLndData Number of subregions containing good (non-fill) land data.	INT32	--	0-65,536
NSubLandAlgProc Number of subregions processed with the land surface algorithms.	INT32	--	0-65,536
NSubSuccHdrfBhr Number of subregions with a successful HDRF/BHR retrieval.	INT32	NBandDim	0-65,536
NSubSuccBrfDhr Number of subregions with a successful BRf/DHR/BRF model parameter retrieval.	INT32	NBandDim	0-65,536
NSubSuccBiomeLai Number of subregions with a successful LAI (leaf area index) retrieval.	INT32	--	0-65,536
NSubCIBarren Number of subregions with a biome classification of Barren.	INT32	--	0-65,536
NSubCIWater Number of subregions with a biome classification of Water.	INT32	--	0-65,536
NSubCIGrassCerCrop Number of subregions with a biome classification of Grasses and Cereal Crops.	INT32	--	0-65,536
NSubCISemiAridShrb Number of subregions with a biome classification of Semi-arid Shrubland.	INT32	--	0-65,536
NSubCIBroadlfcrop Number of subregions with a biome classification of Broadleaf Crop.	INT32	--	0-65,536
NSubCISavanna Number of subregions with a biome classification of Savanna.	INT32	--	0-65,536
NSubCIBroadlffor Number of subregions with a biome classification of Broadleaf Forest.	INT32	--	0-65,536

Data Field Name	Data Type	Field Dimensions	Valid Range
NSubCINeedlelfFor Number of subregions with a biome classification of Needleleaf Forest.	INT32	--	0-65,536
NSubCIUnknown Number of subregions with a biome classification of Unknown.	INT32	--	0-65,536
NRegLandAlgProc Number of regions processed with the land surface algorithms.	INT32	--	0-256
NSubSuccPARIntBhr Number of subregions with a successful PAR-integrated BHR retrieval.	INT32	--	0-65,536
NSubSuccPARIntDhr Number of subregions with a successful PAR-integrated DHR retrieval.	INT32	--	0-65,536
NSubSuccFPAR Number of subregions with a successful FPAR retrieval.	INT32	--	0-65,536
GeomDataQualInd Geometric calibration data quality indicator.	FLOAT64	--	-1 to 1

8.6 MISR LEVEL 2 MIL2ASOS OCEAN SURFACE PRODUCT

8.6.1 File Metadata Description

Table 8-18: File Metadata for Ocean Surface Product Files.

File Metadata Field Name	Definition	Data Type	Units	Valid Range
Path_number	Orbit path number	INT32	N/A	1-233
AGP_version_id	Version identifier for AGP	INT32	N/A	2
DID_version_id	Version identifier for DID (<u>D</u> TED [Digital Terrain Elevation Dataset] <u>I</u> ntermediate <u>D</u> ataset)	INT32	N/A	4
Number_blocks	Total number of blocks	INT32	N/A	1-180
Ocean_blocks_size	Ocean_blocks.number dimension	INT32	N/A	1-180
Ocean_blocks.count	Total number of blocks containing entirely ocean radiances	INT32	N/A	1-180

File Metadata Field Name	Definition	Data Type	Units	Valid Range
Ocean_blocks.numbers	List of block numbers containing entirely ocean radiances	INT32	N/A	1-180
SOM_parameters.som_ellipsoid.a	Semimajor axis of ellipsoid	FLOAT64	meters	WGS84 ellipsoid (6.3781370E+06)
SOM_parameters.som_ellipsoid.e2	Eccentricity of ellipsoid squared	FLOAT64	N/A	WGS84 ellipsoid (6.6943480E-03)
SOM_parameters.som_orbit.aprime	Semimajor axis of orbit	FLOAT64	meters	Not used.
SOM_parameters.som_orbit.eprime	Eccentricity of orbit	FLOAT64	N/A	Not used.
SOM_parameters.som_orbit.gamma	Longitude of perigee	FLOAT64	radians	Not used.
SOM_parameters.som_orbit.nrev	Number of revolutions per ground track repeat cycle	INT32	N/A	233
SOM_parameters.som_orbit.ro	Radius of circular orbit	FLOAT64	meters	7.0780408E+06
SOM_parameters.som_orbit.i	Inclination of orbit (degrees)	FLOAT64	radians	1.7157253
SOM_parameters.som_orbit.P2P1	Ratio of time of revolution over length of Earth rotation/orbit	FLOAT64	N/A	6.8666667E-02
SOM_parameters.som_orbit.lambda0	Geodetic longitude of ascending node at time 0 (degrees)	FLOAT64	radians	-2pi to 2pi
Origin_block.ulc.x	SOM X coordinate (in meters) of the upper left corner of the first block	FLOAT64	meters	6 million to 33 million
Origin_block.ulc.y	SOM Y coordinate (in meters) of the upper left corner of the first block	FLOAT64	meters	+/- 12 million
Origin_block.lrc.x	SOM X coordinate (in meters) of the lower right corner of the first block	FLOAT64	meters	6 million to 33 million
Origin_block.lrc.y	SOM Y coordinate (in meters) of the lower right corner of the first block	FLOAT64	meters	+/- 12 million
Start_block	The block number in the AGP which corresponds to the first block in this file containing data.	INT32	N/A	1 - 180 Start_block < End block
End_block	The block number in the AGP which corresponds to the last block in this file containing data.	INT32	N/A	1 - 180 Start_block < End block

File Metadata Field Name	Definition	Data Type	Units	Valid Range
Cam_mode	Indicates whether the data in this grid file was obtained in MISR global mode or local mode.	INT32	N/A	0-1 1 = global 0 = local
Num_local_modes	The number of MISR local mode acquisitions contained in this file.	INT32	N/A	0-6 0 if data is global mode
Local_mode_site_name	The geographical name of the first local mode site contained in this file.	CHAR8	N/A	string up to 12 characters in length, including null
Orbit_QA	Indication of the overall quality of the orbit data based on analysis of quality flags in the spacecraft attitude and ephemeris data. Geolocation accuracy may be impaired for orbits with poor quality orbit data.	FLOAT32	N/A	-9999.0 = NoRetrieval, -1.0 = Poor, 0.0 = Nominal

8.6.2 Per-grid Metadata Description

Table 8-19: Per-grid Metadata for Ocean Surface Product Files.

Common Grid Metadata	Definition	Data Type	Valid Values
Block_size.resolution_x	Resolution of block x dimension in meters	INT32	1100, 17600
Block_size.resolution_y	Resolution of block y dimension in meters	INT32	1100, 17600
Block_size.size_x	Block x dimension	INT32	128, 8
Block_size.size_y	Block y dimension	INT32	512, 32

8.6.3 Per-block Metadata Description

Table 8-20: Per-block Metadata for Ocean Surface Product Files.

PerBlockMetadataCommon	Definition	Data Type	Valid Values
Block_number	Current block number	INT32	1-180

PerBlockMetadataCommon	Definition	Data Type	Valid Values
Ocean_flag	Flag signalling whether the block contains entirely ocean radiances	INT8	0 = block has no ocean or is a mix of ocean and land 1 = block is entirely ocean
Block_coor_ulc_som_meter.x	Upper left corner SOM block x coordinate in meters	FLOAT64	
Block_coor_ulc_som_meter.y	Upper left corner SOM block y coordinate in meters	FLOAT64	
Block_coor_lrc_som_meter.x	Lower right corner SOM block x coordinate in meters	FLOAT64	
Block_coor_lrc_som_meter.y	Lower right corner SOM block y coordinate in meters	FLOAT64	
Data_flag	Flag signalling whether the block contains entirely fill data	INT8	0 = block contains entirely fill data 1 = block contains valid data

Common Per Block Metadata	Definition	Data Type	Valid Values
Geometric DQI	Geometric Data Quality Indicator copied from the L1B2 Terrain-projected parameter file.	FLOAT64	-1 to 1

8.6.4 Per-line Metadata Description

None.

8.6.5 Per-pixel Metadata Description

None.

8.6.6 Grid Data Set Descriptions

In order to minimize storage for the Aerosol/Surface Product, some parameters will be packed so that each bit represents a logical value, or some number of bits within a byte or word represent a flag value. To facilitate the interpretation of scientific data, floating point values are not scaled. Floating point values and integer values may take on a flag value indicating invalid data. Currently, there is a flag value of -9999.0, representing missing floating point data; a flag value of 253, representing missing data for unsigned 8-bit integers; a flag value of 65533, representing missing data

for unsigned 16-bit integers; and a flag value of -32768, representing missing data for 16-bit signed integers. In addition, there are flag values representing underflow and overflow. There is a flag value of 254, representing underflow for unsigned 8-bit integers; a flag value of 255, representing overflow for unsigned 8-bit integers; a flag value of 65534, representing underflow for unsigned 16-bit integers; a flag value of 65535, representing overflow for unsigned 16-bit integers; a flag value of -32767, representing underflow for 16-bit signed integers; and a flag value of 32767, representing overflow for 16-bit signed integers. Note that we may later add more flag values to distinguish other reasons that the data are missing (e.g. never computed, arithmetic error, etc.).

Table 8-21: Ocean Surface Product Field Dimension Descriptions.

Dimension	Description	Valid Values
SOMBlockDim	<i>SOMBlockDim</i> is the number of SOM blocks in the file. The slowest-varying dimension is implicitly the SOM block dimension. It is not shown in the tables below.	- for the Aerosol and Land Surface files this can vary, with a typical value being approximately 140 - for the Ocean Surface file this will be 6
XDim	<i>XDim</i> is the number of lines in a block. The x dimension direction is identical to the standard SOM x dimension.	128 for 1.1 km parameters or 8 for 17.6 km parameters
YDim	<i>YDim</i> is the number of samples in a block. The y dimension direction is identical to the standard SOM y dimension.	512 for 1.1 km parameters or 32 for 17.6 km parameters
NTOACModelldDim	<i>NTOACModelldDim</i> is the number of TOAC model identifiers.	2

Table 8-22: Ocean Surface Product Grid Dataset Descriptions.

Field Name Parameter Description	Dimension List	Number Type	Units	Transformation	Flag Values
Grid SubregParamsOcn (Spatial Resolution: 1.1 km x 1.1 km, XDim = 128, YDim = 512)					
WaterLeavEqReflConv Water-leaving equivalent reflectance (conventional)	XDim, YDim	FLOAT32	n/a	n/a	-9999 = fill
WaterLeavEqReflExp Water-leaving equivalent reflectance (experimental)	XDim, YDim	FLOAT32	n/a	n/a	-9999 = fill
WaterLeavEqReflUnc Uncertainty in water-leaving equivalent reflectance (experimental)	XDim, YDim	FLOAT32	n/a	n/a	-9999 = fill

Field Name Parameter Description	Dimension List	Number Type	Units	Transformation	Flag Values
TOACAerModelId TOAC model identifiers (2)	XDim, YDim, NTOACModelIdDim	UINT8	n/a	n/a	253 = fill
TOACAerOptDepth 865 nm aerosol optical depth	XDim, YDim	FLOAT32	n/a	n/a	-9999 = fill
PhytoPigmConcConv Phytoplankton pigment concentration (conventional)	XDim, YDim	FLOAT32	mg m ⁻³	n/a	-9999 = fill
PhytoPigmConcExp Phytoplankton pigment concentration (experimental)	XDim, YDim	FLOAT32	mg m ⁻³	n/a	-9999 = fill
PhytoPigmConcUnc Uncertainty in phytoplankton pigment concentration (experimental)	XDim, YDim	FLOAT32	mg m ⁻³	n/a	-9999 = fill
DkWaterFlag Dark water flag	XDim, YDim	UINT8	n/a	n/a	0 = Is not a dark water region 1 = Is a dark water region 0 = fill
Grid RegParamsOcn (Spatial Resolution: 17.6 km x 17.6 km, XDim = 8, YDim = 32)					
GlitterWhiteEqReflAvg Average value of glitter + whitecap equivalent reflectance	XDim, YDim	FLOAT32	n/a	n/a	-9999 = fill
OceanColorCam Camera used in ocean color retrieval	XDim, YDim	UINT8	n/a	n/a	253 = fill

8.6.7 Per-grid QA Metadata

Table 8-23: Per-grid QA Metadata for Ocean Surface Products.

Data Field Name	Data Type	Field Dimension	Valid Range
Swath-level Constructs			
NRegWAnyGoodOcnSub	INT32	--	0-36,352
Block-level Constructs			

Data Field Name	Data Type	Field Dimension	Valid Range
BlockNumber Block number.	INT32	--	1-180
ValidRecord Indicates if valid data are present for the block.	UINT8	--	0,1
NRegWAnyGoodOcnSub Number of regions containing at least one good (non-fill) ocean subregion.	INT32	--	0-256
NSubWGoodOcnData Number of subregions containing good (non-fill) ocean data.	INT32	--	0-65,536
NSubOceanAlgProc Number of subregions processed with the ocean surface algorithms.	INT32	--	0-65,536
NSubSuccOcnAlgConv Number of subregions with a successful ocean retrieval using the conventional algorithm.	INT32	--	0-65,536
NSubSuccOcnAlgExp Number of subregions with a successful ocean retrieval using the experimental algorithm.	INT32	--	0-65,536
NRegOceanAlgProc Number of regions processed with the ocean surface algorithms.	INT32	--	0-256
GeomDataQualInd Geometric calibration data quality indicator.	FLOAT64	--	-1 to 1



9.0 MISR ANCILLARY PRODUCTS

9.1 MISR ANCILLARY PRODUCT GRANULE NAMES

MISR Ancillary Products are composed of the eight granules listed below (Table 9-1).

Table 9-1: MISR Ancillary File Granule Names.

MISR ANCILLARY FILE GRANULE NAME	ESDT Name	Section
MISR_AM1_AGP_Pmmm_vv.hdf	MIANCAGP	9.4
MISR_AM1_ARP_PRFLTCHAR_Fmm_vvv.hdf	MIANCARP	9.5
MISR_AM1_ARP_PRFLTCAL_Fmm_vvv.hdf	MIANCARP	9.6
MISR_AM1_ARP_INFLTCAL_Tmmm_Fmm_vvv.hdf	MIANCARP	9.7
MISR_AM1_ARP_CONFIG_Fmm_vvv.hdf	MIANCARP	9.8
MISR_AM1_ACP_APOP_Fmm_vvvv.hdf	MIANCACP	9.9
MISR_AM1_ACP_MIXTURE_Fmm_vvvv.hdf	MIANCACP	9.10
MISR_AM1_ACP_CLIMLIKE_Fmm_vvvv.hdf	MIANCACP	9.11

9.2 MISR ANCILLARY PRODUCT GRANULE BRIEF DESCRIPTIONS

9.2.1 MISR Ancillary MIANCAGP Geographic Product

The Ancillary Geographic Product (AGP) is essentially a global database of geographic properties, tailored to the needs of the MISR mission. The AGP is utilized in the creation of all MISR Level 1B2 and Level 2 products throughout the mission and is required for the interpretation of those products.

The parameters in this product are reported in a Space-Oblique Mercator (SOM) map projection. The map resolution of the projection is 1.1 km; this defines the horizontal sampling for most of the parameters. The horizontal datum, or surface-basis, for the projection is the WGS84 ellipsoid. This map projection and surface-basis is identical to what will be used for all the Level 1B2 and Level 2 parameters.

The AGP consists of 233 files, corresponding to the 233 repeat orbits of the EOS AM-1 spacecraft. The length and width covered by the AGP needs to be large enough to contain the maximum overlap width of the swath seen by all nine MISR camera views. This width varies per latitude to a minimum near the poles and a maximum of 378 km near the equator. The length of the AGP covers the maximal starting and ending points of the MISR instrument mapping of the surface. Since a mapping swath runs from terminator to terminator for every orbit, the AGP must run from the termina-

tor of the summer solstice at the north end of the orbit and the terminator of the winter solstice at the south end.

9.2.2 MISR Ancillary MIANCARP Pre-Flight Characterization Product

The Ancillary Radiometric Product (ARP) contains coefficients and data variables which are used in the Level 1B1 and Level 2 processing. There are four files associated with this product: the pre-flight instrument characterization file, which is not expected to change much over time; the preflight calibration data file; the in-flight calibration data; and the configuration parameters.

This file contains preflight instrument characterization parameters, supplied for data user reference. Examples include the measured spectral response functions, and the instantaneous fields-of-view. These parameters are not used by the DAAC processes. It is unlikely that this file will be modified once delivered. The version number will, however, be tracked.

9.2.3 MISR Ancillary MIANCARP Pre-Flight Calibration Product

This file contains preflight calibration data. It is distinguished from the Pre-flight Instrument Characterization Data, in that these data are used as input to the DAAC processing. Parameters include spectral descriptors relevant to Level 1B1 and Level 2 standard products, and band weighted solar irradiances. Radiometric gain coefficients are not included in this file, as they are updated on-orbit. It is unlikely that this file will be modified once delivered. However, the version number will be tracked.

9.2.4 MISR Ancillary MIANCARP In-Flight Calibration Product

This file contains the in-flight calibration data. It is also used as input to the DAAC standard processing. It is distinguished from the Pre-flight Calibration Data, in that these instrument parameters are monitored on-orbit. At-launch values are initialized by the Pre-flight Calibration Data. Monthly updates to this file allow processing to continue with current performance metrics. Parameters include radiometric calibration coefficients, calibration uncertainties, signal-to-noise ratios, and detector data quality indicators. A version number will track file format changes; a date range revision number will indicate a revision has been made to the parameters, should this occur.

9.2.5 MISR Ancillary MIANCARP Configuration Product

This file contains threshold parameters and process control limits used in the DAAC processing. An example is the average digital number (DN) value of a line above which data integrity is reduced. These parameters will change only at the discretion of the Principal Investigator, Instrument Scientist, and Science Team. Such a change would reflect a relaxation or stricter tolerance of specific data anomalies. A version number will reflect any such changes.

9.2.6 MISR Ancillary MIANCACP APOP Product

The Aerosol Physical and Optical Properties (APOP) file is part of the Aerosol Climatology Product (ACP). This file contains the microphysical and scattering characteristics of pure aerosol models upon which the routine retrievals are based. The physical properties (size distribution, index of refraction, and tendency to adsorb water) are based upon current knowledge. The effective optical properties are calculated using Mie theory for spherical particles, and ellipsoid approximations/geometric optics for non-spherical cases, for a range of relative humidities. Size statistics and indices of refraction are calculated, and optical properties are reported for all MISR bands.

9.2.7 MISR Ancillary MIANCACP Aerosol Mixture Product

The Aerosol Mixture file is part of the Aerosol Climatology Product (ACP). This file defines the mixtures of pure aerosols that will be compared to MISR observations. The mixtures are defined for each of the retrieval pathways that may occur during aerosol retrievals for each region of the globe. These include dark water surface, optically thick atmosphere, and heterogeneous land surface.

9.2.8 MISR Ancillary MIANCACP Climatological Likelihood Product

The Aerosol Clim-Likely file is part of the Aerosol Climatology Product (ACP). This file contains climatological likelihood values for each candidate aerosol model.¹

9.3 MISR ANCILLARY PRODUCT GRANULE DATA SETS

9.3.1 MISR Ancillary MIANCAGP Geographic Product

The product will be produced as one ESDT, with 233 physical files, as described above. Each physical file is in the HDF-EOS Grid “stacked-block” format and each contains one or more HDF-EOS Grid datasets, corresponding to parameters at certain spatial resolutions. The grid datasets have the usual x and y dimensions, as well as a third dimension corresponding to the SOM block number. The x and y dimensions correspond to the the number of samples in the along-track and cross-track directions. The blocks that make up the Level 1B2 Georectified Radiance Product files and all of the Level 2 product files are a direct subset of the blocks that make up the Ancillary Geographic Product.

9.3.2 MISR Ancillary MIANCARP Pre-Flight Characterization Product

One HDF file and data set.

9.3.3 MISR Ancillary MIANCARP Pre-Flight Calibration Product

One HDF file and data set.

1. This file does not yet exist, and its format has not been defined.

9.3.4 MISR Ancillary MIANCARP In-Flight Calibration Product

One HDF file and data set.

9.3.5 MISR Ancillary MIANCARP Configuration Product

One HDF file and data set.

9.3.6 MISR Ancillary MIANCACP APOP Product

One HDF file and data set.

9.3.7 MISR Ancillary MIANCACP MIXTURE Product

One HDF file and data set.

9.3.8 MISR Ancillary MIANCACP CLIMLIKE Product

TBD.

Table 9-2: Ancillary Product Files and Grid Datasets.

ESDT Shortname	Local Granule ID^a	Grid Dataset Name
MIANCAGP	MISR_AM1_AGP_Pnnn_Fmm_vv.hdf	Standard
		Regional
MIANCARP	MISR_AM1_ARP_PRFLTCHAR_Fmm_vvv.hdf	N/A
MIANCARP	MISR_AM1_ARP_PRFLTCAL_Fmm_vvv.hdf	N/A
MIANCARP	MISR_AM1_ARP_INFLTCAL_Tmmm_Fmm_vvv.hdf	N/A
MIANCARP	MISR_AM1_ARP_CONFIG_Fmm_vvv.hdf	N/A
MIANCACP	MISR_AM1_ACP_APOP_Fmm_vvvv.hdf	N/A
MIANCACP	MISR_AM1_ACP_MIXTURE_Fmm_vvvv.hdf	N/A
MIANCACP	MISR_AM1_ACP_CLIMLIKE_Fmm_vvvv.hdf	N/A

a. Pnnn corresponds to the orbit path, Fmm corresponds to the file format version number, and vv[vv] is the file version number.

9.4 MISR ANCILLARY MIANCAGP GEOGRAPHIC PRODUCT

9.4.1 File Metadata Description

Table 9-3: File Metadata for Ancillary Geographic Product Files.

File Metadata Field Name	Definition	Data Type	Units	Valid Range/ Value
Path_number	Orbit path number	INT32	N/A	1-233
AGP_version_id	Version Identifier for Ancillary Geographic Product	INT32	N/A	2
DID_version_id	Version Identifier for DID (DTED [Digital Terrain Elevation Dataset] Intermediate Dataset)	INT32	N/A	4
Number_blocks	Total number of blocks	INT32	N/A	1-180
Ocean_blocks_size	Ocean_blocks.number dimension	INT32	N/A	1-180
Ocean_blocks.count	Total number of blocks containing entirely ocean radiances	INT32	N/A	1-180
Ocean_blocks.numbers	List of block numbers containing entirely ocean radiances	INT32	N/A	1-180
SOM_parameters.som_ellipsoid.a	Semimajor axis of ellipsoid	FLOAT64	meters	WGS84
SOM_parameters.som_ellipsoid.e2	Eccentricity of ellipsoid squared	FLOAT64	N/A	WGS84
SOM_parameters.som_orbit.aprime	Semimajor axis of orbit	FLOAT64	meters	Not Used
SOM_parameters.som_orbit.eprime	Eccentricity of orbit	FLOAT64	N/A	Not Used
SOM_parameters.som_orbit.gama	Longitude of perigee	FLOAT64	radians	Not Used
SOM_parameters.som_orbit.nrev	Number of revolutions	INT32	N/A	233
SOM_parameters.som_orbit.ro	Radius of circular orbit	FLOAT64	meters	7078040.8
SOM_parameters.som_orbit.i	Inclination of orbit	FLOAT64	radians	1.7157253
SOM_parameters.som_orbit.P2P1	Ratio of time of revolution over length of Earth rotation/orbit	FLOAT64	N/A	0.0068666667

File Metadata Field Name	Definition	Data Type	Units	Valid Range/ Value
SOM_parameters.som_orbit.lambda0	Geodetic longitude of ascending node at time 0	FLOAT64	radians	0 - 2Pi
Origin_block.ulc.x	SOM X coordinate (in meters) of the upper left corner of the first block	FLOAT64	meters	6 million to 33 million
Origin_block.ulc.y	SOM Y coordinate (in meters) of the upper left corner of the first block	FLOAT64	meters	+/- 12 million
Origin_block.lrc.x	SOM X coordinate (in meters) of the lower right corner of the first block	FLOAT64	meters	6 million to 33 million
Origin_block.lrc.y	SOM Y coordinate (in meters) of the lower right corner of the first block	FLOAT64	meters	+/- 12 million
Start_block	The block number in the AGP which corresponds to the first block in this file containing data.	INT32	N/A	1 - 180 Start_block < End block
End_block	The block number in the AGP which corresponds to the last block in this file containing data.	INT32	N/A	1 - 180 Start_block < End block

9.4.2 Per-grid Metadata Description

Table 9-4: Per-grid Metadata for Ancillary Geographic Product Files.

Common Grid Metadata	Definition	Data Type	Valid Values
Block_size.resolution_x	Resolution of block x dimension in meters	INT32	1100
Block_size.resolution_y	Resolution of block y dimension in meters	INT32	1100
Block_size.size_x	Block x dimension	INT32	128
Block_size.size_y	Block y dimension	INT32	512

9.4.3 Per-block Metadata Description

Table 9-5: Per-block Metadata for Ancillary Geographic Product Files.

PerBlockMetadataCommon	Definition	Data Type	Valid Range
Block_number	Block number	INT32	1-180

PerBlockMetadataCommon	Definition	Data Type	Valid Range
Ocean_flag	Flag signalling whether the block contains entirely ocean radiances	INT8	0 = block has no ocean or is a mix of ocean and land 1 = block is entirely ocean
Block_coor_ulc_som_meter.x	Upper left corner SOM block x coordinate in meters	FLOAT64	
Block_coor_ulc_som_meter.y	Upper left corner SOM block y coordinate in meters	FLOAT64	
Block_coor_lrc_som_meter.x	Lower right corner SOM block x coordinate in meters	FLOAT64	
Block_coor_lrc_som_meter.y	Lower right corner SOM block y coordinate in meters	FLOAT64	
Data_flag	TBD	INT8	1 = Contains Data 0 = Not Valid

PerBlockMetadataAGP	Definition	Data Type	Valid Range
Point_elev_offset.x	X coordinate offset to point elevation location in meters	FLOAT64	
Point_elev_offset.y	Y coordinate offset to point elevation location in meters	FLOAT64	
ULC_latitude	Upper left corner latitude in degrees	FLOAT64	
ULC_longitude	Upper left corner longitude in degrees	FLOAT64	
ULC_som_meter.x	Upper left corner SOM block x coordinate in meters	FLOAT64	
ULC_som_meter.y	Upper left corner SOM block y coordinate in meters	FLOAT64	



PerBlockMetadataAGP	Definition	Data Type	Valid Range
ULC_som_pixel.x	Lower right corner SOM block x coordinate in meters	INT32	
ULC_som_pixel.y	Lower right corner SOM block y coordinate in meters	INT32	
Ave_block_elev	Average elevation for entire block	FLOAT64	

9.4.4 Grid Data Set Descriptions

Table 9-6: Ancillary Geographic Product Field Dimension Descriptions.

Dimension	Description	Valid Values
SOMBlockDim	<i>SOMBlockDim</i> is the number of SOM blocks in the file. The slowest-varying dimension is implicitly the SOM block dimension. It is not shown in the tables below.	180
XDim	<i>XDim</i> is the number of lines in a block. The x dimension direction is identical to the standard SOM x dimension.	128 for 1.1 km parameters 8 for 17.6 km parameters
YDim	<i>YDim</i> is the number of samples in a block. The y dimension direction is identical to the standard SOM y dimension.	512 for 1.1 km parameters 32 for 17.6 km parameters

Table 9-7: Ancillary Geographic Product Grid Dataset Descriptions.

Field Name Parameter Description	Dimension List	Number Type	Units	Flag Values or Valid Range
Grid Standard (Spatial Resolution: 1.1 km x 1.1 km, XDim = 128, YDim = 512)				
AveSceneElev Average Scene Elevation	XDim, YDim	INT16	meters	
StdDevSceneElev Standard Deviation of Scene Elevation	XDim, YDim	INT16	meters	
StdDevSceneElevRelSlp Standard Deviation of Scene Elevation Relative to Mean Slope	XDim, YDim	UINT16	n/a	
PtElev Point Elevation	XDim, YDim	INT16	meters	

Field Name Parameter Description	Dimension List	Number Type	Units	Flag Values or Valid Range
GeoLatitude Geographic Latitude	XDim, YDim	FLOAT32	degrees	
GeoLongitude Geographic Longitude	XDim, YDim	FLOAT32	degrees	
SurfaceFeatureID Surface Feature Identifiers	XDim, YDim	UINT8	n/a	0 = Ocean 1 = Land 2 = Coastline 3 = Inland Water 4 = Ephemeral Water 5 = Deep Inland Water 6 = Deep Ocean
AveSurfNormAzAng Average Surface-Normal Azimuth Angle	XDim, YDim	UINT8	degrees	
AveSurfNormZenAng Average Surface-Normal Zenith Angle	XDim, YDim	UINT8	degrees	
Grid Regional (Spatial Resolution: 17.6 km x 17.6 km, XDim = 6, YDim = 32)				
RegAveSceneElev Regional Average Scene Elevation	XDim, YDim	INT16	meters	
StdDevRegSceneElev Standard Deviation of Regional Average Scene Elevation	XDim, YDim	UINT16	meters	

9.5 MISR ANCILLARY MIANCARP PRFLTCHAR PRODUCT

9.5.1 File Metadata Description

Table 9-8: File Metadata for Ancillary Radiometric Pre-Flight Char Product Files.

Name	Type	Description
TITLE	8-bit signed char	Name of the ARP file
DATE	8-bit signed char	Date the file was written

9.5.2 Per-SDS Metadata Description

None.

9.5.3 Per-block Metadata Description

None.

9.5.4 Scientific Data Set Descriptions

The ARP data for each file are all in one Science Data Set (SDS). The global attributes hold all of the metadata. Each element in the SDS follows.

The ARP coefficients are placed into the HDF file in an averaging mode (subscript am), radiometric level (l), camera (c), band (b), and pixel (p) order. The index order is:

- averaging mode: 1x1, 1x4, 2x2, and 4x4;
- radiometric levels: from low to high values (0.001 to 1.0);
- camera order is: Df, Cf, Bf, Af, An, Aa, Ba, Ca, and Da;
- band order: Blue, Green, Red, NIR;
- pixel order is to be from 1 to 1504 for the forward cameras, and from 1504 to 1 for the nadir and aftward-viewing cameras, where this pixel index refers to the original camera clocking output order.

Parameters marked in column R have pixel order reversed for the forward cameras, as compared to



the CCD read-out order. In all instances, the Column dimension equals 1.

Table 9-9: ARP: Preflight characterization data.

Parameter name [units]	Dimension List	No. of values	Field name
Version number	Version	1	version_no
Spectral response profiles:			
$R_{\lambda}(c,b,s,\lambda)$ [none], measured response profiles	Camera Band Pixel Wavelength	9x4x3x 1471	meas_resp
$Z_R(c,b,s)$ [none], measured response profile zones	Camera Band Pixel	9x4x3	meas_resp_zone
$S_{\lambda}(b,\lambda)$ [none], standardized response profiles	Band Wavelength	4x1471	std_total_resp
$S_{\lambda}^{\text{in-band}}(b,\lambda)$ [none], in-band standardized response profiles	Band Inband Wavelength	4x200	std_inband_resp
in-band wavelength limits: $\lambda_l^{\text{std}}(b)$ [nm], lower limit, and $\lambda_u^{\text{std}}(b)$ [nm], upper limit	Band Column Band Column	λ_l^{std} : 4 λ_u^{std} : 4	wave_low_limit wave_high_limit
Gaussian analysis parameters, unweighted:			
$S_g^{\text{in-band}}(b)$ [none], peak response, gaussian fit to the standardized profile	Band Column	4	gauss_inband_peak
$\lambda_g^{\text{std,in-band}}(b)$ [nm], center wavelength, gaussian fit to the standardized profile	Band Column	4	gauss_inband_center_wav
$\Delta\lambda_g^{\text{std,in-band}}(b)$ [nm], bandwidth, gaussian fit to the standardized profile	Band Column	4	gauss_inband_bandwidth
$R_g^{\text{in-band}}(c,b,p)$ [none], peak response, gaussian fit to the measured profile	Camera Band Active pixels	9x4x 1504	meas_inband_peak
$\lambda_g^{\text{meas,in-band}}(c,b,p)$ [nm], center wavelength, gaussian fit to the measured profile	Camera Band Active pixels	9x4x 1504	meas_inband_center_wav

Table 9-9: ARP: Preflight characterization data.

Parameter name [units]	Dimension List	No. of values	Field name
$\Delta\lambda_g^{\text{meas, in-band}}(c,b,p)$ [nm], bandwidth, gaussian fit to the measured profile	Camera Band Active pixels	9x4x 1504	meas_inband_bandwidth
Moments analysis parameters, unweighted:			
$S_m^{\text{std}}(b)$ [none], equivalent response, moments analysis of the standardized profile	Band Column	4	std_moments_height
$\lambda_m^{\text{std}}(b)$ [nm], center wavelength, moments analysis of the standardized profile	Band Column	4	std_moments_center_wav
$\Delta\lambda_m^{\text{std}}(b)$ [nm], bandwidth, moments analysis of the standardized profile	Band Column	4	std_moments_width
$R_m(c,b,p)$ [none], equivalent response, moments analysis of the measured profile	Camera Band Active pixels	9x4x 1504	meas_moments_height
$\lambda_m^{\text{meas}}(c,b,p)$ [nm], center wavelength, moments analysis of the measured profile	Camera Band Active pixels	9x4x 1504	meas_moments_center_wav
$\Delta\lambda_m^{\text{meas}}(c,b,p)$ [nm], bandwidth, moments analysis of the measured profile	Camera Band Active pixels	9x4x 1504	meas_moments_width
Exo-atmospheric solar irradiance:			
$E_{0\lambda}(\lambda)$ [$\text{W m}^{-2} \mu\text{m}^{-1}$], exo-atmospheric solar irradiance	Wavelength Column	1471	exo_atm_irrad
Solar and measured response weighted parameters:			
$E_0^{\text{meas}}(c,b,p)$ [$\text{W m}^{-2} \mu\text{m}^{-1}$], solar irradiances, measured response weighted	Camera Band Active pixels	9x4x 1504	meas_solar_wgtd_height
$\lambda_{m,\text{solar}}^{\text{meas}}(c,b,p)$ [nm], center wavelength, solar and measured response weighted	Camera Band Active pixels	9x4x 1504	meas_solar_wgtd_center_wav

Table 9-9: ARP: Preflight characterization data.

Parameter name [units]	Dimension List	No. of values	Field name
$\Delta\lambda_{m,solar}^{meas}(c,b,p)$ [nm], bandwidth, solar and measured response weighted	Camera Band Active pixels	9x4x 1504	meas_solar_wgted_width
Instantaneous fields-of-view:			
$IFOV_x(c,b,s)$ [μ rad], crosstrack instantaneous fields-of-view	Camera Band Zone Pixel	9x4x5	ifov_crosstrk
$IFOV_d(c,b,s)$ [μ rad], downtrack fields-of-view	Camera Band Zone Pixel	9x4x5	ifov_downtrk
$Z_{ifov}(c,b,s)$ [none], measured IFOV zones	Camera Band Zone Pixel	9x4x5	ifov_zone
Effective focal length:			
EFL(c) [mm], effective focal length	Camera Column	9	efl



9.6 MISR ANCILLARY MIANCARP PRFLTAL PRODUCT

9.6.1 File Metadata Description

Table 9-10: File Metadata for Ancillary Radiometric PRFLTAL Product Files.

Name	Type	Description
TITLE	8-bit signed char	Name of the ARP file
DATE	8-bit signed char	Date the file was written

9.6.2 Per-SDS Metadata Description

None.

9.6.3 Per-block Metadata Description

None.

9.6.4 Scientific Data Set Descriptions

The ARP data for each file are all in one Science Data Set (SDS). The global attributes hold all of the metadata. Each element in the SDS follows.

The ARP coefficients are placed into the HDF file in an averaging mode (subscript am), radiometric level (l), camera (c), band (b), and pixel (p) order. The index order is:

- averaging mode: 1x1, 1x4, 2x2, and 4x4;
- radiometric levels: from low to high values (0.001 to 1.0);
- camera order is: Df, Cf, Bf, Af, An, Aa, Ba, Ca, and Da;
- band order: Blue, Green, Red, NIR;
- pixel order is to be from 1 to 1504 for the forward cameras, and from 1504 to 1 for the nadir and aftward-viewing cameras, where this pixel index refers to the original camera clocking output order.

Parameter [units]	Dimension List	No. of values	ARP software name
Version number	Version	1	pcd_version_no
Solar and in-band standardized response weighted parameters:			



Parameter [units]	Dimension List	No. of values	ARP software name
$E_0^{std,in-band(b)}$ [$W m^{-2} \mu m^{-1}$], solar irradiances, in-band standardized response weighted	Band Column	4	std_inband_solar_wgted_height
$\lambda_{m,solar}^{std,in-band(b)}$ [nm], center wavelength, solar and in-band standardized response weighted	Band Column	4	std_inband_solar_wgted_center_wav
$\Delta\lambda_{m,solar}^{std,in-band(b)}$ [nm], bandwidth, solar and in-band standardized response weighted	Band Column	4	std_inband_solar_wgted_width
Solar and total-band standardized response weighted parameters:			
$E_0^{std(b)}$ [$W m^{-2} \mu m^{-1}$], solar irradiances, standardized response weighted	Band Column	4	std_solar_wgted_height
$\lambda_{m,solar}^{std(b)}$ [nm], center wavelength, solar and standardized response weighted	Band Column	4	std_solar_wgted_center_wav
$\Delta\lambda_{m,solar}^{std(b)}$ [nm], bandwidth, solar and standardized response weighted	Band Column	4	std_solar_wgted_width
c(b,s) [none], Spectral out-of-band correction matrix	Band Index	4x4	spectral_corr_matrix

Parameter [units]	Dimension List	No. of values	ARP software name
PSF _{am(c,b,s)} [none], PSF functions	Camera Band Sample Camera Band 2x2 Sample Camera Band 4x4 Sample	PSF _{1x1} : 9x4x51 PSF _{2x2} : 9x4x25 PSF _{4x4} : 9x4x13	psf1x1 psf2x2 psf4x4
PAR(b) [none], PAR integration weights	PAR Band Column	3	par_int_wght

9.7 MISR ANCILLARY MIANCARP INFLTCAL PRODUCT

9.7.1 File Metadata Description

Table 9-11: File Metadata for Ancillary Radiometric INFLTCAL Product Files.

Name	Type	Description
TITLE	8-bit signed char	Name of the ARP file
DATE	8-bit signed char	Date the file was written

9.7.2 Per-SDS Metadata Description

None.

9.7.3 Per-block Metadata Description

None.

9.7.4 Scientific Data Set Descriptions

The ARP data for each file are all in one Science Data Set (SDS). The global attributes hold all of the metadata. Each element in the SDS follows.

The ARP coefficients are placed into the HDF file in an averaging mode (subscript am), radiometric level (l), camera (c), band (b), and pixel (p) order. The index order is:

- averaging mode: 1x1, 1x4, 2x2, and 4x4;
- radiometric levels: from low to high values (0.001 to 1.0);
- camera order is: Df, Cf, Bf, Af, An, Aa, Ba, Ca, and Da;
- band order: Blue, Green, Red, NIR;
- pixel order is to be from 1 to 1504 for the forward cameras, and from 1504 to 1 for the nadir and aftward-viewing cameras, where this pixel index refers to the original camera clocking output order.

Parameters marked in column R have pixel order reversed for the forward cameras, as compared to

the CCD read-out order.

Table 9-12: ARP: In-flight calibration data.

Parameter [units]	Dimension List	No. of values	ARP software name	R
Version number	Version	1	ifcd_version_no	
Radiometric calibration coefficients:				
Date range [none]	Date range Column	3	date_range	
Radiometric gain coefficients: $G_{0,am}(c,b)$ [DN] gain offset; $G_{1,am}(c,b)$ [DN/ (W m ⁻² μm ⁻¹ sr ⁻¹)] gain; $G_{2,am}(c,b)$ [DN/ (W m ⁻² μm ⁻¹ sr ⁻¹) ²] gain second order coefficient	Camera Band Active pixel Coefficient Camera Band 2x2 Summed pixel Coefficient Camera Band 4x4 Summed pixel Coefficient	$G_{0,1x1}$: 9x4x1504 $G_{1,1x1}$: 9x4x1504 $G_{2,1x1}$: 9x4x1504 $G_{0,2x2}$: 9x4x752 $G_{1,2x2}$: 9x4x752 $G_{2,2x2}$: 9x4x752 $G_{0,4x4}$: 9x4x376 $G_{1,4x4}$: 9x4x376 $G_{2,4x4}$: 9x4x376	rad_gain_coeff_1x1 rad_gain_coeff_2x2 rad_gain_coeff_4x4	
$t_{integ}(c,b)$ [msec], integration time	Camera Band	9x4	integration_time	
Calibration uncertainties:				
ER(l) [none], equivalent reflectances	Radiometric level Column	15	equiv_reflect	
$\epsilon_{abs_sys}(l,c,b)$ [%], absolute radiometric uncertainty: systematic component	Camera Band Radiometric level	9x4x15	abs_rad_unc_sys	
$\epsilon_{abs}(l,c,b)$ [%], absolute radiometric uncertainty: total for 1x1	Camera Band Radiometric level	9x4x15	abs_rad_unc_total_1x1	

Table 9-12: ARP: In-flight calibration data.

Parameter [units]	Dimension List	No. of values	ARP software name	R
$\epsilon_{cam_sys}(l,c,b)$ [%], camera-to-camera relative radiometric uncertainty: systematic component	Camera Band Radiometric level	9x4x15	cam_to_cam_rel_unc_sys	
$\epsilon_{cam}(l,c,b)$ [%], camera-to-camera relative radiometric uncertainty: total for 1x1	Camera Band Radiometric level	9x4x15	cam_to_cam_rel_unc_total_1x1	
$\epsilon_{band_sys}(l,c,b)$ [%], band-to-band relative radiometric uncertainty: systematic component	Camera Band Radiometric level	9x4x15	band_to_band_rel_unc_sys	
$\epsilon_{band}(l,c,b)$ [%], band-to-band relative radiometric uncertainty: total for 1x1	Camera Band Radiometric level	9x4x15	band_to_band_rel_unc_total_1x1	
$\epsilon_{pix_sys}(l,c,b)$ [%], pixel-to-pixel relative radiometric uncertainty: systematic component	Camera Band Radiometric level	9x4x15	pixel_to_pixel_rel_unc_sys	
$\epsilon_{pix}(l,c,b)$ [%], pixel-to-pixel relative radiometric uncertainty: total for 1x1	Camera Band Radiometric level	9x4x15	pixel_to_pixel_rel_unc_total_1x1	
$SNR_{am}(l,c,b)$ [none], signal-to-noise ratios	Camera Band Radiometric level	SNR_{1x1} : 9x4x15 SNR_{1x4} : 9x4x15 SNR_{2x2} : 9x4x15 SNR_{4x4} : 9x4x15	snr_1x1 snr_1x4 snr_2x2 snr_4x4	
$DDQI_{am}(c,b,s)$ [none], Detector Data Quality Indicators	Camera Band Active pixel	$DDQI_{1x1}$ 9x4x1504 $DDQI_{2x2}$ 9x4x752 $DDQI_{4x4}$ 9x4x376	ddqi_1x1 ddqi_2x2 ddqi_4x4	
$F(c,b)$ [none], channel operability flag	Camera Band	9x4	chnl_op_flag	

9.8 MISR ANCILLARY MIANCARP CONFIG PRODUCT

9.8.1 File Metadata Description

Table 9-13: File Metadata for Ancillary Radiometric CONFIG Product Files.

Name	Type	Description
TITLE	8-bit signed char	Name of the ARP file
DATE	8-bit signed char	Date the file was written

9.8.2 Per-grid Metadata Description

None.

9.8.3 Per-block Metadata Description

None.

9.8.4 Scientific Data Set Descriptions

The ARP data for each file are all in one Science Data Set (SDS). The global attributes hold all of the metadata. Each element in the SDS follows.

The ARP coefficients are placed into the HDF file in an averaging mode (subscript am), radiometric level (l), camera (c), band (b), and pixel (p) order. The index order is:

- averaging mode: 1x1, 1x4, 2x2, and 4x4;
- radiometric levels: from low to high values (0.001 to 1.0);
- camera order is: Df, Cf, Bf, Af, An, Aa, Ba, Ca, and Da;
- band order: Blue, Green, Red, NIR;
- pixel order is to be from 1 to 1504 for the forward cameras, and from 1504 to 1 for the nadir and aftward-viewing cameras, where this pixel index refers to the original camera clocking output order.

Parameter [unit]	Dimension List	No. of values	ARP software name
$L_{\max(b)}$ [$W m^{-2} \mu m^{-1} sr^{-1}$], band weighted maximum radiance	Band Column	4	band_wgted_max_rad
$DN_{\text{pix_sat}(c,b)}$ [DN], pixel saturation threshold	Camera Band	9x4	pix_sat_thresh
$n_{\text{pix_sat}}$ [none], number of allowable saturated pixels	Number	1	num_sat_pix
Pixel saturation block limits: $n_{\text{am}(s)}$ [none], saturation block start and saturation block end.	Pixel block Pixel block Pixel block Pixel block Pixel block	$n_{1 \times 1}$: 2 $n_{2 \times 2}$: 2 $n_{4 \times 4}$: 2	pix_satblk_1x1_str pix_satblk_1x1_end pix_satblk_2x2_str pix_satblk_2x2_end pix_satblk_4x4_str pix_satblk_4x4_end
$a_{\text{pix_sat}(s)}$ [none], pixel saturation noise coefficients	Coefficient Column	2	pix_sat_noise_coeff
$\epsilon_{\text{pix_sat}(s)}$ [%], pixel saturation error thresholds	Threshold Column	2	pix_sat_error_thresh
$DN_{\text{line_sat}(c,b)}$ [DN], line average threshold	Camera Band	9x4	line_av_thresh
$\Delta DN_{\text{line_sat}(c,b)}$ [DN], line average noise	Camera Band	9x4	line_av_noise
$\epsilon_{\text{line_sat}(s)}$ [%], line average error thresholds	Threshold Column	2	line_av_error_thresh
Low DN threshold below which DN values would convert to negative radiances, and instead are set to zero	DN	1	DN_thresh
f, proportion of energy to subtract due to background	Camera Band	9x4	ghost_scalar
$\Delta \text{lines}_{1 \times 1}$, number of lines to average for background	Lines	1	downtrack_lines_1x1
$\Delta \text{lines}_{2 \times 2}$, number of lines to average for background	Lines	1	downtrack_lines_2x2

Parameter [unit]	Dimension List	No. of values	ARP software name
Δ lines _{4x4} , number of lines to average for background	Lines	1	downtrack_lines_4x4
Δ pixels _{1x1} , number of pixels to average for background	Pixels	1	crosstrack_pixels_1x1
Δ pixels _{2x2} , number of pixels to average for background	Pixels	1	crosstrack_pixels_2x2
Δ pixels _{4x4} , number of pixels to average for background	Pixels	1	crosstrack_pixels_4x4

9.9 MISR ANCILLARY MIANCACP APOP PRODUCT

9.9.1 File Metadata Description

The APOP global attributes are small pieces of information which provide information on the data contained in the file. Some of the information is redundant, in that it can be extracted from the data itself using native HDF function calls. This information is provided as an aid to human viewers of the data.

Table 9-14: Global Attributes

Attribute Name	Type	Value
Number of models	INT32	11
Number of input model types	INT32	11
Number of bands	INT32	4
Number of hydrated relative humidities	INT32	1
Number of scattering angles	INT32	205
Number of water activity models	INT32	1
Number of particle shape models	INT32	3
Reference relative humidity	FLOAT32	0.0



9.9.2 Per-grid Metadata Description

None.

9.9.3 Per-block Metadata Description

None.

9.9.4 Vdata Set Descriptions

HDF Vdatas are mixed data type structures which are dimensioned by records. Each record contains one or more fields, which may be of varying types. Character types are 1 byte long; float and integer types are 4 bytes long. Each field contains one or more pieces of information, all of the same type.

9.9.4.1 APOP Vdata fill values

Several Vdata fields are allowed to have fill values where there is no applicable valid value. These fields are the Log normal characteristic radius, Log normal characteristic width, and Power law exponent, in the Input Pure Particle Types Vdata and the Data Table Vdata. In all of these cases, the fill value is -999.0.

9.9.4.2 APOP Vdata parameters

The APOP file contains six Vdatas. The vdatas are summarized in the table below. Details of each vdata structure follow immediately after the summary.

Table 9-15: APOP Vdata Summary

Vdata name	Vdata class	Records	Description
Summary Table	Mixed data type	One per model	Contains information which allows users to determine quickly which models are contained in the dataset
Input Component Particle Types	Mixed data type	One per model type	Contains information used in creating the APOP
Data Table	Mixed data type	One per model	Contains the primary APOP data
Bands	Mixed data type	One per band	Contains a list specifying the wavelength and band number used for each band



Table 9-15: APOP Vdata Summary

Vdata name	Vdata class	Records	Description
Hydrated Relative Humidities	Floating point	One per relative humidity	Contains a list of the hydrated relative humidities
Scattering Angles	Floating point	One per scattering angle	Contains a list of the scattering angles used



9.9.4.2.1 Summary Table.

Table 9-16: Summary Table Fields

Field Name	Elements	Type
Aerosol model name	80	CHAR8
Model number	1	INT32
Relative humidity	1	FLOAT32

9.9.4.2.2 Input Component Particle Types.

Table 9-17: Input Component Particle Types Fields

Field Name	Units	Elements	Type
Input model number	None.	1	INT32
Aerosol model type	None.	80	CHAR8
Minimum radius	μm	1	FLOAT32
Maximum radius	μm	1	FLOAT32
Log normal characteristic radius	μm	1	FLOAT32
Log normal characteristic width	μm	1	FLOAT32
Power law exponent	None.	1	FLOAT32
Spectral refractive index real	None.	4	FLOAT32
Spectral refractive index imaginary	None.	4	FLOAT32
Particle density	g / cm^3	1	FLOAT32
Relative humidity	decimal fraction	1	FLOAT32
Hygroscopic	None.	80	CHAR8
Layer base height	km	1	FLOAT32
Layer top height	km	1	FLOAT32
Layer scale height	km	1	FLOAT32
Shape	None.	80	CHAR8
Water activity model	None.	80	CHAR8

9.9.4.2.3 Data Table

Table 9-18: Data Table Fields

Name	Units	Elements	Type
Aerosol model name	None.	80	CHAR8
Model number	None.	1	INT32
Input model number	None.	1	INT32
Reference relative humidity model number	None.	1	INT32
Water activity model	None.	80	CHAR8
Hygroscopic	None.	80	CHAR8
Shape	None.	80	CHAR8
Relative humidity	decimal fraction	1	FLOAT32
Size distribution	None.	80	CHAR8
Minimum radius	μm	1	FLOAT32
Maximum radius	μm	1	FLOAT32
Log normal characteristic radius	μm	1	FLOAT32
Log normal characteristic width	μm	1	FLOAT32
Power law exponent	None.	1	FLOAT32
Arithmetic mean radius	μm	1	FLOAT32
Weighted mean particle cross section	μm^2	1	FLOAT32
Weighted mean particle volume	μm^3	1	FLOAT32
Effective particle radius	μm	1	FLOAT32
Effective size variance	μm	1	FLOAT32
Volume weighted mean radius	μm	1	FLOAT32
Particle density	g / cm^3	1	FLOAT32
Layer base height	km	1	FLOAT32
Layer top height	km	1	FLOAT32
Layer scale height	km	1	FLOAT32
Spectral refractive index real	None.	4	FLOAT32
Spectral refractive index imaginary	None.	4	FLOAT32
Spectral scattering cross section	μm^2	4	FLOAT32
Spectral extinction cross section	μm^2	4	FLOAT32

Table 9-18: Data Table Fields (Continued)

Name	Units	Elements	Type
Spectral single scattering albedo	None.	4	FLOAT32
Spectral anisotropy parameter	None.	4	FLOAT32

9.9.4.2.4 Bands.

Table 9-19: Bands Fields

Field Name	Units	Elements	Type
Band number	None.	1	INT32
std_inband_solar_wgtd_center_wav	μm	1	FLOAT32

9.9.4.2.5 Hydrated Relative Humidities.

Table 9-20: Hydrated Relative Humidities Fields

Field Name	Units	Elements	Type
Relative humidity	decimal fraction	1	FLOAT32

9.9.4.2.6 Scattering Angles.

Table 9-21: Scattering Angles Fields

Field Name	Units	Elements	Type
Scattering angle	degrees	1	FLOAT32

9.9.5 Scientific Data Set Descriptions

HDF Scientific Data Sets (SDSs) are multi-dimensional arrays which utilize a single data type. The APOP uses an SDS to provide information on the phase functions of all models. Dimension

scales for the phase function information are also provided.

Table 9-22: APOP SDS Summary

SDS Name	Units	Dimensions	Type	Description
Spectral Phase Functions	sr ⁻¹	11 x 205 x 4	FLOAT32	Effective scattering phase function on a fixed grid of scattering angles
Model number	None.	11	INT32	Model number for each pure particle model. Used as a dimension scale for the Spectral Phase Functions SDS
Scattering angle	degrees	205	FLOAT32	Scattering angle grid. Used as a dimension scale for the Spectral Phase Functions SDS
Band	μm	4	FLOAT32	Wavelength for each band. Used as a dimension scale for the Spectral Phase Functions SDS

9.10 MISR ANCILLARY MIANCACP MIXTURE PRODUCT

9.10.1 File Metadata Description

The Mixture global attributes are small pieces of information which provide information on the data contained in the file. Some of the information is redundant, in that it can be extracted from the data itself using native HDF function calls. This information is provided as an aid to human viewers of the data.

Table 9-23: Global Attributes

Attribute Name	Type	Value
Number of mixtures	INT32	24
Maximum available number of components	INT32	3
Number of component models contained in APOP file	INT32	11
Number of bands	INT32	4
Number of algorithm types/retrieval paths	INT32	3
Reference relative humidity	FLOAT32	0.0
Reference band number	INT32	2
Reference band optical depth	FLOAT32	1.0

9.10.2 Per-grid Metadata Description

None.

9.10.3 Per-block Metadata Description

None.

9.10.4 Vdata Set Descriptions

HDF Vdatas are mixed data type structures which are dimensioned by records. Each record contains one or more fields, which may be of varying types. Character types are 1 byte long; float and integer types are 4 bytes long. Each field contains one or more pieces of information, all of the same type. The Mixture file contains five of these Vdatas, which are described below.

9.10.4.1 Mixture Vdata fill values

None.

9.10.4.2 Mixture Vdata parameters

The Mixture file contains five Vdatas. The vdatas are summarized in the table below. Details of each vdata structure follow immediately after the summary.

Table 9-24: APOP Vdata Summary

Vdata name	Vdata class	Records	Description
Mixture Data	Mixed data type	One per mixture	Contains the mixture data
Component Model Legend	Mixed data type	One per component model	Contains a list specifying the model number and model name of each component contained in the APOP file
Bands	Mixed data type	One per band	Contains a list specifying the wavelength and band number used for each band
Retrieval Path Indices	Integer	One	Contains a list specifying the index into the retrieval path applicability flag array for each algorithm type
Retrieval Path Applicability Flag Legend	Mixed data type	Two	Contains the meaning of each retrieval path applicability flag value



9.10.4.2.1 Mixture Data.

Table 9-25: Mixture Data Fields

Field Name	Units	Elements	Type
Aerosol mixture number	None.	1	INT32
Mixture type	None.	80	CHAR8
Relative humidity	decimal fraction	1	FLOAT32
Component model number	None.	3	INT32
Component fractional optical depth at reference rh and band	None.	3	FLOAT32
Normalized mixture spectral optical depth	None.	4	FLOAT32
Mixture spectral single scattering albedo	None.	4	FLOAT32
Retrieval path applicability flag	None.	3	INT32

9.10.4.2.2 Component Model Legend.

Table 9-26: Component Model Legends Fields

Field Name	Units	Elements	Type
Component model number	None.	1	INT32
Component model name	None.	80	CHAR8

9.10.4.2.3 Bands.

Table 9-27: Bands Fields

Field Name	Units	Elements	Type
Band number	None.	1	INT32
std_inband_solar_wgtd_center_wav	μm	1	FLOAT32

9.10.4.2.4 Retrieval Path Indices.

Table 9-28: Retrieval Path Indices Fields

Field Name	Elements	Type
Dark water index	1	INT32
Optically thick atmosphere index	1	INT32
Heterogeneous land index	1	INT32

9.10.4.2.5 Retrieval Path Applicability Flag Legend.

Table 9-29: Retrieval Path Applicability Flag Legend Fields

Field Name	Elements	Type
Retrieval path applicability flag value	1	INT32
Meaning of flag value	80	CHAR8

9.10.5 Scientific Data Set Descriptions

HDF Scientific Data Sets (SDSs) are multi-dimensional arrays which utilize a single data type. The Mixture file uses an SDS to provide information on the spectral optical depth fractions for each component. Dimension scale information is also provided.

Table 9-30: Mixture SDS Summary

SDS Name	Units	Dimensions	Type	Description
Component Fractional Spectral Optical Depth	None.	4 x 3 x 24	FLOAT32	Relative abundances (as fractions of total optical depth) of the 3 aerosol components, specified in each spectral band
Band	μm	4	FLOAT32	Wavelength for each band. Used as a dimension scale for the Component Fractional Spectral Optical Depth SDS

9.11 MISR ANCILLARY MIANCACP CLIM-LIKELY PRODUCT¹**9.11.1 File Metadata Description**

TBD.

9.11.2 Per-grid Metadata Description

TBD.

1. This file does not yet exist, and its format has not been defined.

9.11.3 Per-block Metadata Description

TBD.

9.11.4 Vdata Set Descriptions

TBD.

9.11.5 Scientific Data Set Descriptions

TBD.

10.0 MISR LEVEL 3 COMPONENT PRODUCTS

10.1 MISR LEVEL 3 PRODUCT GRANULE NAMES

MISR Level 3 Component Products are composed of three different kinds of file granules reported at 3 different time scales; monthly, seasonal, and yearly. The files have an identical format on each of the time scales. The file granules are listed below (Table 10-1).

Table 10-1: MISR Level 3 File Granule Names

MISR LEVEL 3 FILE GRANULE NAME ^a	ESDT Name	Section
MISR_AM1_CGGRP_mmm_yyyy_Fff_vvvv.hdf	MIL3MRD	§10.4
MISR_AM1_CGGRP_sss_yyyy_Fff_vvvv.hdf	MIL3QRD	§10.4
MISR_AM1_CGGRP_yyyy_Fff_vvvv.hdf	MIL3YRD	§10.4
MISR_AM1_CGAS_mmm_yyyy_Fff_vvvv.hdf	MIL3MAE	§10.5
MISR_AM1_CGAS_sss_yyyy_Fff_vvvv.hdf	MIL3QAE	§10.5
MISR_AM1_CGAS_yyyy_Fff_vvvv.hdf	MIL3YAE	§10.5
MISR_AM1_CGLS_mmm_yyyy_Fff_vvvv.hdf	MIL3MLS	§10.6
MISR_AM1_CGLS_sss_yyyy_Fff_vvvv.hdf	MIL3QLS	§10.6
MISR_AM1_CGLS_yyyy_Fff_vvvv.hdf	MIL3YLS	§10.6

a. “mmm” is the three character month (one of “JAN”, “FEB”, “MAR”, “APR”, “MAY”, “JUN”, “JUL”, “AUG”, “SEP”, “OCT”, “NOV”, “DEC”), “sss” is the season (one of “WIN”, “SPR”, “SUM”, “FALL”), “yyyy” is the four digit year (e.g., “2002”), “ff” is the format version number (e.g. “01”), and “vvvv” is the data version number (e.g., “0001”).

10.2 MISR LEVEL 3 PRODUCT GRANULE BRIEF DESCRIPTIONS

Level 3 provides a global summary of Level 1 and Level 2 data. Level 1 and 2 parameters of interest are averaged over a month, season, or year and the results reported on a geographic grid, with resolution 0.5 degree by 0.5 degrees. In addition, for some parameters the variance of that parameter and covariance with other parameters are also reported. To reduce the size of the Level 3 files, the variance/covariance is reported at a coarser resolution of 1 degree by 1 degree.

10.3 MISR LEVEL 3 PRODUCT GRANULE DATA SETS

The product will be produced as 9 separate ESDTs, each with one physical file (Table 10-2). There are 3 different kinds of files, each reported on 3 different time scales.

Each file contains one or more HDF-EOS grids. Each grid is in a geographic projection, with a resolution of either 0.5 degree by 0.5 degree or 1 degree by 1 degree.

Table 10-2: Level 3 Component Global Product Files and Grid Datasets

ESDT Short name	Local Granule ID ^a	Grid Dataset Name
MIL3MRD	MISR_AM1_CGGRP_mmm_yyyy_Fff_vvvv.hdf	GeorectifiedRadianceAverage
MIL3QRD	MISR_AM1_CGGRP_sss_yyyy_Fff_vvvv.hdf	GeorectifiedRadianceCovariance
MIL3YRD	MISR_AM1_CGGRP_yyyy_Fff_vvvv.hdf	
MIL3MAE	MISR_AM1_CGAS_mmm_yyyy_Fff_vvvv.hdf	AerosolParameterAverage
MIL3QAE	MISR_AM1_CGAS_sss_yyyy_Fff_vvvv.hdf	
MIL3YAE	MISR_AM1_CGAS_yyyy_Fff_vvvv.hdf	
MIL3MLS	MISR_AM1_CGLS_mmm_yyyy_Fff_vvvv.hdf	LandParameterAverage
MIL3QLS	MISR_AM1_CGLS_sss_yyyy_Fff_vvvv.hdf	
MIL3YLS	MISR_AM1_CGLS_yyyy_Fff_vvvv.hdf	

a. mmm” is the three character month (one of “JAN”, “FEB”, “MAR”, “APR”, “MAY”, “JUN”, “JUL”, “AUG”, “SEP”, “OCT”, “NOV”, “DEC”), “sss” is the season (one of “WIN”, “SPR”, “SUM”, “FALL”), “yyyy” is the four digit year (e.g., “2002”), “ff” is the format version number (e.g. “01”), and “vvvv” is the data version number (e.g., “0001”)

There is a standard set of HDF vdatas included in each of the files that contains metadata information. See for example Table 10-3. This includes:

1. There is a vdata “Source file” that contains a description of the swaths that are summarized in the Level 3 product. The vdata has four columns, “Orbit number”, “Path number”, “Local Granule Id”, and “Local version Id”. There is a row in the vdata for each swath that is summarized in the Level 3 product.
2. For each HDF dimension that appears in a HDF-EOS grid there is a vdata “<Dimension name> Enumeration” that contains a description of each value of the enumeration. For example, several of the file types contains grid indexed by a the dimension “Band”. There is a vdata “Band Enumeration” that contains 4 values “Blue (443 nm)”, “Green (555 nm)”, “Red (670 nm)”, and “Infrared (865 nm)”. This indicates that a Band dimension value of 0 is the blue band, a value of 1 is the green band, and so on.
3. For each field in an HDF-EOS grid, there is a vdata that summarizes overall statistics about the field, named “<Field name> Statistic”. For example, MIL3MLS contains a grid with a field “NDVI average”, so there is a vdata “NDVI average Statistic”. The vdata has 5 columns “Minimum”, “Maximum”, “Mean”, “Standard Deviation”, and “Count”. These vdata can be used by display packages to scale the data for display, among other uses.

10.4 MISR LEVEL 3 MIL3MRD, MIL3QRD, MIL3YRD COMPONENT GLOBAL GEORECTIFIED PRODUCT

10.4.1 File Metadata Description

Table 10-3: CGGRP File metadata

Vdata Name	Vdata Field Name	Definition	Data Type	Units	Valid Range
Source File	Orbit Number	List of orbits that are summarized in this Level 3 file.	INT32	NA	0-999999
	Path Number	List of paths that are summarized in this Level 3 file.	UINT8	NA	1-233
	Local Granule Id	List of local granule IDs summarized in this Level 3 file. Only the DF terrain file is listed, since the other input files follow from this example file.	CHAR8 x 80	NA	NA
	Local Version Id	List of local version IDs summarized in this Level 3 file. Only DF terrain is listed.	CHAR8 x 100	NA	NA
<Dimension name> Enumeration ^a	Value	Meaning of each value in the dimension. For example, Band has 4 entries: "Blue (443 nm)", "Green (555 nm)", "Red (670 nm)", "Infrared (865 nm)".	CHAR8 x 60	NA	NA
<Grid field name> Statistic ^b	Minimum	Minimum found in grid. This is taken over XDim and YDim. Other dimensions are collapsed into a 1D array ^c .	FLOAT32	Same as for grid	Same as for grid
	Maximum	Maximum found in grid	FLOAT32	Same as for grid	Same as for grid
	Mean	Mean of grid	FLOAT32	Same as for grid	Same as for grid
	Standard Deviation	Standard deviation of grid	FLOAT32	NA	>= 0
	Count	Count of grid	INT32	NA	>= 0

a. <Dimension name> is a place holder for each dimension in file. For example, there is one Vdata named "Band Enumeration", and another named "Camera Enumeration". See Table 10-4 for list of Dimensions.

b. <Grid field name> is a place holder for each grid field name in file. For example, there is one Vdata named "Average Statistic", and another named "Average count Statistic". See Table 10-5 for list of grid fields.

c. For example, for a grid field that is XDim x YDim x Camera x Band the average is reported as a Camera x Band flattened into a 1 D list of $9 \times 4 = 36$ values.

10.4.2 File Dimensions

Table 10-4: CGGRP File Dimensions

Dimension	Description	Number values	Values
Camera	MISR Camera	9	0 = Df, 1 = Cf, 2 = Bf, 3 = Af, 4 = An, 5 = Aa, 6 = Ba, 7 = Ca, 8 = Da
Band	MISR Camera Band	4	0 = Blue (443 nm), 1 = Green (555 nm), 2 = Red (670 nm), 3 = Infrared (865 nm)
CovarianceIndex	Index in covariance matrix	666	0 = Variance Df Blue (443 nm), 1 = Covariance Df Blue (443 nm), Df Green (555 nm) 2 = Variance Df Green (555 nm) ... This is all the lower triangle entries of the covariance matrix

10.4.3 Grid Dataset Description

Table 10-5: CGGRP Grid Dataset Description

Field Name Parameter Description	Dimensions List	Number Type	Units	Flag Values
GeorectifiedRadianceAverage (0.5 degree x 0.5 degree, XDim = 720, YDim = 360)				
Average fill flag This is an implementation detail, and not likely to be of interest to a user. ^a	XDim, YDim	INT8	NA	0 = all other fields fill 1 = other fields might not be fill
Average Average of radiances	Band, Camera, XDim, YDim	FLOAT32	W m ⁻² sr ⁻¹ μm ⁻¹	-9999 = fill

Table 10-5: CGGRP Grid Dataset Description

Field Name Parameter Description	Dimensions List	Number Type	Units	Flag Values
Average count Count of radiances used in average	Band, Camera, XDim, YDim	INT32	NA	NA
GeorectifiedRadianceCovariance (1 degree x 1 degree, XDim = 360, YDim = 180)				
Covariance fill flag This is an implementation detail, and not likely to be of interest to a user. ^b	XDim, YDim	INT8	NA	0 = all other fields fill 1 = other fields might not be fill
Covariance Variance and covariances between radiances. This contains only the lower triangle part of the symmetric covariance matrix.	CovarianceIndex, XDim, YDim	FLOAT32	$W^2 m^{-4} sr^{-2}$ μm^{-2}	0 = fill
Covariance average 1 Average of the first radiance in the covariance. ^c	CovarianceIndex, XDim, YDim	FLOAT32	$W m^{-2} sr^{-1}$ μm^{-1}	-9999 = fill
Covariance average 2 Average of the second radiance in the covariance. ^d	CovarianceIndex, XDim, YDim	FLOAT32	$W m^{-2} sr^{-1}$ μm^{-1}	-9999 = fill
Covariance count Count of radiance pairs that are used in covariance	CovarianceIndex, XDim, YDim	INT32	NA	NA

a. This is a flag field. If the value is 0, then all of the other fields in the GeorectifiedRadianceAverage grid will contain fill data for the grid cell location. However, even if the flag is 1 other fields might still contain fill data. This is used during processing to avoid looking at grid cells that are certain not to have data.

b. This is a flag field. If the value is 0, then all of the other fields in the GeorectifiedRadianceCovariance grid will contain fill data for the grid cell location. However, even if the flag is 1 other fields might still contain fill data. This is used during processing to avoid looking at grid cells that are certain not to have data.

c. This is almost the same as the information in the "Average" field except: 1) it is reported on 1 degree by 1 degree grid rather than 0.5 degree by 0.5 degree and 2) only radiances where both the first and second radiance in the covariance are available are include, e.g. if the this is for "Covariance Df Red, Cf Blue" only radiances where both the Df Red and Cf Blue are not fill are included.

d. Same comment here.

10.5 MISR LEVEL 3 MIL3MAE, MIL3QAE, MIL3YAE COMPONENT GLOBAL AEROSOL PRODUCT

10.5.1 File Metadata Description

Table 10-6: CGAS File metadata

Vdata Name	Vdata Field Name	Definition	Data Type	Units	Valid Range
Source File	Orbit Number	List of orbits that are summarized in this Level 3 file.	INT32	NA	0-999999
	Path Number	List of paths that are summarized in this Level 3 file.	UINT8	NA	1-233
	Local Granule Id	List of local granule IDs summarized in this Level 3 file.	CHAR8 x 80	NA	NA
	Local Version Id	List of local version IDs summarized in this Level 3 file.	CHAR8 x 100	NA	NA
<Dimension name> Enumeration ^a	Value	Meaning of each value in the dimension.	CHAR8 x 60	NA	NA
<Grid field name> Statistic ^b	Minimum	Minimum found in grid. This is taken over XDim and YDim. Other dimensions are collapsed into a 1D array ^c .	FLOAT32	Same as for grid	Same as for grid
	Maximum	Maximum found in grid	FLOAT32	Same as for grid	Same as for grid
	Mean	Mean of grid	FLOAT32	Same as for grid	Same as for grid
	Standard Deviation	Standard deviation of grid	FLOAT32	NA	>= 0
	Count	Count of grid	INT32	NA	>= 0

a. <Dimension name> is a place holder for each dimension in file. For example, there is one Vdata named "AlgorithmType Enumeration". See Table 10-7 for list of Dimensions.

b. <Grid field name> is a place holder for each grid field name in file. For example, there is one Vdata named "Optical depth average Statistic". See Table 10-8 for list of grid fields.

c. For example, for a grid field that is XDim x YDim x AlgorithmType the average is reported as a AlgorithmType flattened into a 1 D list of 8 values.

10.5.2 File Dimensions

Table 10-7: CGAS File Dimensions

Dimension	Description	Number values	Values
AlgorithmType	Algorithm type flag used by Level 2 processing to generate the Aerosol optical depth.	8	0 = No retrieval, 1 = Dark water retrieval, 2 =Optically thick atmosphere (OTA) retrieval, 3 = Heterogeneous land retrieval, 4 = No retrieval, using low optical depth algorithm, 5 = No retrieval, using optical depth in previous domain, 6 = No retrieval, using Rayleigh scattering only algorithm, 7 = No retrieval, using optical depth upper bound algorithm

10.5.3 Grid Dataset Description

Table 10-8: CGAS Grid Dataset Description

Field Name Parameter Description	Dimensions List	Number Type	Units	Flag Values
AerosolParameterAverage (0.5 degree x 0.5 degree, XDim = 720, YDim = 360)				
Algorithm type count Number of Level 2 grid cells that were processed with a particular algorithm.	AlgorithmType, XDim, YDim	INT32	NA	NA
Average fill flag This is an implementation detail, and not likely to be of interest to a user. ^a	XDim, YDim	INT8	NA	0 = all other fields fill 1 = other fields might not be fill
Optical depth average Average of optical depth. ^b	XDim, YDim	FLOAT32	NA	-9999 = fill
Optical depth average count Count of optical depths used in average.	XDim, YDim	INT32	NA	NA

- a. This is a flag field. If the value is 0, then all of the other fields in the GeorectifiedRadianceAverage grid will contain fill data for the grid cell location. However, even if the flag is 1 other fields might still contain fill data. This is used during processing to avoid looking at grid cells that are certain not to have data.
- b. There are several optical depths reported in Level 2. Level 3 uses the RegMeanSpectralOptDepth (see Table 8-9 on page 220). The Level 2 data has a value for each of the 4 MISR spectral bands, but Level 3 uses only the green band.

10.6 MISR LEVEL 3 MIL3MLS, MIL3QLS, MIL3YLS COMPONENT GLOBAL LAND/SURFACE PRODUCT



10.6.1 File Metadata Description

Table 10-9: CGLS File metadata

Vdata Name	Vdata Field Name	Definition	Data Type	Units	Valid Range
Source File	Orbit Number	List of orbits that are summarized in this Level 3 file	INT32	NA	0-999999
	Path Number	List of paths that are summarized in this Level 3 file	UINT8	NA	1-233
	Local Granule Id	List of local granule IDs summarized in this Level 3 file.	CHAR8 x 80	NA	NA
	Local Version Id	List of local version IDs summarized in this Level 3 file.	CHAR8 x 100	NA	NA
<Dimension name> Enumeration ^a	Value	Meaning of each value in the dimension. For example, Band has 4 entries: "Blue (443 nm)", "Green (555 nm)", "Red (670 nm)", "Infrared (865 nm)"	CHAR8 x 60	NA	NA
<Grid field name> Statistic ^b	Minimum	Minimum found in grid. This is taken over XDim and YDim. Other dimensions are collapsed into a 1D array ^c .	FLOAT32	Same as for grid	Same as for grid
	Maximum	Maximum found in grid	FLOAT32	Same as for grid	Same as for grid
	Mean	Mean of grid	FLOAT32	Same as for grid	Same as for grid
	Standard Deviation	Standard deviation of grid	FLOAT32	NA	>= 0
	Count	Count of grid	INT32	NA	>= 0

a. <Dimension name> is a place holder for each dimension in file. For example, there is one Vdata named "Band Enumeration", and another named "Camera Enumeration". See Table 10-10 for list of Dimensions.

b. <Grid field name> is a place holder for each grid field name in file. For example, there is one Vdata named "DHR average Statistic", and another named "DHR average count Statistic". See Table 10-11 for list of grid fields.

c. For example, for a grid field that is XDim x YDim x Camera x Band the average is reported as a Camera x Band flattened into a 1 D list of $9 \times 4 = 36$ values.

10.6.2 File Dimensions

Table 10-10: CGLS File Dimensions

Dimension	Description	Number values	Values
Band	MISR Camera Band	4	0 = Blue (443 nm), 1 = Green (555 nm), 2 = Red (670 nm), 3 = Infrared (865 nm)

10.6.3 Grid Dataset Description

Table 10-11: CGLS Grid Dataset Description

Field Name Parameter Description	Dimensions List	Number Type	Units	Flag Values
LandParameterAverage (0.5 degree x 0.5 degree, XDim = 720, YDim = 360)				
Average fill flag This is an implementation detail, and not likely to be of interest to a user. ^a	XDim, YDim	INT8	NA	0 = all other fields fill 1 = other fields might not be fill
DHR average Average of DHR (Directional-Hemispheric Reflectance). Defined as radiant exitance divided by irradiance under illumination from a single direction. Also known as the "black sky" albedo.	Band, XDim, YDim	FLOAT32	NA	-9999 = fill
DHR average count Count of DHR values used in average.	Band, XDim, YDim	INT32	NA	NA
DHRPAR average Average of DHR integrated over the Photosynthetically Active Radiation (PAR) band.	XDim, YDim	FLOAT32	NA	-9999 = fill
DHRPAR average count Count of DHRPAR values used in average.	XDim, YDim	INT32	NA	NA

Table 10-11: CGLS Grid Dataset Description

Field Name Parameter Description	Dimensions List	Number Type	Units	Flag Values
DHR Shortwave approximation average Average of DHR for a broad shortwave band (400-2500 nm), approximated from visible bands ^b .	XDim, YDim	FLOAT32	NA	-9999 = fill
DHR Shortwave approximation average count Count of DHRPAR values used in average	XDim, YDim	INT32	NA	NA
FPAR average Average of Fractional absorbed Photosynthetically Active Radiation (FPAR). Defined as PAR irradiance absorbed by live vegetation divided by incident PAR irradiance.	XDim, YDim	FLOAT32	NA	-9999 = fill
FPAR average count Count of FPAR values used in average	XDim, YDim	INT32	NA	NA
LAI average Average of Leaf Area Index (LAI).	XDim, YDim	FLOAT32	NA	-9999 = fill
LAI average count Count of LAI values used in average	XDim, YDim	INT32	NA	NA
NDVI average Average of Normalized Difference Vegetation Index (NDVI).	XDim, YDim	FLOAT32	NA	-9999 = fill
NDVI average count Count of NDVI values used in average	XDim, YDim	INT32	NA	NA

a. This is a flag field. If the value is 0, then all of the other fields in the GeorectifiedRadianceAverage grid will contain fill data for the grid cell location. However, even if the flag is 1 other fields might still contain fill data. This is used during processing to avoid looking at grid cells that are certain not to have data.

b. See “Hemispherical reflectance and albedo estimates from the accumulation of across-track sun-synchronous satellite data”, Weiss M, Baret F, Leroy M, Begue A, Hautecoeur O, Santer R, Journal of Geophysical Research-Atmospheres 104: (D18) 22221-22232 September 27 1999.

11.0 MISR LEVEL 3 JOINT PRODUCTS

TBD.





APPENDIX A: MISR GEOREGISTRATION INFO

A.1 Introduction

The concept of multi-angle imaging, which is being pioneered by the MISR experiment, is distinct in several ways from traditional nadir-viewing, scene-based multi-spectral imaging. The design of MISR data products was shaped largely by the stringent requirements of the experiment. Users of MISR data have requested clarification about product attributes such as the Space Oblique Mercator (SOM) map projection, the stacked-block HDF-EOS Grid format, and the large size and geographical extent of MISR files. This document provides background information on such topics. It also describes the most precise method for extracting georegistration information directly from MISR files.

There are two ways to determine the latitude and longitude of a pixel within a MISR file. The first method involves reading values directly from an ancillary file called the Ancillary Geographic Product (AGP). Because of data volume considerations, it was not practical to include this redundant information within MISR product files. AGP values are reported at a single resolution. Therefore, interpolation may be required to determine Lat/Lon for a particular desired resolution. The AGP is described in detail in section [9.4] of the parent document[1]. There is one AGP for each Terra orbital path. The MISR AGP is available for public distribution at the Langley DAAC.

The second method for determining lat/lon is much more flexible and requires no ancillary files. The crux of this operation involves coordinate conversions between MISR (block,line,sample), SOM(X,Y), and Lat/Lon. These conversions are supported by orbital parameters and projection information embedded within all MISR products. Such conversions are readily accomplished using HDF-EOS library access routines and the accompanying GCTP map projections library[3]. More complex operations, such as resampling an entire scene to another map projection, are not difficult once the fundamental conversions described herein are understood.

Individuals who are familiar with the MISR experiment, MISR data products, HDF-EOS, the SOM map projection and the GCTP software library may wish to proceed directly to the sections describing coordinate conversion [A.5]. However, most users will save time by perusing the Background sections first. Information about key Metadata values required for coordinate conversions has been condensed for quick-reference into the Metadata Details section[§A.6]. Example C function calls can be found at the end of this document to clarify the function call interfaces that are used in the algorithm described in [A.5]

A.2 Background: The Instrument

The Multi-angle Imaging SpectroRadiometer (MISR) is a new and unique type of satellite instrument. As the Terra satellite moves in its descending polar orbit, each of 9 MISR cameras images the same daylit ground swath, which is 1504 detector samples wide by roughly 70,000 lines long. MISR obtains images for any pixel in the swath from 9 different angles in four different wavelengths. Many remote sensing experiments make use of spectral information to measure physical



properties of the Earth's surface, vegetation, atmosphere and clouds. The novel goal of the MISR design is to make use of angular information as well as spectral. The trouble is that this ambitious scientific task cannot be accomplished unless the 36 pixels MISR obtained for each location can be registered together accurately. (9 cameras x 4 bands = 36). An additional complication in the instrument configuration is that not all 4 bands are acquired at the same resolution in all cameras. In fact, in Global Science mode, the MISR nadir camera is the only one with all four bands at high resolution (275 meters). The other 8 cameras produce red band data at 275 m resolution, but the remaining channels are averaged to 1.1 km resolution. MISR also has a Local Science Mode in which all 36 channels are temporarily acquired at 275 m resolution over a selected scene.

Figure A-1 Artist's Rendition of MISR aboard Terra and sample MISR images.

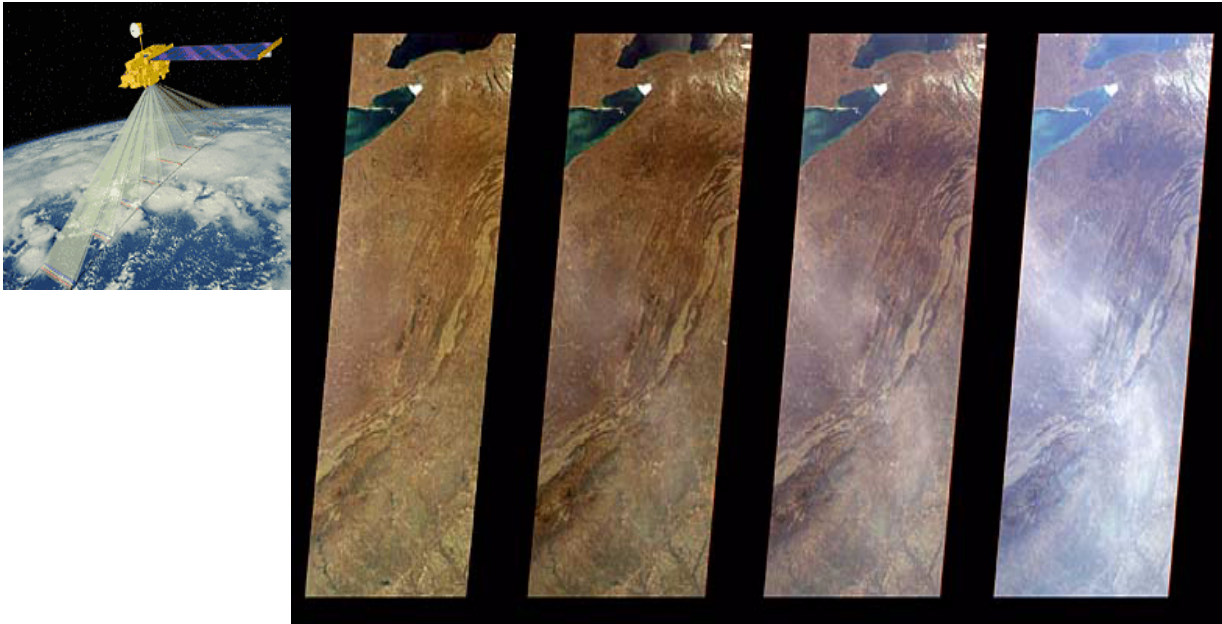

The artist's rendition above of MISR viewing 9 different scenes simultaneously is contrasted with four MISR images of the Eastern United States over the Appalachian Mountains. The image on the left is the nadir image. The other images, taken by the 45.6-degree, 60.0-degree, and 70.5-degree forward-viewing cameras progressively reveal atmospheric haze which was not apparent in the nadir image.

The diagrams on the next page illustrate the concept that each MISR camera eventually views one ground point at a slightly different time from a different angle as the spacecraft passes over that point. One could imagine an extremely long virtual instrument which could view a scene from many different vantages at once. In essence, this is what MISR does. There is a time lag of several minutes between the most forward and most aftward observations. This lag is short enough so that scene changes are small, except for wind-driven cloud motion. The problem of co-registration of data from the different cameras is handled by resampling data from each channel onto a common map projection. This common map projection, called SOM, is described in the next section.

Figure A-2 Diagrams depicting the Multi-Angle concept

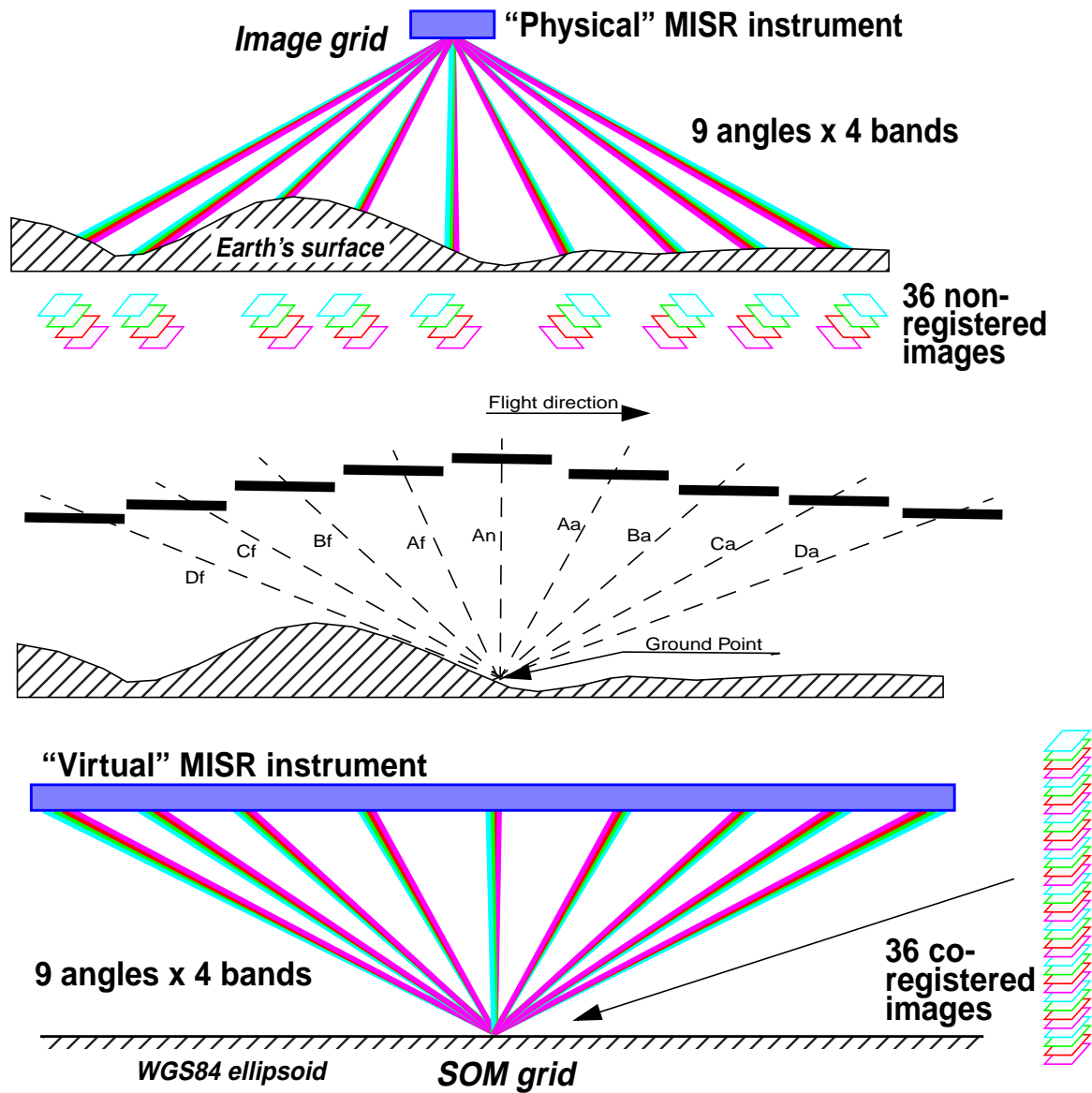

A.3 Background: The SOM Projection

MISR acquires data continuously down the entire daylight side of its orbit. The resulting image is a long, narrow “shoestring” swath which covers a vast geographic range. The SOM map projection was designed for Landsat to support continuous images of this extent. SOM is an acronym for Space Oblique Mercator. In SOM, shape distortion and scale errors are negligible throughout the length of the MISR swath near the satellite ground track. By putting MISR products in the SOM

map projection, the complications of projection distortion were removed from geophysical algorithm development and data processing strategy.

Figure A-3 Sample Partial MISR Swath in SOM vs. Distorted Geographic Lat/Lon



For the majority of MISR data products, SOM is used as the reference map projection. The downside to this scheme is that most users are not familiar with SOM. The following is a brief explanation of the qualitative differences between SOM coordinates and Lat/Lon coordinates. It is by no means a comprehensive introduction to the projection, which is best left to the projection's designer Snyder[2].

Paths: Polar-orbiting satellites such as Landsat and Terra follow a pattern of orbits which repeats after 233 unique orbits in order to cover the entire globe. Each of the 233 possible orbits is called a path. SOM defines a separate projection for each of these 233 paths. For MISR, a path begins at a particular longitude as the satellite crosses the ascending nightside equator. This is referred to as the longitude of the ascending node. Whenever you are dealing with SOM coordinates, you must specify which path is of concern. This path implies a specific longitude of ascending node, which implies a specific SOM projection applicable to that path. All of this information is contained in the MISR product.

(X,Y): SOM coordinates, are called X and Y with units of meters. The X axis points more or less in the direction of satellite groundtrack motion, with the Y axis perpendicular to it. See figure below. The origin of the X axis is at the ascending node equator crossing. To give some feel for the scope of SOM coordinates, X=0 at the dark side equator, X=10 million meters near the North Pole, X=20 million meters at the descending dayside equator crossing, X=30 million meters near the South Pole, and X approaches 40 million meters near the next ascending node. Once the ascending node is reached, X values start over at 0 for the next path/projection.

(Y): SOM Y values may be negative or positive depending upon the side of the X axis on which the location falls. Relevant Y values do not continually increase for the duration of the orbit as X values do. The ground track of the satellite actually follows a nearly sinusoidal curve along the X axis (Y=0); so, at some points on the earth, relevant Y values will be consistently larger than at others, and during a given portion of the orbit, they will be either dominantly positive or negative. The amplitude of the sine curve is about 1 million meters. It is good to note where your area of interest falls on the sine curve in order to determine whether or not you are getting appropriate X,Y values. In general, SOM Y values should be within the range +/- 1 or 2 million meters to stay within the MISR swath at the extremities of the sine curve.

Another SOM attribute to be wary of is that SOM Y is not analogous to longitude. Y indicates how far left or right you are from the SOM X axis, but near the poles this can be a north/south shift, whereas at the equator, changing Y is more east/west in orientation. At the equator, the SOM X axis is inclined about 8 degrees from perpendicular to the equator.

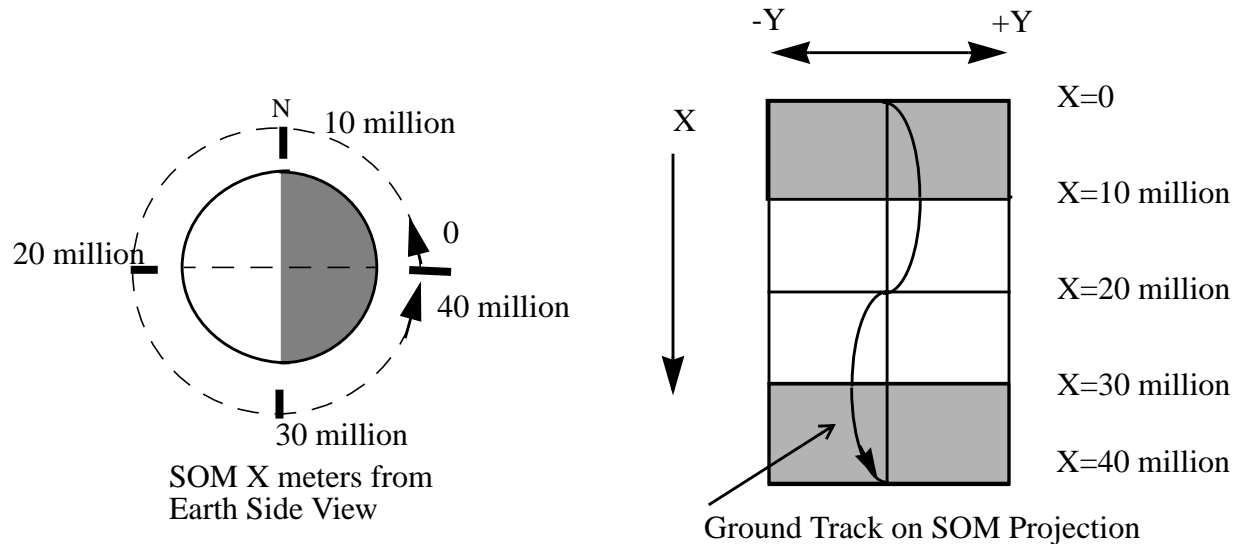

Figure A-4 Attributes of SOM coordinates

Width: It is also important to note that if you are “relatively near” the ground track, any lat/lon \leftrightarrow SOM coordinate conversion you perform will be “reversible” to a reasonable degree of accuracy. On the other hand, if you are very far from the ground track, conversions may not appear to be accurate when reversed. This is caused by a combination of the numerical limitations within the conversion software. (The terms “relatively near” and “very far” are not strictly defined. Suffice it to say that the MISR swath, which extends a few hundred kilometers on either side of the ground track, has been deemed safe by MISR photogrammetrists.) The general lesson to be learned is that you need to know which path you are on, and where the orbit ground track is, and then stay near it in order to get satisfactory performance with SOM coordinate conversions.

Line/Sample: Pixels in a MISR product are arranged in a regular 2-D array in SOM space. The indices to the array are called absolute line and sample, where line increases from top to bottom and sample increases from left to right. Therefore, if you know the SOM X,Y coordinates of any one point in the swath, you can deduce the SOM coordinates of any other point in the swath if you know the pixel resolution and absolute line/sample offset. Beware that the line and sample values in a MISR file are block-relative. They are not absolute.

Blocks: There is one added complication to SOM in MISR products. In order to simplify the job of processing and storing data over this immense geographical area, each MISR path was cut up into a series of pre-defined, uniformly-sized SOM boxes along the ground track. Each box-shaped region is called a Block. MISR blocks are similar to Landsat rows. Block-relative line and sample restart at 0,0 at the top left corner of each block. Therefore, a trivial conversion is required to determine the SOM coordinates of a given pixel in a MISR file, specified as (block, line, sample). Once SOM (X,Y) meters are known, GCTP coordinate conversion software[3] may be used convert between SOM coordinates and Lat/Lon.

A.4 Background: HDF-EOS

HDF-EOS Grid: All MISR products are in the HDF 4 format. However, it is easier to interpret the structures in MISR files if one realizes that they are actually HDF-EOS structures. The EOS project designed specialized data types and access routines on top of HDF 4. These datatypes and the software libraries that read and write them are referred to collectively as HDF-EOS. The earliest products in the MISR production chain (L1A and L1B1) are single-camera HDF-EOS Swath data types. In HDF terminology, a Swath is just a big long SDS or array. Swaths contain no geolocation information other than the time at which a line was acquired. Most users are not interested in this raw Swath format. Instead, they wish to access map-projected data so that they can compare different measurements at a particular geographic location. The HDF-EOS data type for map-projected data is called “Grid.” The HDF-EOS Grid model include metadata structures to store and software support to manipulate orbital parameters and map projection parameters along with the data. Most MISR data products consist of HDF-EOS Grid structures along with specific EOS-defined metadata entities. In theory, it should be very easy to retrieve location information for any MISR pixel in any map projection desired.

“Stacked Block” Grid: The trouble is that MISR data doesn’t fit into the HDF-EOS Grid model very well. The designers of HDF-EOS Grid envisioned small, rectangular maps. Each MISR data swath is a long, curving shoestring which cuts through a huge range of latitudes and longitudes. A single Grid (rectangle) encompassing a typical MISR orbit would have to span the entire globe to bound the shoestring. Grids this large were thought to be intractable in the early days of EOS. So, the EOS project defined a special extension to the Grid model for MISR called “stacked block.” A MISR block is an arbitrarily-sized SOM rectangle on the Earth. A MISR data swath could be contained in a series of adjacent blocks instead of one huge Grid. The blocks are stacked one on top of another so that the vertical offset is a constant SOM X distance. The lateral offset is not constant. (See the diagram below)

Block Offsets: A block may be placed directly beneath the one above it, or it may be shifted by an integral multiple of 17.6 km in the lateral (+/- SOM Y) direction. These shifts are all pre-defined so that the blocks comfortably span the Terra ground track to encompass a MISR data swath. Here the terminology becomes a little bit confusing because while each block can be thought of as a separate HDF-EOS Grid, the entire series comprises a single Grid structure in the HDF file. A MISR HDF-EOS Grid is therefore defined for a given path by the coordinates of the first (top) MISR block along with the standard projection metadata and a special array of offsets defining the locations of all subsequent blocks. Each subsequent block may be treated by the user as an independent Grid, provided that its position relative to the top block can be calculated. The HDF-EOS stacked block model involves automated storage and retrieval of offset metadata, but it does not perform offset calculations. Unfortunately, HDF-EOS does not arrange or assemble multiple blocks either.

Use Patterns: Two primary access paradigms have been noticed. Some users pull one block at a time out of a MISR product and use it in SOM space. Such users are often MISR-centric and manipulate data with their own software. Other users wish to pull out a geographically-defined subset of MISR data which may be smaller than one block or which may entail several blocks. The later type



of user often prefers to work with the data in some map projection other than SOM with a commercial Image Processing or GIS software tool. In either case, familiarity with the MISR internal data representation is helpful.

Figure A-5 Depiction of MISR Stacked Block Grid spacecraft ground track

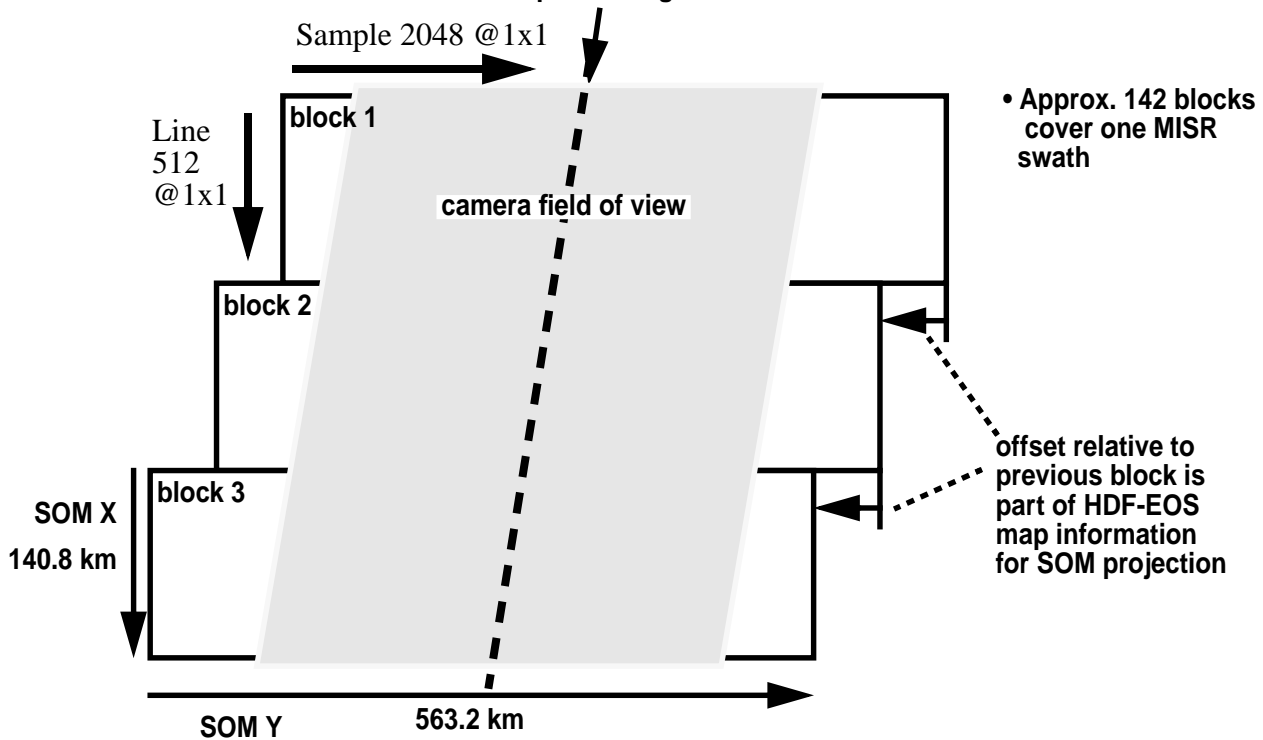

Surprises: There are several idiosyncrasies worth noting at this point. Notice that the MISR image does not fill the entire block. The unused edges of the block contain fill value. The extra room is needed for several reasons. First, the spacecraft ground track is actually inclined slightly with respect to the SOM X axis. Second, not all nine camera footprints overlap precisely. Third, the union of camera footprints gets wider within the blocks at higher latitudes as the overlap gets smaller. This is due to Earth rotation and fixed camera geometry. Finally, each block may be shifted left or right of those adjacent to it by some multiple of 17.6 km in order to follow the groundtrack.

180 Blocks: For each MISR orbit path, a set of 180 SOM blocks has been predefined. The 180 blocks cover a range larger than the daylit Earth in order to account for seasonal variations in the positions of day/night terminators. MISR only acquires data on the dayside of the terminator. For a single orbit, the terminator-to-terminator range in blocks is roughly 142. Therefore, MISR files contain data structures representing 180 blocks, but data is only found in 142 or fewer of these blocks. During winter months, for instance, the first 20 blocks of a MISR Grid may be vacant.

Figure A-6 MISR Blocks Follow the Curving Swath

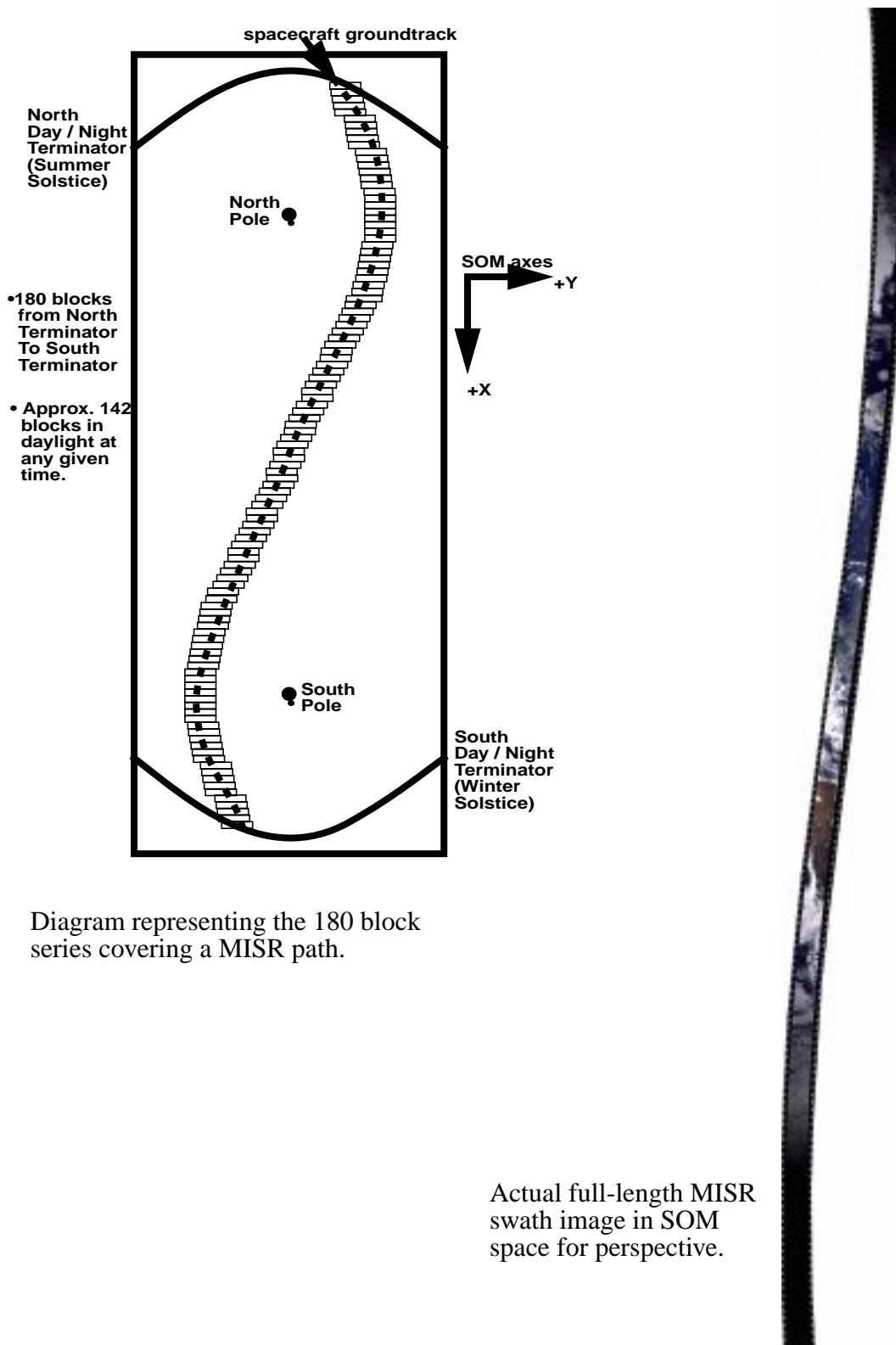

Diagram representing the 180 block series covering a MISR path.

Actual full-length MISR swath image in SOM space for perspective.



A.5 Coordinate Conversions

The following three subsections [A.5.1], [A.5.2], and [A.5.3] describe the steps required to perform accurate coordinate conversions on pixel locations in a MISR file. The descriptions include the extraction of metadata necessary to perform the conversions. A complete description of MISR file metadata relevant to these conversions is provided in section [A.6]. Example function calls relevant to these conversions in the C language are printed in section [A.7]. An assumption is made that the user has access to the HDF-EOS libraries, including the GCTP map projection library[3].

Forward Conversion: Lat/Lon->(block, line, sample) = [Lat/Lon-> SOM ->(block, line, sample)]

Given a position specified by Lat/Lon, two steps are required to determine the MISR block, line and sample coordinates. 1) Convert Lat/Lon to SOM(X,Y) meters using the GCTP conversion software. 2) Then convert SOM(X,Y) to MISR (block, line, sample). Forward conversion is useful for resampling MISR data to another map projection. GCTP supports conversions from Lat/Lon to other projections using the same metadata required for the SOM->Lat/Lon conversion. Beware that the line and sample results for an arbitrary position may be fractional.

Inverse Conversion: (block, line, sample)->Lat/Lon = [(block, line, sample)->SOM->Lat/Lon]

Given a MISR pixel, as specified by block number, line number within block and sample number within block, two inverse steps are required to determine the Latitude and Longitude of the pixel center. 1) Convert (block, line, sample) to SOM(X,Y) meters. 2) Then convert SOM(X,Y) to Lat/Lon using the GCTP conversion software. The orbit path must be known a priori; metadata from the MISR product file in question is required; and the HDF-EOS software library along with GCTP must be utilized. Inverse conversion is useful for determining the location of features within native MISR data for comparison with other datasets.

Precision: Coordinate Conversions are reversible (Forward<->Inverse) with reasonable numerical precision only for positions near the satellite groundtrack. Positions within the MISR data swath are thus reversible. Positions that are not near the satellite groundtrack are often better-described on another path and SOM projection. Therefore, coordinate conversions involving such positions are often not reversible. The causes of this limitation include map projection distortion as well as numerical approximation used in the algorithms in GCTP. The example function calls in section [A.7] provide a good use case to emulate.

A.5.1 SOM <-> Lat/Lon

Inverse: SOM -> Lat/Lon Given a pixel's position in SOM (X,Y) meters, assuming a particular orbit path, the following steps should be used to determine the corresponding Latitude and Longitude.

- a) Choose a MISR product file with the appropriate orbit path and read from it the HDF-EOS projection params using the call GDprojinfo(). The projection params define the SOM projec-

tion used for this path. Users wishing to avoid HDF-EOS may refer to the Metadata Details section for choices for direct HDF reads of projection parameter info.

- b) Convert the SOM coordinates to Lat/Lon with the GCTP library calls `inv_init()` and `sominv()`. `inv_init` takes the projection parameters from step a. as arguments.¹ Beware that the order of the arguments to `sominv(som_x, som_y, &lon, &lat)` is neither intuitive nor well-documented.² See section [A.7] for examples.

Forward: Lat/Lon -> SOM Given a pixel's position in Lat/Lon coordinates assuming a particular MISR orbit path, the following steps should be used to determine the corresponding coordinates in SOM (X,Y) meters.

- a) Choose a MISR product file with the appropriate orbit path and read from it the HDF-EOS projection params using the call `GDprojinfo()`. The projection params define the SOM projection used for this path. Users wishing to avoid HDF-EOS may refer to the Metadata Details section for choices for direct HDF reads of projection parameter info.
- b) Convert the Lat/Lon coordinates to SOM with the GCTP library calls `for_init()` and `somfor()`. `for_init` takes the projection parameters from step a. as arguments.³ Beware that the order of the arguments to `somfor(lon, lat, &som_x, &som_y)` is neither intuitive nor well-documented.

A.5.2 Inverse: MISR(block, line, sample) -> SOM(X,Y)

Given a MISR pixel specified by (block, line, sample), assuming a particular orbit path, the following steps should be used to determine the corresponding SOM(X,Y) coordinates in meters.

- a) Pick a MISR file to read which corresponds to the orbit path in question.
- b) Read origin block coords and block/pixel sizes for a band using `HDF-EOS GDgridinfo()`^{4 5}

From the origin coords (`ulc[]`, `lrc[]`) and the sizes (`Xdim`, `Ydim`), compute the following values:

-
1. The GCTP coordinate conversion library provides routines for converting between lat/lon and many other map projections. MISR uses the GCTP SOM projection A by default based on the projection parameter values. SOM A specifies the inclination angle and longitude of the ascending node unlike SOM B, which uses path number and is specific to Landsat.
 2. In HDF-EOS, Lat/Lon coordinates are specified in degrees. GCTP functions expect Lat/Lon in radians.
 3. `GDprojinfo()` actually returns the HDF-EOS projection parameters array which corresponds directly to the one required for the GCTP SOM initializations; but in addition, it returns the projection code (22 for SOM), the zone code (unused for SOM) and the spheroid code (WGS84 ellipsoid 12), all of which are required to call the GCTP routines. See [4] for more info.

ULC.x = ulc[0]	!! JUST DO THIS. It is not a typo.
ULC.y = lrc[1]	!! Swapping ULC.y and LRC.y is a
LRC.y = ulc[1]	!! side-effect of an unusual definition of
LRC.x = lrc[0]	!! lrc vs. ulc in HDFEOS.[4]
$S_x = (LRC.x - ULC.x) / Xdim$!! Size of pixel in line direction in meters
$S_y = (LRC.y - ULC.y) / Ydim$!! Size of pixel in sample direction in meters

c) Adjust ULC coordinates from pixel corner to pixel center.

$ULC.xc = ULC.x + (S_x / 2.0)$

$ULC.yc = ULC.y + (S_y / 2.0)$

d) Read the block offsetArray using the HDF-EOS call GDblkSOMoffset(). It returns an array of offsets specified in pixels at S_x resolution. Each offset is relative to the block above. The HDF-EOS call actually reads from the vdata structure `_BLKSOM:<gridname>`.

e) Calculate SOM.x and SOM.y for BlockNumber(**b**), pixel(**line**, **sample**) as:

$SOM.x = ULC.xc + [(b - 1) * Xdim * S_x] + (line * S_x)$

$SOM.y = ULC.yc + [sample + offset] * S_y$ where $offset = \sum_{i=0}^{b-2} offsetArray[i]$

A.5.3 Forward: SOM(X,Y) -> MISR (block, line, sample)

Given a position in SOM(X,Y) meters, assuming a particular orbit path, the following steps should be used to determine the corresponding MISR pixel in (block, line, sample) coordinates.

- Pick a MISR file to read which corresponds to the orbit path in question.
- Read origin block coords and block/pixel sizes for a band using HDF-EOS GDgridinfo().

From the origin coords (ulc[], lrc[]) and the sizes (Xdim, Ydim), compute the following values:

ULC.x = ulc[0]	!! JUST DO THIS. It is not a typo.
ULC.y = lrc[1]	!! Swapping ULC.y and LRC.y is a

4. Though it is recommended, the user does not have to use HDF-EOS routines to read relevant metadata values. If some other means of accessing MISR files is desired, see "Metadata Details" on page 313. Beware that the definitions of ULC.y and LRC.y are not the same for all metadata fields!

5. Each MISR band may be of a different resolution. So, you need to obtain the 1st block origin coordinates and the block and pixel size information using the HDF-EOS call GDgridinfo() which reads from the textual StructMetaData. StructMetaData is present in all MISR HDF files. The GDgridinfo() call returns: Xdim, Pixels per block in line direction; Ydim Pixels per block in sample direction; ulc[0..1] Origin Block Corner Coords SOM meters; lrc[0..1] Beware, names aren't intuitive! See "Metadata Details" on page 313

$LRC.y = ulc[1]$!! side-effect of an unusual definition of
 $LRC.x = lrc[0]$!! lrc vs. ulc in HDFEOS.
 $S_x = (LRC.x - ULC.x) / Xdim$!! Size of pixel in line direction in meters
 $S_y = (LRC.y - ULC.y) / Ydim$!! Size of pixel in sample direction in meters

c) Adjust ULC coordinates from pixel corner to pixel center.

$ULC.xc = ULC.x + (S_x / 2.0)$

$ULC.yc = ULC.y + (S_y / 2.0)$

d) Convert SOM meters to local SOM representation in pixels relative to first block in this file.

$SOM.xpix = (SOM.x - ULC.xc) / S_x$

$SOM.ypix = (SOM.y - ULC.yc) / S_y$

e) Determine the block number.

$Block = \text{floor}((SOM.xpix + 0.5) / Xdim) + 1$!! Coords are within this block.¹

f) Determine line number within predetermined block.

$Line = SOM.xpix - ((Block - 1) * Xdim)$

g) Read the block offsetArray using the HDF-EOS call GDBlkSOMoffset(). It returns an array of offsets specified in pixels at S_x resolution. Each offset is relative to the block above.

h) Determine the sample coordinate within the predetermined block.

$Sample = SOM.ypix - \text{offset}$ where $\text{offset} = \sum_{i=0}^{Block-2} \text{offsetArray}[i]$

A.6 Metadata Details

There are a handful of characteristics of MISR Grid files which are critical for accurate and efficient data access. For instance, each MISR Grid is 180 blocks in length; however, roughly 142 sequential blocks actually contain valid data. File-Global metadata attributes Start_block and End Block tell the user the range and location of valid blocks within the 180 defined in the hdf file. The externally-mandated definitions of HDF-EOS Grid ULC and LRC are inverted for SOM! Therefore some coordinates in the table must be swapped. They are noted. Other custom metadata fields are very handy to know about. The following table allows users without access to HDF-EOS libraries to obtain critical geo-related metadata from the most convenient sources.

Note: All metadata coordinates refer to outside corner locations, not to centers of corner-pixels. Metadata values base-1

1. Real code should check Block, Line and Sample coordinates against valid ranges. Also, do not be fooled by X/Y inversion from standard video definition. See section "Background: The SOM Projection" on page 303



by convention. Block number is the most common example. Software developers often expect base-0, so beware.

Table A-1: MISR Metadata Sources

Metadata Location	Structural	Core	Gbl. File Attr.*	Grid Attr.*	Per Block Common Vdata*
Projection Parameters	ProjParams		various SOM_...		
OriginBlock Coordinates	UperLeftPointMtrs LowerRightMtrs - SOM meters - Beware! Y coordinates swapped				Block_coor_ulc_som: _meter.x _meter.y Block_coor_lrc_som: _meter.x _meter.y
All Block Coordinates		GRINGPOINTLONGITUDE GRINGPOINTLATITUDE - Lat/Lon - Order(ULC, LLC, LRC, URC)			see above
Pixels per Block	XDim YDim			Block_size.size_x Block_size.size_y	
Pixel Size	(Derivable)			Block_size.resolution_x Block_size.resolution_y	
Block Offset Ary.	Special HDF-EOS vdatas, one per grid named _BLKSOM:<gridname>				
Valid Block Range			Start_block End block		
* indicates MISR-unique metadata structure vs. standard ECS-required metadata.					

A.7 Example Function Calls

The examples in this section illustrate the coordinate conversion scenarios described in this appendix. The GCTP software package is used to convert between SOM and Lat/Lon coordinates. C Programmers often understand C better than English. These examples are intended to address detailed questions about function interfaces, units and adjustments. Such issues are more easily addressed in this way than in prose. These examples are strictly intended for educational purposes.

In the following example scenario, map projection parameters are read from a real MISR HDF-EOS Grid file. Example coordinate conversions are made, and the function calls to HDF and GCTP library routines are shown in the proper sequence with proper arguments.

`misrcoordex.c` outlines a series calls to the example functions, HDF-EOS and the GCTP library to perform full MISR->Lat/Lon and Lat/Lon->MISR conversions.

`misr_init()` illustrates setup steps which simplify the remaining examples. It should be called done prior to calling `misrfor()` or `misrinv()`. These steps, mentioned in sections [A.5.2] and [A.5.3], include converting from relative to absolute coordinates and the swapping of `ulc/rlc` values.

`misrfor()` illustrates the forward conversion $SOM(X,Y) \rightarrow (\text{block, line, sample})$ described in Section A.5.3 on page 312.

`misrinv()` illustrates the inverse conversion $(\text{block, line, sample}) \rightarrow SOM(X,Y)$ described in Section A.5.2 on page 311.

The files `misrproj.h` and `errormacros.h` are headers included by the other examples to remove extraneous code so that the examples are more concise.

The Makefile shows how to include from and link to the necessary pieces of the GCTP, HDF and HDF-EOS libraries needed to complete the scenario.

The basic scenario outlined in `misrcoordex.c` is:

- a. Use HDF-EOS to read necessary info from a MISR product.
- b. Call `misr_init()` and `som_init()` once with the info read from the MISR product.
- c. use combinations of `(somfor()+misrfor())` or `(misrinv()+sominv())` to perform as many forward or inverse coordinate conversions as desired on this orbit path.

A.7.1 misrcoordex.c

```

#include <stdio.h>
#include <stdlib.h>
#include <string.h>
#include <hdf.h>
#include <HdfEosDef.h>
#include <proj.h>
#include "misrproj.h"
#include "errormacros.h"

#define MAXNDIM 10

typedef struct {
    int block;
    float line;
    float sample;
} pts_t;

int npts = 40;
pts_t pts[] = { { 1, -0.5, -0.5 }, \
{ 1, -0.499999, -0.499999 }, \
{ 1, 0.0, 0.0 }, \
{ 1, 0.5, 0.5 }, \
{ 1, 127.0, 511.0 }, \
{ 1, 127.5, 511.5 }, \
{ 1, 511.0, 2047.0 }, \
{ 1, 511.5, 2047.5 }, \
{ 1, 101.97, 64.23 }, \
{ 1, 101.0, 64.0 }, \
{ 65, -0.5, -0.5 }, \
{ 65, -0.499999, -0.499999 }, \
{ 65, 0.0, 0.0 }, \
{ 65, 0.5, 0.5 }, \
{ 65, 127.0, 511.0 }, \
{ 65, 127.5, 511.5 }, \
{ 65, 511.0, 2047.0 }, \
{ 65, 511.5, 2047.5 }, \
{ 65, 101.97, 64.23 }, \
{ 65, 101.0, 64.0 }, \
{ 91, -0.5, -0.5 }, \
{ 91, -0.499999, -0.499999 }, \
{ 91, 0.0, 0.0 }, \
{ 91, 0.5, 0.5 }, \
{ 91, 127.0, 511.0 }, \
{ 91, 127.5, 511.5 }, \
{ 91, 511.0, 2047.0 }, \
{ 91, 511.5, 2047.5 }, \
{ 91, 101.97, 64.23 }, \
{ 91, 101.0, 64.0 }, \
{ 180, -0.5, -0.5 }, \
{ 180, -0.499999, -0.499999 }, \
{ 180, 0.0, 0.0 }, \
{ 180, 0.5, 0.5 }, \
{ 180, 127.0, 511.0 }, \
{ 180, 127.5, 511.5 }, \
{ 180, 511.0, 2047.0 }, \
{ 180, 511.5, 2047.5 }, \
{ 180, 101.97, 64.23 }, \
{ 180, 101.0, 64.0 }, \
};

int main(int argc, char *argv[]) {

    int32 fid = FAIL;
    int32 gid = FAIL;
    int igrid, i;
    int32 ngrid;
    int32 nline, nsample;
    double lat_r, lon_r;
    double savelon_r1, savelon_r2;
    double somx, somy;
    int b;
    float l, s;
    int32 strbufsize;

```



```

char      *filepath;
char      **gridname;
char      *gridlist;
float64   ulc[2], lrc[2];
int32     spherecode, zonecode, projcode;
float64   projparam[NPROJ];
float32   offset[NOFFSET];
long      iflg;
int       status;
char      diff_flg;
int32     dim[MAXNDIM];
char      dimlist[STRLEN];
intn      hdfsos_status_code;
void      *mem_status_code;
long      (*for_trans[MAXPROJ+1])();
long      (*inv_trans[MAXPROJ+1])();

/* ----- */
/* Check arguments */
/* ----- */

if (argc != 2) {
    fprintf(stderr, "Usage: %s hdfsos_grid_file\n", argv[0]);
    exit(1);
}
filepath = argv[1];

/* ----- */
/* Inquire and allocate memory for the hdfsos gridnames */
/* This is only require if you need the gridnames */
/* ----- */

hdfsos_status_code = GDinqgrid(filepath, NULL, &strbufsize);
HDFSOS_ERROR_CHECK("GDinqgrid");

mem_status_code = gridlist = (char *)malloc(strbufsize+1);
MEM_ERROR_CHECK("malloc");

hdfsos_status_code = ngrid = GDinqgrid(filepath, gridlist, NULL);
HDFSOS_ERROR_CHECK("GDinqgrid");

mem_status_code = gridname = (char **)malloc(ngrid * sizeof(char *));
MEM_ERROR_CHECK("malloc");

gridname[0] = strtok(gridlist, ",");
for (igrid = 1; igrid < ngrid; igrid++) gridname[igrid] = strtok(NULL, ",");

/* ----- */
/* Open the hdfsos grid file */
/* ----- */

hdfsos_status_code = fid = GDopen(filepath, DFACC_READ);
HDFSOS_ERROR_CHECK("GDopen");

/* ----- */
/* Loop through all the grids because I can */
/* ----- */

for (igrid = 0; igrid < ngrid; igrid++) {

    /* ----- */
    /* Attach to the grid of choice */
    /* ----- */

    hdfsos_status_code = gid = GDattach(fid, gridname[igrid]);
    HDFSOS_ERROR_CHECK("GDattach");

    /* ----- */
    /* Inquire grid dimensions to check number of blocks */
    /* Inquire grid info to get the number of lines/sample and ulc/lrc */
    /* Inquire SOM relative block offsets */
    /* Initialize misr block/line/sample projection routines */
    /* ----- */

    hdfsos_status_code = GDinqdims(gid, dimlist, dim);
    HDFSOS_ERROR_CHECK("GDinqdims");
}

```



```

if (dim[0] != NBLOCK) ERROR("File does not have 180 blocks");

hdfeos_status_code = GDgridinfo(gid, &nline, &nsample, ulc, lrc);
HDFEOS_ERROR_CHECK("GDgridinfo");

hdfeos_status_code = GDblkSOMoffset(gid, offset, NOFFSET, "r");
HDFEOS_ERROR_CHECK("GDblkSOMoffset");

status = misr_init(NBLOCK, nline, nsample, offset, ulc, lrc);
if (status) ERROR("misr_init");

printf("\nFilename (path/orbit): %s\n", filepath);
printf("Gridname: %s\n", gridname[igrid]);
printf("Lines/Samples: (%d, %d)\n", nline, nsample);
printf("ULC (x,y) (m): (%f, %f)\n", ulc[0], ulc[1]);
printf("LRC (x,y) (m): (%f, %f)\n", lrc[0], lrc[1]);
printf("Block offsets: (%f", offset[0]);
for (i = 1; i < NOFFSET; i++) printf(", %f", offset[i]);
printf(")\n");

/* ----- */
/* Inquire grid projection info to get project codes/parameters */
/* Initialize gctp SOM forward and inverse projection routines */
/* ----- */

hdfeos_status_code = GDprojinfo(gid, &projcode, &zonecode,
                                &spherecode, projparam);
HDFEOS_ERROR_CHECK("GDprojinfo");

for_init((long)projcode, (long)zonecode, (double*)projparam,
         (long)spherecode, NULL, NULL, &iflg, for_trans);
if (iflg) ERROR("for_init");

inv_init((long)projcode, (long)zonecode, (double*)projparam,
         (long)spherecode, NULL, NULL, &iflg, inv_trans);
if (iflg) ERROR("inv_init");

printf("GCTP projection code: %d\n", projcode);
printf("GCTP zone code (not used for SOM): %d\n", zonecode);
printf("GCTP sphere code: %d\n", spherecode);
printf("GCTP projection parameters: (%f", projparam[0]);
for (i = 1; i < NPROJ; i++) printf(", %f", projparam[i]);
printf(")\n");

/* ----- */
/* Detach from the grid because we don't need it anymore in this example */
/* We would need it if we go on to access fields, so don't detach here */
/* ----- */

if (gid != FAIL) GDdetach(gid);

/* ----- */
/* Loop over some inverse transformations */
/* (b,l,l,s.s) -> (X,Y) -> (lat,lon) */
/* and over some forward transformations */
/* (lat,lon) -> (X,Y) -> (b,l,l,s.s) */
/* ----- */

printf("      (blk,      line ,      sample )      "
       "(      SOM X      ,      SOM Y      )      "
       "(      Lat      ,      Lon      )\n");

for (i = 0; i < npts; i++) {

    b = pts[i].block;
    l = pts[i].line;
    s = pts[i].sample;

    /* ----- */
    /* Inverse transformation (b,l,l,s.s) -> (X,Y) -> (lat,lon) */
    /* ----- */

    misrinv(b, l, s, &somx, &somy); /* (b,l,l,s.s) -> (X,Y) */
    sominv(somx, somy, &lon_r, &lat_r); /* (X,Y) -> (lat,lon) */

    printf("%2d: (%3d,%11.6f,%12.6f) -> (%17.6f,%17.6f) -> "

```



```

        "(%10.6f,%11.6f) --|\n",
        i, b, l, s, somx, somy, lat_r * R2D, lon_r * R2D);

/* ----- */
/* Forward transformation (lat,lon) -> (X,Y) -> (b,l,l,s,s) */
/* ----- */

somfor(lon_r, lat_r, &somx, &somy); /* (lat,lon) -> (X,Y) */
misrfor(somx, somy, &b, &l, &s); /* (X,Y) -> (b,l,l,s,s) */

if (b != pts[i].block) diff_flg = '*';
else diff_flg = ' ';

printf(" %c (%3d,%11.6f,%12.6f) <- (%17.6f,%17.6f) <- "
        "(%10.6f,%11.6f) <-|\n",
        diff_flg, b, l, s, somx, somy, lat_r * R2D, lon_r * R2D);

/* ----- */
/* Save the longitude of block 91 to find location of */
/* equator crossing */
/* ----- */

if (pts[i].block == 91 &&
    pts[i].line == 0.0 &&
    pts[i].sample == 0.0) {
savelon_r1 = lon_r;
}
if (pts[i].block == 91 &&
    pts[i].line == (float)(nline-1) &&
    pts[i].sample == (float)(nsample-1)) {
savelon_r2 = lon_r;
}
}

/* ----- */
/* Determine block/line/sample of the equator crossing */
/* approximately in the center of the block */
/* ----- */

lat_r = 0.0;
if (savelon_r1 < 0.0 && savelon_r2 > 0.0 ||
    savelon_r1 > 0.0 && savelon_r2 < 0.0) {
    lon_r = (savelon_r1 - savelon_r2) / 2.0;
} else {
    lon_r = (savelon_r1 + savelon_r2) / 2.0;
}

/* ----- */
/* Forward transformation (lat,lon) -> (X,Y) -> (b,l,l,s,s) */
/* ----- */

somfor(lon_r, lat_r, &somx, &somy); /* (lat,lon) -> (X,Y) */
misrfor(somx, somy, &b, &l, &s); /* (X,Y) -> (b,l,l,s,s) */

printf("%2d: (%3d,%11.6f,%12.6f) <- (%17.6f,%17.6f) <- "
        "(%10.6f,%11.6f) = equator crossing\n",
        npts, b, l, s, somx, somy, lat_r * R2D, lon_r * R2D);

/* ----- */
/* Extreme upper left corner (not center) */
/* ----- */

somx = ulc[0];
somy = lrc[1]; /* Notice the switch from ulc[1]. */

sominv(somx, somy, &lon_r, &lat_r);
misrfor(somx, somy, &b, &l, &s);

printf("%2d: (%3d,%11.6f,%12.6f) <- (%17.6f,%17.6f) -> "
        "(%10.6f,%11.6f) = ulc of block l\n",
        npts+1, b, l, s, somx, somy, lat_r * R2D, lon_r * R2D);

/* ----- */
/* Extreme lower right corner (not center) */
/* ----- */

```



```

somx = lrc[0];
somy = ulc[1]; /* Notice the switch from lrc[1]. */

sominv(somx, somy, &lon_r, &lat_r);
misrfor(somx, somy, &b, &l, &s);

printf("%2d: (%3d,%11.6f,%12.6f) <- (%17.6f,%17.6f) -> "
      "(%10.6f,%11.6f) = lrc of block 1\n",
      npts+2, b, l, s, somx, somy, lat_r * R2D, lon_r * R2D);

/* ----- */
/* Origin of SOM projection for this path */
/* ----- */

somx = 0.0;
somy = 0.0;

sominv(somx, somy, &lon_r, &lat_r);
misrfor(somx, somy, &b, &l, &s);

printf("%2d: (%3d,%11.6f,%12.6f) <- (%17.6f,%17.6f) -> "
      "(%10.6f,%11.6f) = SOM origin (long of asc node)\n",
      npts+3, b, l, s, somx, somy, lat_r * R2D, lon_r * R2D);

/* ----- */
/* Origin of SOM projection plus 180 degrees longitude */
/* ----- */

lat_r = 0.0;
lon_r = (lon_r > 0.0 ? lon_r - (180.0*D2R) : lon_r + (180.0*D2R));

somfor(lon_r, lat_r, &somx, &somy);
misrfor(somx, somy, &b, &l, &s);

printf("%2d: (%3d,%11.6f,%12.6f) <- (%17.6f,%17.6f) <- "
      "(%10.6f,%11.6f) = SOM origin plus 180 in long.\n",
      npts+4, b, l, s, somx, somy, lat_r * R2D, lon_r * R2D);

/* ----- */
/* Equator crossing using SOM X from above */
/* ----- */

somy = 0.0;

sominv(somx, somy, &lon_r, &lat_r);
misrfor(somx, somy, &b, &l, &s);

printf("%2d: (%3d,%11.6f,%12.6f) <- (%17.6f,%17.6f) -> "
      "(%10.6f,%11.6f) = equator crossing\n",
      npts+5, b, l, s, somx, somy, lat_r * R2D, lon_r * R2D);
}

if (fid != FAIL) GDclose(fid);
if (gridlist) free(gridlist);
if (gridname) free(gridname);

printf("\nNotes:\n\n"
      "1) Given a block, fractional line and fraction sample triplet the\n"
      "following transformations performed:\n\n"
      "Inverse transformation: (b,l.l,s.s) -> (X,Y) -> (lat,lon) -|\n"
      "-----|\n"
      "Forward transformation: |-> (lat,lon) -> (X,Y) -> (b,l.l,s.s)\n\n"
      "2) The transforms marked with a * did not reproduce the same\n"
      "answer either because of rounding errors in the GCTP codes or because\n"
      "they are out of bounds of the particular grid. The misr transform\n"
      "routines (misr_init, misrfor and misrin) are designed to handle out\n"
      "of bounds conditions and return all -1's. This enables a resampling\n"
      "routine to determine whether resampling can be done or not, if these\n"
      "routines are used for reprojection.\n\n"
      "3) Notice that the ULC Y/LRC Y values returned by gridinfo are incorrectly\n"
      "switched when compared to transform number 0, 5 or 7 (depending\n"
      "on resolution).\n\n"
      "4) Also note that the ULC/LRC values returned by gridinfo are for block 1\n"
      "extreme pixel edges (not pixel centers).\n\n"
      "5) Note that SOM X is always increasing as blocks increase (in fact,\n\n"

```



```

"  SOM X is zero meters at the longitude of the ascending node - the\n"
"  5th parameter of projection parameters).  SOM Y tends to be mostly\n"
"  positive in the Northern blocks and negative in the Southern blocks.\n"
"  Each SOM path is a separate projection with the origin at the\n"
"  night side equator and the longitude of the ascending node.\n\n"
"6) The block offsets are the number of 1.1km subregions from the\n"
"  previous block.  The first offset is relative first block.\n\n"
"7) The 4th and 5th projection parameter are in the format of packed\n"
"  dddmmss.ss as documented in the GCTP codes (see paksz.c).\n\n"
"8) MISR uses the GCTP SOM projection A which specifies the inclination\n"
"  angle and longitude of the ascending node instead of path number.\n\n"
"9) The last six transformations compute various special case locations.\n"
"  Note the direction of the transform arrows.  Can you determine why the\n"
"  lrc of block 1 is actually in block 2?  Hint: it is not the pixel\n"
"  center, but rather the edge.\n\n"
"10) Last note.  Remember that the SOM projection is singular at the poles\n"
"  and thus undefined there.\n\n"
"  );
  exit(0);
}

```

A.7.2 misr_init.c

```

#include "misproj.h" /* Prototype for this function */
#include "errormacros.h" /* Error macros */

int nb;
int nl;
int ns;
float absOffset[NBLOCK];
float relOffset[NBLOCK-1];
double ulc[2];
double lrc[2];
double sx;
double sy;
double xc;
double yc;

#define FUNC_NAMEm "misr_init"

int misr_init(
const int  nblock, /* Number of blocks */
const int  nline, /* Number of lines in a block */
const int  nsample, /* Number of samples in a block */
const float relOff[NOFFSET], /* Block offsets */
const double ulc_coord[], /* Upper left corner coord. in meters */
const double lrc_coord[] /* Lower right corner coord. in meters */
)
{
  int i; /* Offset index */
  char msg[STRLEN]; /* Warning message */

  /* Argument checks */

  if (nblock < 1 || nblock > NBLOCK) {
    sprintf(msg, "nblock is out of range (1 < %d < %d)", nblock, NBLOCK);
    WRN_LOG_JUMP(msg);
  }

  /* Convert relative offsets to absolute offsets */

  absOffset[0] = 0.0;
  for (i = 1; i < NBLOCK; i++) {
    absOffset[i] = absOffset[i-1] + relOff[i-1];
    relOffset[i-1] = relOff[i-1];
  }

  /* Set ulc and lrc SOM coordinates */
  /* Note; ulc y and lrc y are reversed in the structural metadata. */

  ulc[0] = ulc_coord[0];
  ulc[1] = lrc_coord[1];

```



```

    lrc[0] = lrc_coord[0];
    lrc[1] = ulc_coord[1];

/* Set number of blocks, lines and samples */

    nb = nblock;
    nl = nline;
    ns = nsample;

/* Compute pixel size in ulc/lrc units (meters) */

    sx = (lrc[0] - ulc[0]) / nl;
    sy = (lrc[1] - ulc[1]) / ns;

/* Adjust ulc to be in the center of the pixel */

    xc = ulc[0] + sx / 2.0;
    yc = ulc[1] + sy / 2.0;

    return(0);

ERROR_HANDLE:
    return(1);
}

```

A.7.3 misrfor.c

```

#include "misrproj.h" /* Prototype for this function */
#include "errormacros.h" /* Error macros */
#include <math.h> /* Prototype for floor */

extern int nb;
extern int nl;
extern int ns;
extern float absOffset[NBLOCK];
extern double ulc[2];
extern double lrc[2];
extern double sx;
extern double sy;
extern double xc;
extern double yc;

#define FUNC_NAME "misrfor"

int misrfor(
const double x, /* Output SOM X coordinate */
const double y, /* Output SOM Y coordinate */
int* block, /* Input block */
float* line, /* Input line */
float* sample /* Input sample */
)
{
    float i; /* Intermediate X coordinate */
    float j; /* Intermediate Y coordinate */
    int b; /* Intermediate block */
    float l; /* Intermediate line */
    float s; /* Intermediate sample */
    char msg[STRLEN]; /* Warning message */

/* Compute intermediate coordinates */

    i = (float)((x - xc) / sx);
    j = (float)((y - yc) / sy);

/* Check for very small numbers in i and j and assume they are zero */

    i = (fabs(i) < 1E-5 ? 0.0 : i);
    j = (fabs(j) < 1E-5 ? 0.0 : j);

/* Compute block and check range */

    b = (int)(floor((i + 0.5) / nl)) + 1;

```



```

    if (b < 1 || b > nb) {
        sprintf(msg, "block is out of range (1 < %d < %d)", b, nb);
        WRN_LOG_JUMP(msg);
    }

/* Compute line and check range */

    l = (float)(i - ((b - 1) * nl));
    if (l < -0.5 || l > nl - 0.5) {
        sprintf(msg, "line is out of range (0 < %e < %d)", l, nl);
        WRN_LOG_JUMP(msg);
    }

/* Compute sample and check range */

    s = (float)(j - absOffset[b-1]);
    if (s < -0.5 || s > ns - 0.5) {
        sprintf(msg, "sample is out of range (0 < %e < %d)", s, ns);
        WRN_LOG_JUMP(msg);
    }

/* Set return values */

    *block = b;
    *line = l;
    *sample = s;

    return(0);

ERROR_HANDLE:

    *block = -1;
    *line = -1.0;
    *sample = -1.0;
    return(1);
}

```

A.7.4 misrinv.c

```

#include "misrproj.h" /* Prototype for this function */
#include "errormacros.h" /* Error macros */

extern int nb;
extern int nl;
extern int ns;
extern float absOffset[NBLOCK];
extern double ulc[2];
extern double lrc[2];
extern double sx;
extern double sy;
extern double xc;
extern double yc;

#define FUNC_NAMEm "misrinv"

int misrinv(
const int    block, /* Input block */
const float  line, /* Input line */
const float  sample, /* Input sample */
double*      x, /* Output SOM X coordinate */
double*      y /* Output SOM Y coordinate */
)
{
    int    n; /* Number of line to current block */
    char   msg[STRLEN]; /* Warning message */

/* Check Arguments */

    if (block < 1 || block > NBLOCK) {
        sprintf(msg, "block is out of range (0 < %d < %d)", block, nb);
        WRN_LOG_JUMP(msg);
    }

    if (line < -0.5 || line > nl - 0.5) {

```



```

    sprintf(msg, "line is out of range (0 < %e < %d)", line, nl);
    WRN_LOG_JUMP(msg);
}

if (sample < -0.5 || sample > ns - 0.5) {
    sprintf(msg, "sample is out of range (0 < %e < %d)", sample, ns);
    WRN_LOG_JUMP(msg);
}

/* Compute SOM x/y coordinates in ulc/lrc units (meters) */

n = (int)((block - 1) * nl * sx);
*x = (double)(xc + n + (line * sx));
*y = (double)(yc + ((sample + absOffset[block-1]) * sy));

return(0);

ERROR_HANDLE:

*x = -1e-9;
*y = -1e-9;
return(1);
}

```

A.7.5 misrproj.h

```

#ifndef MISRPROJ_H
#define MISRPROJ_H

/* Defines */

#define STRLEN 200
#define NBLOCK 180
#define NOFFSET NBLOCK - 1
#define R2D 57.2957795131
#define D2R 1.745329251994328e-2
#define NPROJ 13

/* Prototypes */

int misr_init(
const int nblock, /* Number of blocks */
const int nline, /* Number of lines in a block */
const int nsample, /* Number of samples in a block */
const float relOff[NOFFSET], /* Block offsets */
const double ulc_coord[], /* Upper left corner coord. in meters */
const double lrc_coord[] /* Lower right corner coord. in meters */
);

int misrfor(
const double x, /* Output SOM X coordinate */
const double y, /* Output SOM Y coordinate */
int* block, /* Input block */
float* line, /* Input line */
float* sample /* Input sample */
);

int misrinv(
const int block, /* Input block */
const float line, /* Input line */
const float sample, /* Input sample */
double* x, /* Output SOM X coordinate */
double* y /* Output SOM Y coordinate */
);

#endif /* MISRPROJ_H */

```

A.7.6 errormacros.h

```

#ifndef ERRORMACROS_H

```



```

#define ERRORMACROS_H

#include <stdio.h>

#define HDFEOS_ERROR_CHECK(msg) \
    if (hdfEOS_status_code == FAIL) { \
        fprintf(stderr, "Error: %s at line %d\n", msg, __LINE__); \
        exit(1); \
    }

#define MEM_ERROR_CHECK(msg) \
    if (mem_status_code == NULL) { \
        fprintf(stderr, "Error: %s at line %d\n", msg, __LINE__); \
        exit(1); \
    }

#define ERROR(msg) \
    { \
        fprintf(stderr, "Error: %s at line %d\n", msg, __LINE__); \
        exit(1); \
    }

#ifdef MISRWARN
#define WRN_LOG_JUMP(msg) \
    { \
        fprintf(stderr, "Warning: %s in %s <Line: %d>\n", \
            msg, FUNC_NAME, __LINE__); \
        goto ERROR_HANDLE; \
    }
#else
#define WRN_LOG_JUMP(msg) goto ERROR_HANDLE;
#endif

#endif /* ERRORMACROS_H */

```

A.7.7 Makefile

```

CC= gcc
CFLAGS= -g -n32 -DMISRWARN -I$(HDFINC) -I$(HDFEOS_INC)
CFLGAS= -g -n32 -I$(HDFINC) -I$(HDFEOS_INC)
LDLFLAS= -L$(HDFEOS_LIB) -L$(HDFLIB) \
        -lhdfEOS -lGctp -lmfhdf -ldf -ljpeg -lz -lm

OBJS=misr_init.o \
    misrinv.o \
    misrfor.o

all: misrcoordex

misrcoordex: misrcoordex.o $(OBJS)
    $(CC) $(CFLGAS) -o $@ $@.o $(OBJS) $(LDLFLAS)

clean:
    /bin/rm -f misrcoordex misrcoordex.o $(OBJS)

misrcoordex.o $OBJS: misrproj.h errormacros.h

```

A.8 Appendix A Bibliography

- [1] Lewicki, Scott, et. al., MISR Data Products Specifications -- Incorporating the Science Data Processing Interface Control Document, aka the MISR DPS, JPL D-13963, Revision D, February, 2002. (http://eosweb.larc.nasa.gov/PRODOCS/misr/readme/dps_ne_icd.pdf)
- [2] Snyder, John, Map Projections--A Working Manual, USGS Professional Paper 1395, 1987, Ch.

27, "Space Oblique Mercator Projection", pp. 214-229.

- [3] U.S. Geological Survey, National Mapping Division, GCTP General Cartographic Transformation Package Software Documentation, 1993.
- [4] Klein, Larry, HDF-EOS Library Users Guide for the ECS Project, Volume 2: Function Reference Guide, 170-TP-501-001, June, Raytheon Systems Company, upper Marlboro, MD, 1998, pages I-7 through I-12 and 2-152. (http://ivanova.gsfc.nasa.gov/hdfeos/HDF-EOS_REF.pdf)

